

Technical Characteristics SMB

Technische Daten SMB

| Electrical characteristics | | Elektrische Daten | |
|----------------------------|------------------------|---------------------------------|--|
| Characteristic impedance | 50 Ω | Wellenwiderstand | |
| Frequency range | 0...4 GHz | Frequenzbereich | |
| VSWR (straight contacts) | ≤ 1.30 typ. | VSWR (gerader Kontakt) | |
| Insertion loss (dB) | 0.1 dB max. /1GHz typ. | Dämpfung (dB) | |
| Insulation resistance | 1000 MΩ | Isolationswiderstand | |
| Center contact resistance | ≤ 5.0 mΩ | Übergangswiderstand Innenleiter | |
| Outer contact resistance | ≤ 2.5 mΩ | Übergangswiderstand Außenleiter | |
| Test voltage | 750 V rms | Prüfspannung | |
| Working voltage | 150 V rms | Betriebsspannung | |
| Contact current | 1.5 A DC typ. | Strombelastbarkeit | |

| Mechanical characteristics | | Mechanische Daten | |
|--------------------------------|-----------|------------------------|--|
| Engagement force | 25 N max. | Einsteckkraft | |
| Disengagement force | 12 N min. | Ausziehkraft | |
| Center contact retention force | 20 N min. | Innenleiter Haltekraft | |
| Connecting operations | ≥ 500 | Anzahl Steckzyklen | |

| Environmental | | Umgebungseinflüsse | |
|-------------------|-------------------------|--------------------|--|
| Temperature range | -65°C - +155°C | Temperaturbereich | |
| Vibration | MIL-STD-202 Meth. 204/B | Vibration | |
| Humidity | MIL-STD-202 Meth. 106/D | Feuchtigkeit | |
| Shock | MIL-STD-202 Meth. 213/B | Schock | |
| Temperature cycle | MIL-STD-202 Meth. 102/C | Temperatur Zyklen | |

| Materials | | Materialien | |
|-----------------------------|-------------|------------------------------------|--|
| Body | Brass | Außenleiter | |
| Center contact - plug | Brass | Innenleiter - Stecker | |
| Center contact - jack | CuBe 2 | Innenleiter - Kuppler | |
| Spring | CuBe 2 | fedemde Kontaktteile | |
| Insulator | PTFE | Isolator | |
| Crimping sleeve | soft copper | Krimphülse | |
| Gaskets | Rubber | Dichtungen | |
| Plating body contact area | Au | Oberfläche Kontaktzone Außenleiter | |
| Plating center contact area | Au | Oberfläche Kontaktzone Innenleiter | |

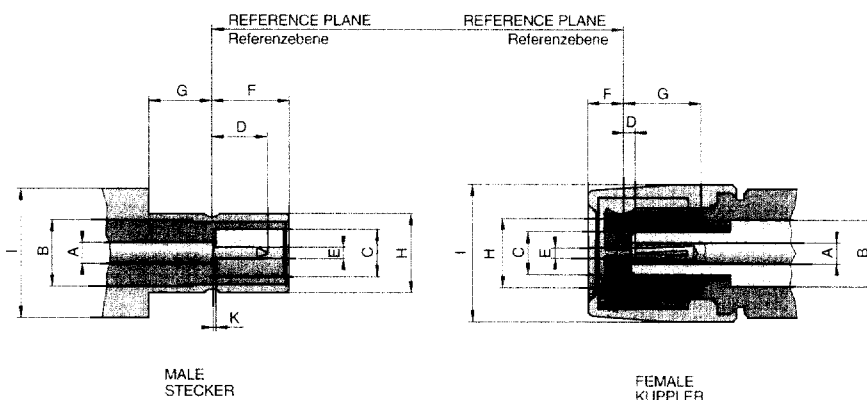

| SMB (50 Ohm) Serie 59 | | | | | |
|-----------------------|----------|------|----------|------|---|
| | MALE | | FEMALE | | |
| | STECKER | | KUPPLER | | |
| | min. | max. | min. | max. | |
| A | 0.95 nom | | 0.95 nom | | A |
| B | 3.05 nom | | 3.05 nom | | B |
| C | 2.08 | | 2.06 | | C |
| D | | 2.97 | 0.18 | 0.94 | D |
| E | 0.48 | 0.53 | | 1) | E |
| F | 3.33 | 3.58 | | 1.63 | F |
| G | 1.65 | | 3.58 | | G |
| H | 3.66 | 3.71 | | 1) | H |
| I | | 6.50 | | 6.50 | I |
| K | 0.0 | 0.18 | | | |

1) resilient. dim. to meet electrical and mechanical requirements
 federn d. zusammenggezogen (Erfüllung elektr./mech. Forderungen)

STRAIGHT PLUG, Clamp

STECKER, klemm

| Part Number | Cable Group | Assembly Instruction | MIL-Std - C39012 | Remarks |
|-----------------|-------------|----------------------|------------------|---------|
| 59 S 101-001 D3 | 01 | 59 A | 68-0003 | |
| 59 S 101-002 D3 | 02 / 03 | 59 A | 68-0004 | |

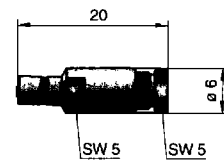

STRAIGHT PLUG, Solder

STECKER, löt

| Part Number | Cable Group | Assembly Instruction | MIL-Std - C39012 | Remarks |
|-----------------|-------------|----------------------|------------------|---------|
| 59 S 101-271 D3 | 71 | 59 K | | |

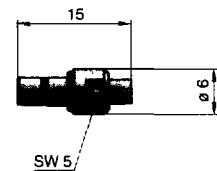

STRAIGHT PLUG, Crimp

STECKER, crimp

| Part Number | Cable Group | Assembly Instruction | MIL-Std - C39012 | Crimp-Insert | Remarks |
|-----------------|-------------|----------------------|------------------|--------------|---------|
| 59 S 101-101 D3 | 01 | 59 G2 | 68-0008 | 11 W 150-401 | |
| 59 S 101-102 D3 | 02 | 59 G2 | 68-0009 | 11 W 150-402 | |
| 59 S 101-103 D3 | 03 | 59 G2 | | 11 W 150-403 | |



BULKHEAD PLUG, Crimp Rear Mount

GEHÄUSESTECKER, Crimp Montage von hinten

| Part Number | Cable Group | Assembly Instruction | Panel Piercing | Crimp-Insert | Remarks |
|-----------------|-------------|----------------------|----------------|--------------|---------|
| 59 S 602-101 D3 | 01 | 59 G2 | B 22 | 11 W 150-401 | |
| 59 S 602-102 D3 | 02 | 59 G2 | B 22 | 11 W 150-402 | |
| 59 S 602-103 D3 | 03 | 59 G2 | B 22 | 11 W 150-403 | |



BULKHEAD PLUG, Solder, Rear Mount GEHÄUSESTECKER, löt, Montage von hinten

| Part Number | Cable Group | Assembly Instruction | Panel Piercing | Remarks |
|-----------------|-------------|----------------------|----------------|---------|
| 59 S 501-271 D3 | 71 | 59 K | B 22 | |

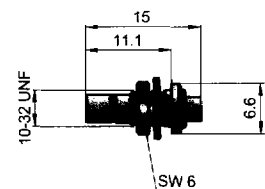

STRAIGHT JACK, Clamp

KUPPLER, klemm

| Part Number | Cable Group | Assembly Instruction | MIL-Std - C39012 | Remarks |
|-----------------|-------------|----------------------|------------------|---------|
| 59 K 101-001 D3 | 01 | 59 A | 67-0003 | |
| 59 K 101-002 D3 | 02,03 | 59 A | 67-0004 | |

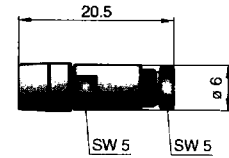

STRAIGHT JACK, Solder

KUPPLER, löt

| Part Number | Cable Group | Assembly Instruction | MIL-Std - C39012 | Remarks |
|-----------------|-------------|----------------------|------------------|---------|
| 59 K 101-271 D3 | 71 | 59 K | | |

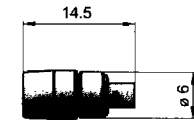

STRAIGHT JACK, Crimp

KUPPLER, crimp

| Part Number | Cable Group | Assembly Instruction | MIL-Std - C39012 | Crimp-Insert | Remarks |
|-----------------|-------------|----------------------|------------------|--------------|---------|
| 59 K 101-101 D3 | 01 | 59 G2 | 67-0008 | 11 W 150-401 | |
| 59 K 101-102 D3 | 02 | 59 G2 | 67-0009 | 11 W 150-402 | |
| 59 K 101-103 D3 | 03 | 59 G2 | | 11 W 150-403 | |

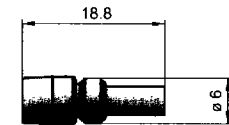

RIGHT ANGLE JACK, Clamp

WINKELKUPPLER, klemm

| Part Number | Cable Group | Assembly Instruction | MIL-Std - C39012 | Remarks |
|-----------------|-------------|----------------------|------------------|---------|
| 59 K 201-001 D3 | 01 | 59 C | 69-0003 | |
| 59 K 201-002 D3 | 02,03 | 59 C | 69-0004 | |

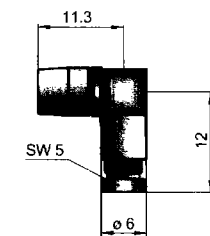

RIGHT ANGLE JACK, Solder

WINKELKUPPLER, löt

| Part Number | Cable Group | Assembly Instruction | MIL-Std - C39012 | Remarks |
|-----------------|-------------|----------------------|------------------|---------|
| 59 K 201-271 D3 | 71 | 59 K1 | | |

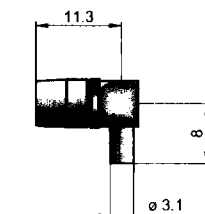

RIGHT ANGLE JACK, Crimp

WINKELKUPPLER, crimp

| Part Number | Cable Group | Assembly Instruction | MIL-Std. C39012 | Crimp Insert | Remark |
|-----------------|-------------|----------------------|-----------------|--------------|--------|
| 59 K 201-101 D3 | 01 | 59 H | 67-0008 | 11 W 150-402 | |
| 59 K 201-102 D3 | 02 | 59 H | 67-0009 | 11 W 150-402 | |
| 59 K 201-103 D3 | 03 | 59 H | | 11 W 150-402 | |

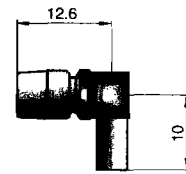

RIGHT ANGLE JACK, Solder-Crimp

WINKELKUPPLER, löt-crimp

| Part Number | Cable Group | Assembly Instruction | MIL-Std. C39012 | Crimp Insert | Remark |
|-----------------|-------------|----------------------|-----------------|--------------|--------|
| 59 K 204-301 D3 | 01 | 59 F | | 11 W 150-101 | |
| 59 K 204-302 D3 | 02 | 59 F | | 11 W 150-102 | |
| 59 K 204-303 D3 | 03 | 59 F | | 11 W 150-103 | |

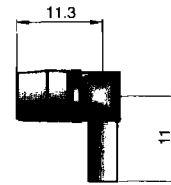

BULKHEAD PLUG, Front Mounting

GEHÄUSESTECKER, Montage von vorne

| Part Number | MIL-Std. C39012 | Panel Piercing | Remark |
|-----------------|-----------------|----------------|--------|
| 59 S 601-200 D3 | 71-0002 | B 22 | |

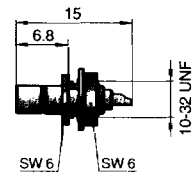

BULKHEAD PLUG, Rear Mounting

GEHÄUSESTECKER, Montage von hinten

| Part Number | MIL-Std. C39012 | Panel Piercing | Remark |
|-----------------|-----------------|----------------|--------|
| 59 S 602-200 D3 | 71-0001 | B 22 | |

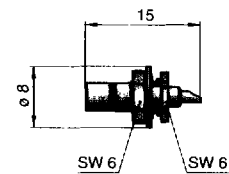

RIGHT ANGLE BULKHEAD PLUG

GEHÄUSE-WINKELSTECKER

| Part Number | Panel Piercing | Remarks |
|-----------------|----------------|---------|
| 59 S 201-200 D3 | B 22 | |

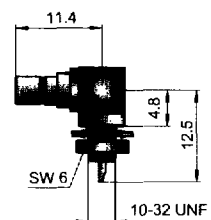

BULKHEAD PLUG

GEHÄUSESTECKER

| Part Number | MIL-Std - C39012 | Panel Piercing | Remarks |
|-----------------|---------------------|-------------------|---------|
| 59 S 605-200 D3 | | B 16 | |

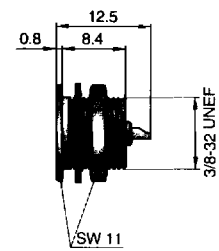

BULKHEAD JACK, Front Mounting

GEHÄUSEKUPPLER, Montage von vorne

| Part Number | MIL-Std - C39012 | Panel Piercing | Remarks |
|-----------------|---------------------|-------------------|---------|
| 59 K 601-200 D3 | | B 22 | |

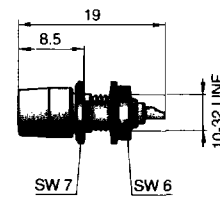

RIGHT ANGLE BULKHEAD JACK

GEHÄUSEWINKELKUPPLER

| Part Number | MIL-Std - C39012 | Panel Piercing | Remarks |
|-----------------|---------------------|-------------------|---------|
| 59 K 201-200 D3 | | B 22 | |

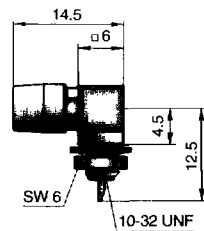

RIGHT ANGLE PANEL PLUG, Stripline

GEHÄUSEWINKELSTECKER, Stripline

| Part Number | MIL-Std - C39012 | Panel Piercing | Remarks |
|-----------------|---------------------|-------------------|-------------------------|
| 59 S 201-700 N4 | | B 55 | square flange, SMA size |

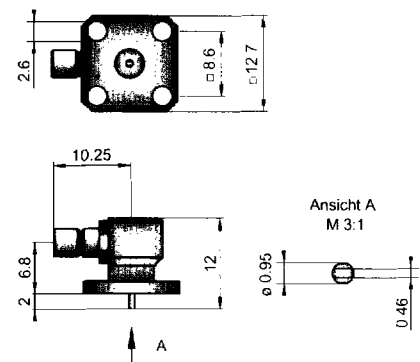

6

PANEL JACK, Stripline

GEHÄUSEKUPPLER, Stripline

| Part Number | MIL-Std | Panel Piercing | Remarks |
|-----------------|---------|----------------|-------------------|
| 59 K 402-700 N4 | C39012 | B 9 | square flange, 1" |

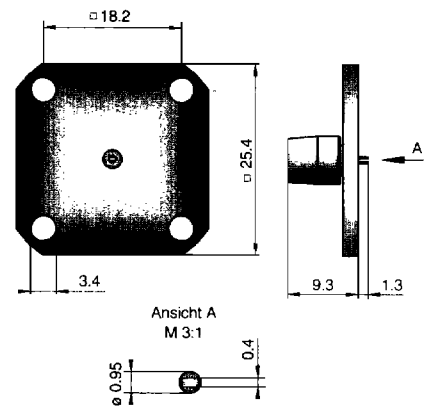

PLUG for PCB

LEITERPLATTENSTECKER

| Part Number | Panel Piercing | Remarks |
|-----------------|----------------|--------------------|
| 59 S 101-400 D3 | B 30 | a = 11.5; b = 7.5 |
| 59 S 102-400 D3 | B 30 | a = 16.5; b = 13.0 |

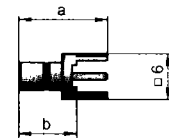

PRESS-FIT PLUG for PCB

PRESS-FIT-LEITERPLATTENSTECKER

| Part Number | Panel Piercing | Remarks |
|-----------------|----------------|---------|
| 59 S 102-40P E3 | B 79 | |

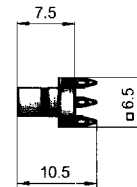

RIGHT ANGLE PLUG for PCB

LEITERPLATTEN-WINKELSTECKER

| Part Number | Panel Piercing | Remarks |
|-----------------|----------------|---------------------------|
| 59 S 201-400 D3 | B 30 | a = 11.4; b = 3; c = 11.5 |
| 59 S 212-400 D3 | B 30 | a = 12.7; b = 4; c = 10.5 |

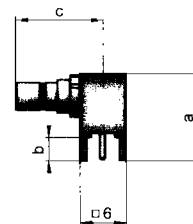

RIGHT ANGLE PLUG for PCB

LEITERPLATTEN-WINKELSTECKER

| Part Number | Panel Piercing | Remarks |
|-----------------|----------------|---------|
| 59 S 206-400 D3 | B 30 | |

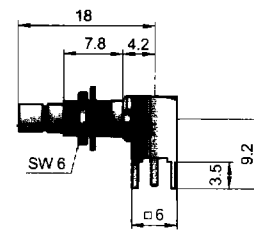

RIGHT ANGLE PLUG for PCB

LEITERPLATTEN-WINKELSTECKER

| Part Number | Panel Piercing | Remarks |
|-----------------|----------------|-----------------------|
| 59 S 213-40T D3 | B 30 | washable / waschdicht |

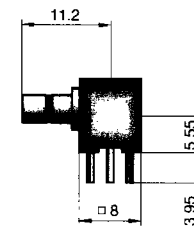

PRESS-FIT RIGHT ANGLE PLUG for PCB

PRESS-FIT LEITERPLATTEN-WINKELSTECKER

| Part Number | Panel Piercing | Remarks |
|-----------------|----------------|---------|
| 59 S 201-40P D3 | B 79 | |

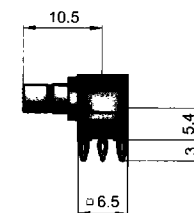

JACK for Printed Circuit Boards

LEITERPLATTENKUPPLER

| Part Number | Panel Piercing | Remarks |
|-----------------|----------------|-------------------|
| 59 K 101-400 D3 | B 30 | a = 13.5; b = 9.5 |
| 59 K 102-400 D3 | B 30 | a = 12.2; b = 8.2 |

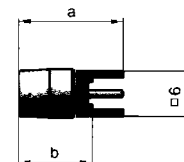

RIGHT ANGLE JACK for PCB

LEITERPLATTEN-WINKELKUPPLER

| Part Number | Panel Piercing | Remarks |
|-----------------|----------------|---------|
| 59 K 201-400 D3 | B 30 | |

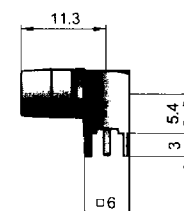

TERMINATION PLUG

ABSCHLUSS-STECKER

| Part Number | Technical information | Remarks |
|-------------|-----------------------|---------|
|-------------|-----------------------|---------|

59 S 155-025 D3 0.25 W; 0-1 GHz



TERMINATION JACK

ABSCHLUSS-KUPPLER

| Part Number | Technical information | Remarks |
|-------------|-----------------------|---------|
|-------------|-----------------------|---------|

59 K 155-025 D3 0.25 W; 0-1 GHz



STRAIGHT ADAPTOR

VERBINDER gerade

| Part Number | Remarks |
|-------------|---------|
|-------------|---------|

59 S 101-S00 D3 2 x plug

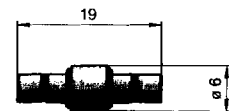

BULKHEAD ADAPTOR

GEHÄUSEVERBINDER

| Part Number | Remarks |
|-------------|---------|
|-------------|---------|

59 S 601-S00 D3 2 x plug

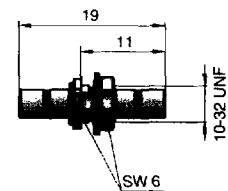

STRAIGHT ADAPTOR

VERBINDER gerade

| Part Number | Remarks |
|-------------|---------|
|-------------|---------|

59 K 101-K00 D3 2 x jack

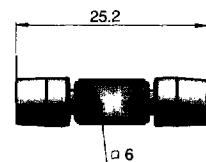

STRAIGHT ADAPTOR

VERBINDER gerade

| Part Number | Remarks |
|-------------|---------|
|-------------|---------|

59 S 101-K00 D3 1 x plug; 1 x jack

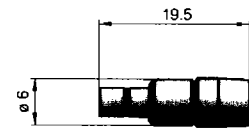

T-ADAPTOR

T-VERBINDER

| Part Number | Remarks |
|-------------|---------|
|-------------|---------|

59 S 301-S00 D3 3 x plug

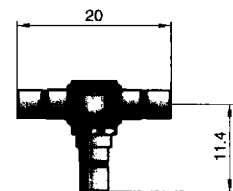

T-ADAPTOR

T-VERBINDER

| Part Number | Remarks |
|-------------|---------|
|-------------|---------|

59 S 301-K00 D3 2 x plug, 1 x jack

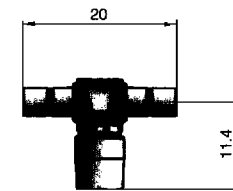

T-ADAPTOR

T-VERBINDER

| Part Number | Remarks |
|-------------|---------|
|-------------|---------|

59 K 301-K00 D3 3 x jack

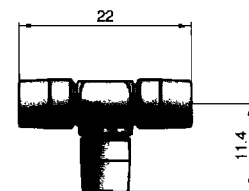

T-ADAPTOR

T-VERBINDER

| Part Number | Remarks |
|-------------|---------|
|-------------|---------|

59 K 301-S00 D3 2 x jack, 1 x plug

