

**Features**

- Highly precision: -0.7%~+0.5% (25°C); ± 1%(-10°C to 60°C, for PT7M62xxxx); ± 1.5%(-10°C to 60°C, for PT7M62xxxxB)
- Low power consumption: 0.9uA @ 3V Vcc
- Detect voltage range: 1.8 to 5V in 100mV increments
- Operating voltage range: 1.2V ~ 5.5V
- Output configuration: N-channel open drain or CMOS
- Special threshold voltage product according to customer need

**Description**

The PT7M62xx serials of ultra-low-power voltage detectors monitor battery, power-supply and system voltages. Each circuit includes a precision bandgap reference, a comparator, internally trimmed resistor networks that set specified trip thresholds, and an internal 5% threshold hysteresis circuit. Output is asserted when V<sub>CC</sub> rises above V<sub>TH+</sub> (V<sub>TH+</sub> = V<sub>TH</sub> × 1.05) and remains asserted until V<sub>CC</sub> falls below the internal V<sub>TH</sub>. These devices provide excellent circuit reliability and low cost by eliminating external components and adjustments when monitoring nominal system voltages from +1.8V to +5V in 100mV increments. The series are voltage detectors with a propagation delay of 20μs(V<sub>CC</sub> rise).

The family is available with three output stage options: push-pull with active-low output, push-pull with active-high output, and open drain with active-low output.

**Ordering Information**

Part Number	Package
PT7M62xxCLXTA3EX	Lead free SOT23-3
PT7M62xxCLXTA5EX	Lead free SOT23-5
PT7M62xxCLXC3EX	Lead free SC70-3
PT7M62xxCLXC4EX	Lead free SC70-4
PT7M62xxCLXNBEX	Lead free TO92
PT7M62xxCLXTDEX	Lead free SOT89
PT7M62xxCHXTA3EX	Lead free SOT23-3
PT7M62xxCHXTA5EX	Lead free SOT23-5
PT7M62xxCHXC3EX	Lead free SC70-3
PT7M62xxCHXTDEX	Lead free SOT89
PT7M62xxNLXTA3EX	Lead free SOT23-3
PT7M62xxNLXTA5EX	Lead free SOT23-5
PT7M62xxNLXC3EX	Lead free SC70-3
PT7M62xxNLXC4EX	Lead free SC70-4
PT7M62xxNLXNBEX	Lead free TO92
PT7M62xxNLXTDEX	Lead free SOT89
PT7M62xxCLLXNBEX	Lead free TO92
PT7M62xxNLLXNBEX	Lead free TO92

**Note 1:** “xx” refer to voltage range, see below table 1.

**Note 2:** “X” refer to accuracy, no suffix means that the accuracy is ±1.0% (-10°C to 60°C), B means that the accuracy is ±1.5% (-10°C to 60°C).

**Note 3:** “(E)X” refer to packing, no “X” means tube packing, adding “X” means tape and reel packing.

**Table 1 Suffix “xx” definition of PT7M62xx**

Suffix xx	V <sub>TH+</sub> (V)	Suffix xx	V <sub>TH+</sub> (V)	Suffix xx	V <sub>TH+</sub> (V)	Suffix xx	V <sub>TH+</sub> (V)	Suffix xx	V <sub>TH+</sub> (V)
18	1.8	25	2.5	32	3.2	39	3.9	46	4.6
19	1.9	26	2.6	33	3.3	40	4.0	47	4.7
20	2.0	27	2.7	34	3.4	41	4.1	48	4.8
21	2.1	28	2.8	35	3.5	42	4.2	49	4.9
22	2.2	29	2.9	36	3.6	43	4.3	50	5.0
23	2.3	30	3.0	37	3.7	44	4.4		
24	2.4	31	3.1	38	3.8	45	4.5		

**Table 2 Function comparison**

Item	Part No.	Reset Output				Threshold
		Open-Drain		Push-Pull		
		Active high	Active low	Active high	Active low	
1	PT7M62xxCL	-	-	-	√	1.8V to 5.0V in 100mV increments
2	PT7M62xxCLL	-	-	-	√	
3	PT7M62xxCH	-	-	√	-	
4	PT7M62xxNL	-	√	-	-	
5	PT7M62xxNLL	-	√	-	-	

**Block Diagram**

**Block Diagram of PT7M62xxCL/CH/CLL**

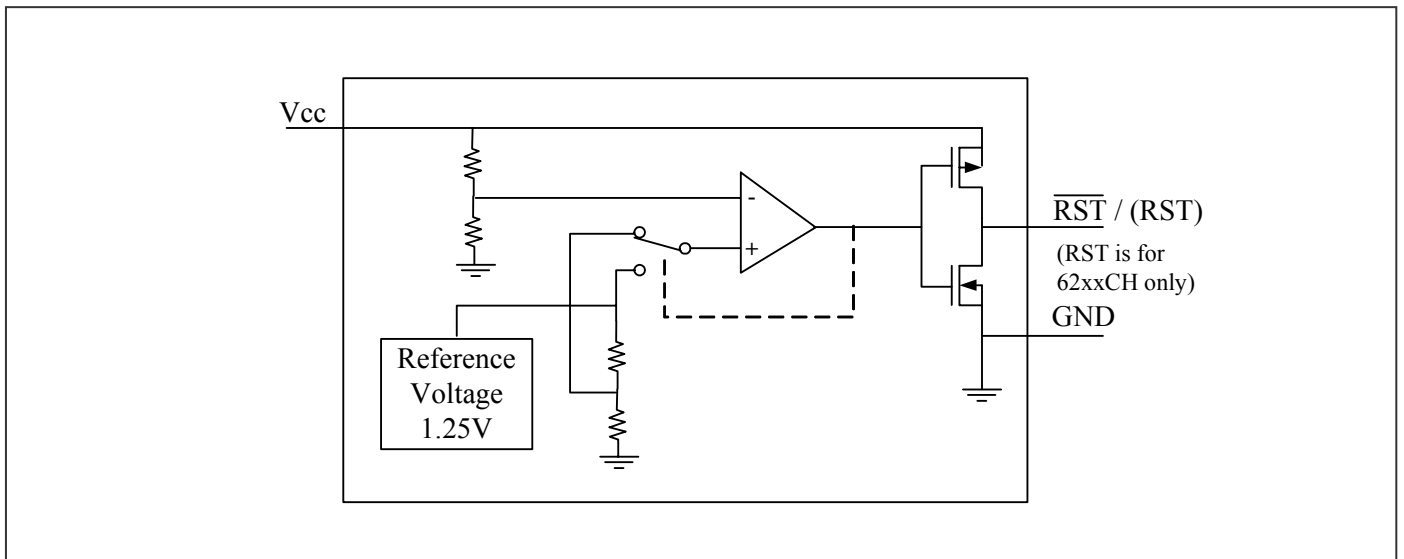

**Block Diagram of PT7M62xxNL/NLL**

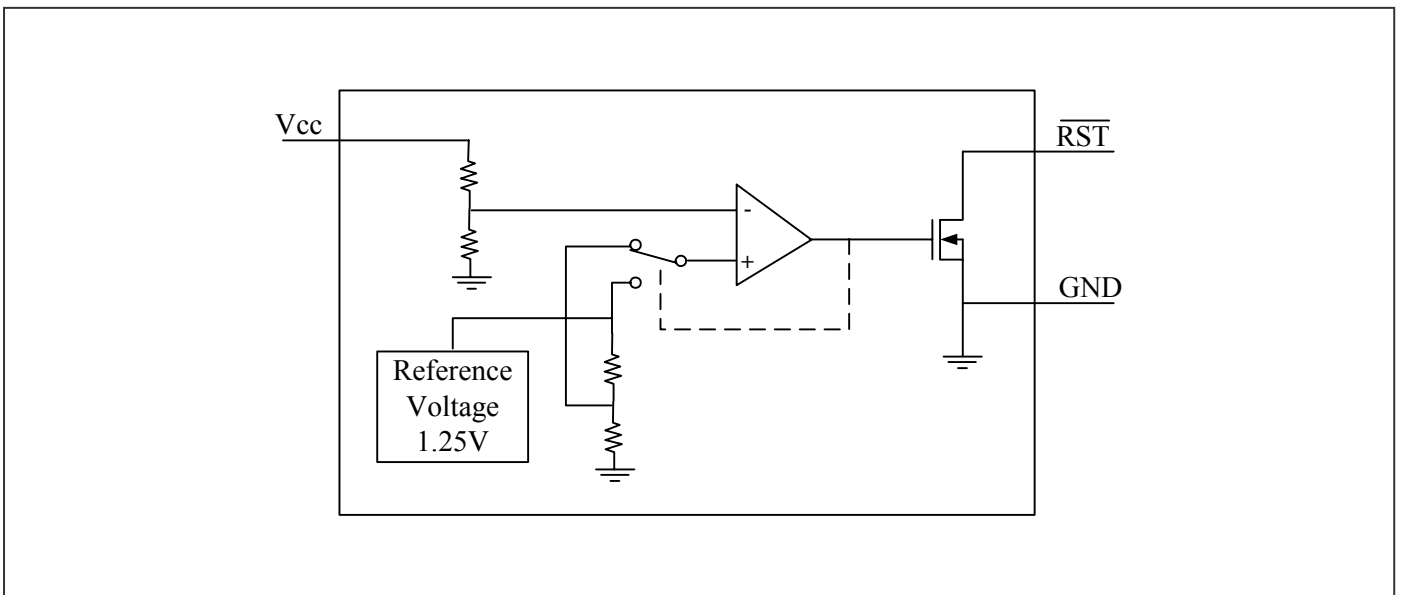

**Pin Configuration**

**PT7M62xxCLXC3  
PT7M62xxNLXC3**

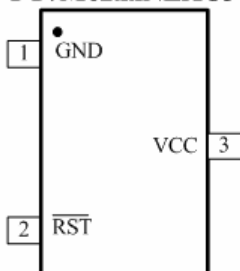

SC70-3

**PT7M62xxCLXTA3  
PT7M62xxNLXTA3**

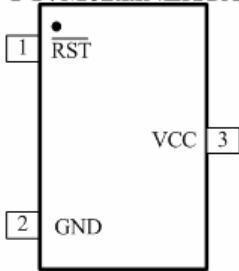

SOT23-3

**PT7M62xxCLXTA5  
PT7M62xxNLXTA5**

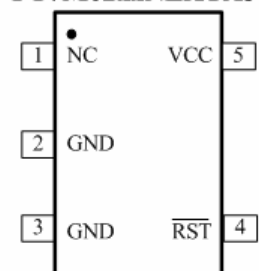

SOT23-5

**PT7M62xxCHXC3**

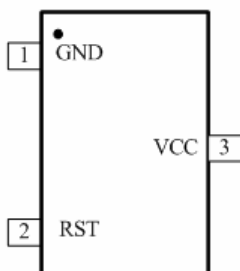

SC70-3

**PT7M62xxCHXTA3**

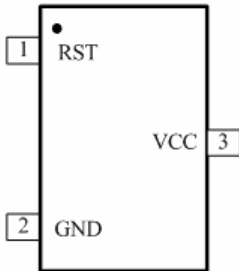

SOT23-3

**PT7M62xxCHXTA5**

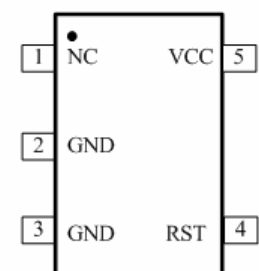

SOT23-5

**PT7M62xxCLXC4  
PT7M62xxNLXC4**

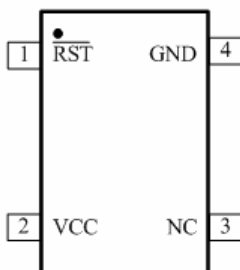

SC70-4

**PT7M62xxCLLXNB  
PT7M62xxNLLXNB**

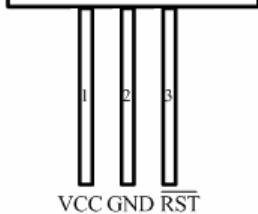

VCC GND RST  
TO-92

**PT7M62xxCLXNB  
PT7M62xxNLXNB**

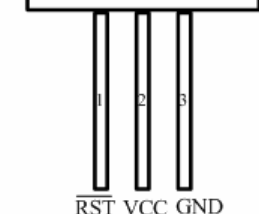

RST VCC GND  
TO-92

**PT7M62xxCHXTD**

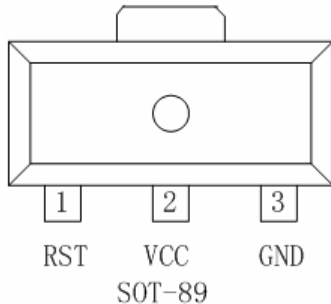

SOT-89

**PT7M62xxCLXTD  
PT7M62xxNLXTD**

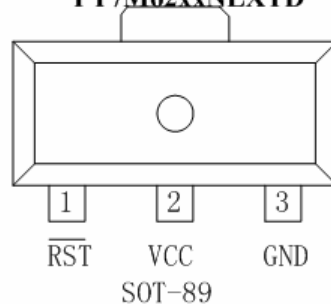

SOT-89

**Pin Description**

Name	Type	Description
$\overline{\text{RST}}$	O	<b>Reset Output (PT7M62xxCL/NL/CLL/NLL):</b> $\overline{\text{RST}}$ is asserted when $V_{CC}$ drops below voltage threshold $V_{TH}$ . Active low.
RST	O	<b>Reset Output (PT7M62xxCH).</b> RST is asserted when $V_{CC}$ drops below voltage threshold $V_{TH}$ . Active high.
GND	P	<b>Ground</b>
VCC	P	<b>Supply Voltage.</b>

**Typical Operation Circuit**

**PT7M62xxNL Application Example**

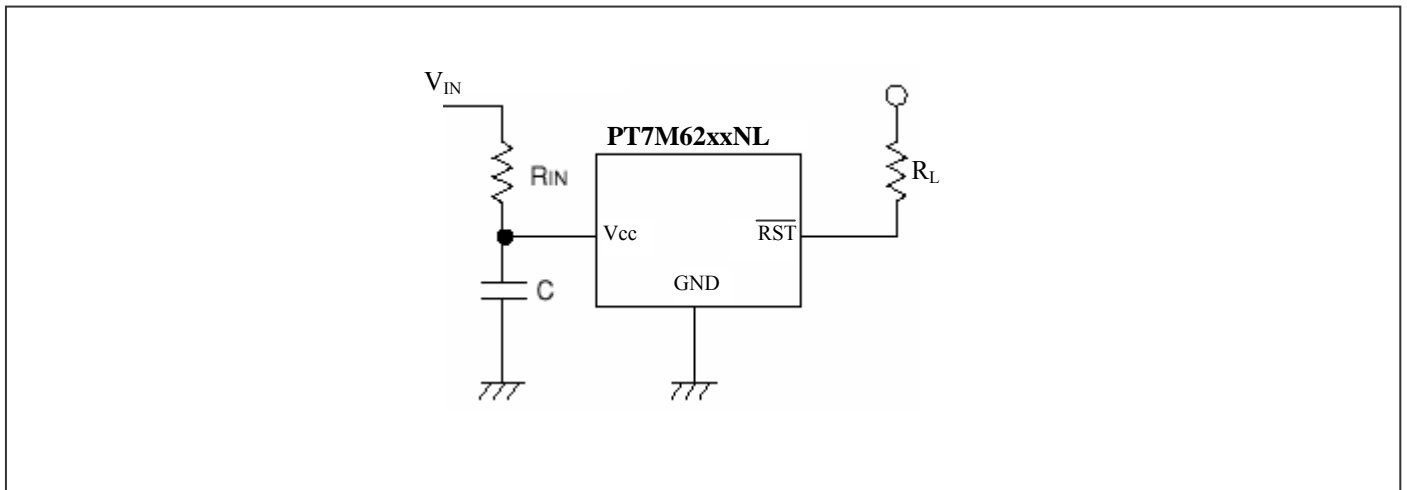

Please use N-ch open drains configuration, when a resistor  $R_{IN}$  is connected between the  $V_{CC}$  pin and power source  $V_{IN}$ . In such cases, please ensure that  $R_{IN}$  is less than 10k $\Omega$  and that  $C$  is more than 0.1 $\mu\text{F}$ .  $R_L$  could be 1k $\Omega$  to 510k $\Omega$ .

**Maximum Ratings**

Storage Temperature .....	-65°C to +150°C
Ambient Temperature with Power Applied.....	-40°C to +85°C
Supply Voltage to Ground Potential (Vcc to GND) .....	-0.3V to +6.0V
DC Input Voltage (All inputs except Vcc and GND).....	-0.3V to V <sub>CC</sub> +0.3V
DC Output Current (All outputs) .....	20mA
Power Dissipation .....	320mW (Depend on package)

**Note:**

Stresses greater than those listed under MAXIMUM RATINGS may cause permanent damage to the device. This is a stress rating only and functional operation of the device at these or any other conditions above those indicated in the operational sections of this specification is not implied. Exposure to absolute maximum rating conditions for extended periods may affect reliability.

**DC Electrical Characteristics**

(V<sub>CC</sub> = 1.2V to 5.5V, T<sub>A</sub> = -40~85°C, unless otherwise noted. Typical values are at T<sub>A</sub> = +25°C)

Description		Sym.	Test Conditions	Min	Typ	Max	Unit
Supply Voltage		V <sub>CC</sub>	T <sub>A</sub> = 0~70°C	1.0	-	5.5	V
			T <sub>A</sub> = -40~85°C	1.2	-	5.5	
Supply Current		I <sub>CC</sub>	V <sub>CC</sub> = 3V. No load.	-	0.9	3.0	μA
			V <sub>CC</sub> = 5V. No load.	-	1.3	3.6	μA
Output Driving	Output high	V <sub>OH</sub>	V <sub>CC</sub> ≥ 1.8V, I <sub>source</sub> = 1mA	0.8×V <sub>CC</sub>	-	-	V
			V <sub>CC</sub> ≥ 2.5V, I <sub>source</sub> = 3mA	0.8×V <sub>CC</sub>	-	-	
			V <sub>CC</sub> ≥ 4.5V, I <sub>source</sub> = 8mA	0.8×V <sub>CC</sub>	-	-	
	Output low	V <sub>OL</sub>	V <sub>CC</sub> ≥ 1.2V, I <sub>sink</sub> = 1mA	-	-	0.3	V
			V <sub>CC</sub> ≥ 2.5V, I <sub>sink</sub> = 4mA	-	-	0.3	
			V <sub>CC</sub> ≥ 4.5V, I <sub>sink</sub> = 9mA	-	-	0.4	
Open-Drain Output Leakage Current		I <sub>LKG</sub>	-	-	-	1	μA
Voltage Threshold		V <sub>TH+</sub>	+25°C	(V <sub>TH+</sub> ) ×0.993	V <sub>TH+</sub>	(V <sub>TH+</sub> ) ×1.005	V
			-10°C~60°C(PT7M62xxxxB )	(V <sub>TH+</sub> ) ×0.985	V <sub>TH+</sub>	(V <sub>TH+</sub> ) ×1.015	
			-10°C~60°C(PT7M62xxxx )	(V <sub>TH+</sub> ) ×0.99	V <sub>TH+</sub>	(V <sub>TH+</sub> ) ×1.01	
voltage threshold Hysteresis		V <sub>HYST</sub>	V <sub>HYST</sub> = [(V <sub>TH+</sub> )-(V <sub>TH-</sub> )]/(V <sub>TH-</sub> ) ×100%	3	5	6	%

**Note:** V<sub>TH-</sub> = V<sub>TH+</sub> / 1.05. V<sub>TH-</sub> is voltage threshold when Vcc falls from high to low. V<sub>TH+</sub> is voltage threshold when Vcc rises from low to high.

**AC Electrical Characteristics**

**Timing diagram**

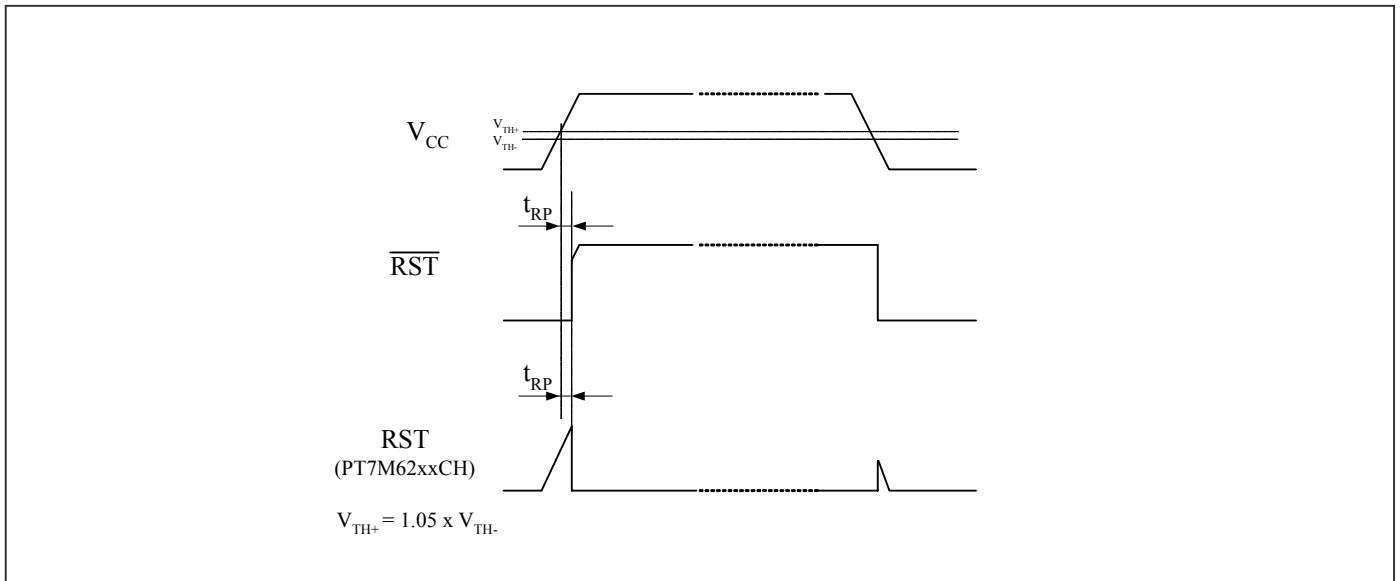

( $V_{CC} = 1.2V$  to  $5.5V$ ,  $T_A = -40 \sim 85^\circ C$ , unless otherwise noted. Typical values are at  $T_A = +25^\circ C$ )

Sym.	Description	Test Conditions	Min	Typ	Max	Unit
$t_{RP}$	Timeout Period	-	-	20	-	$\mu s$

**Mechanical Information**

TA3 (SOT23-3)

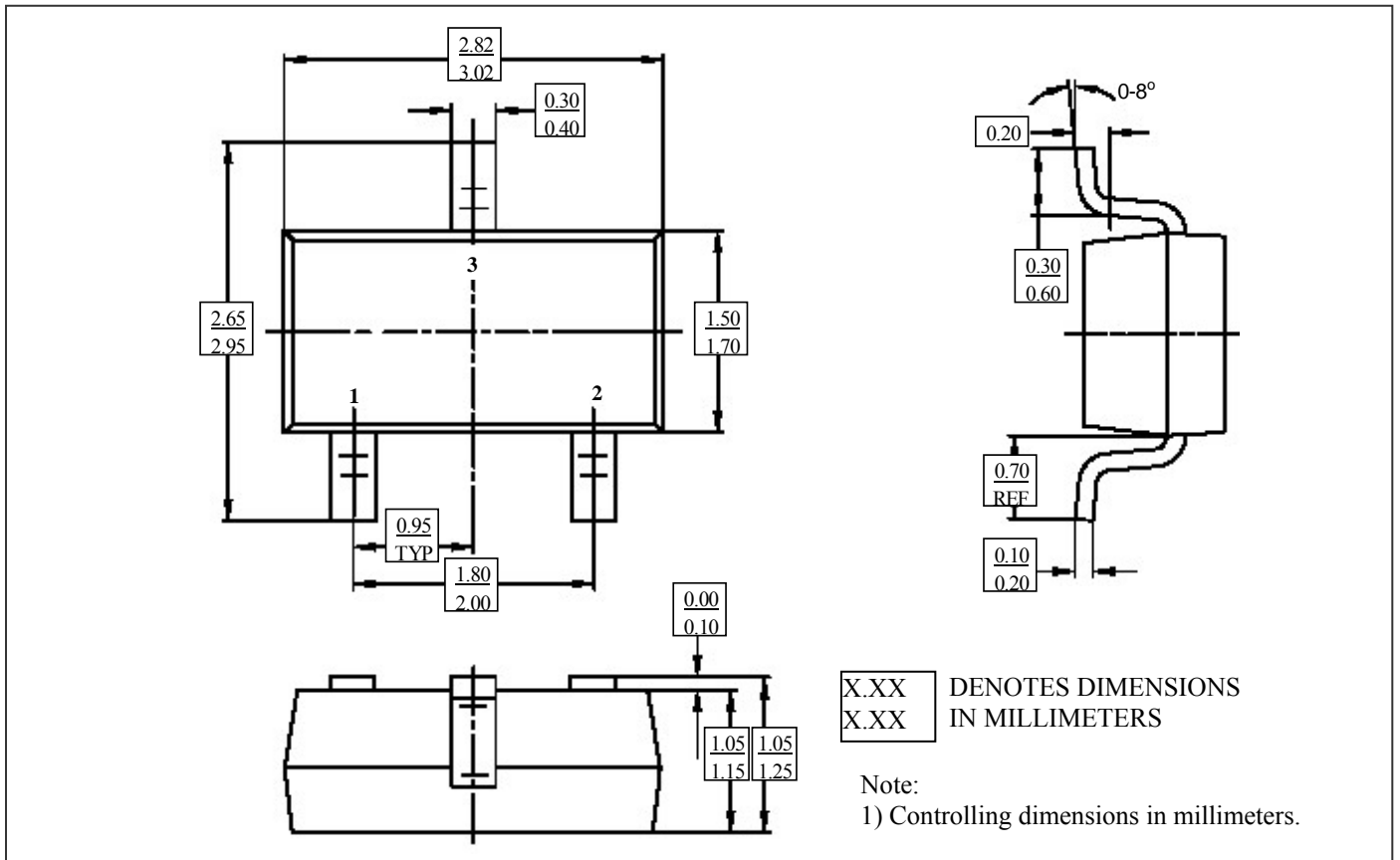

TA5 (SOT23-5)

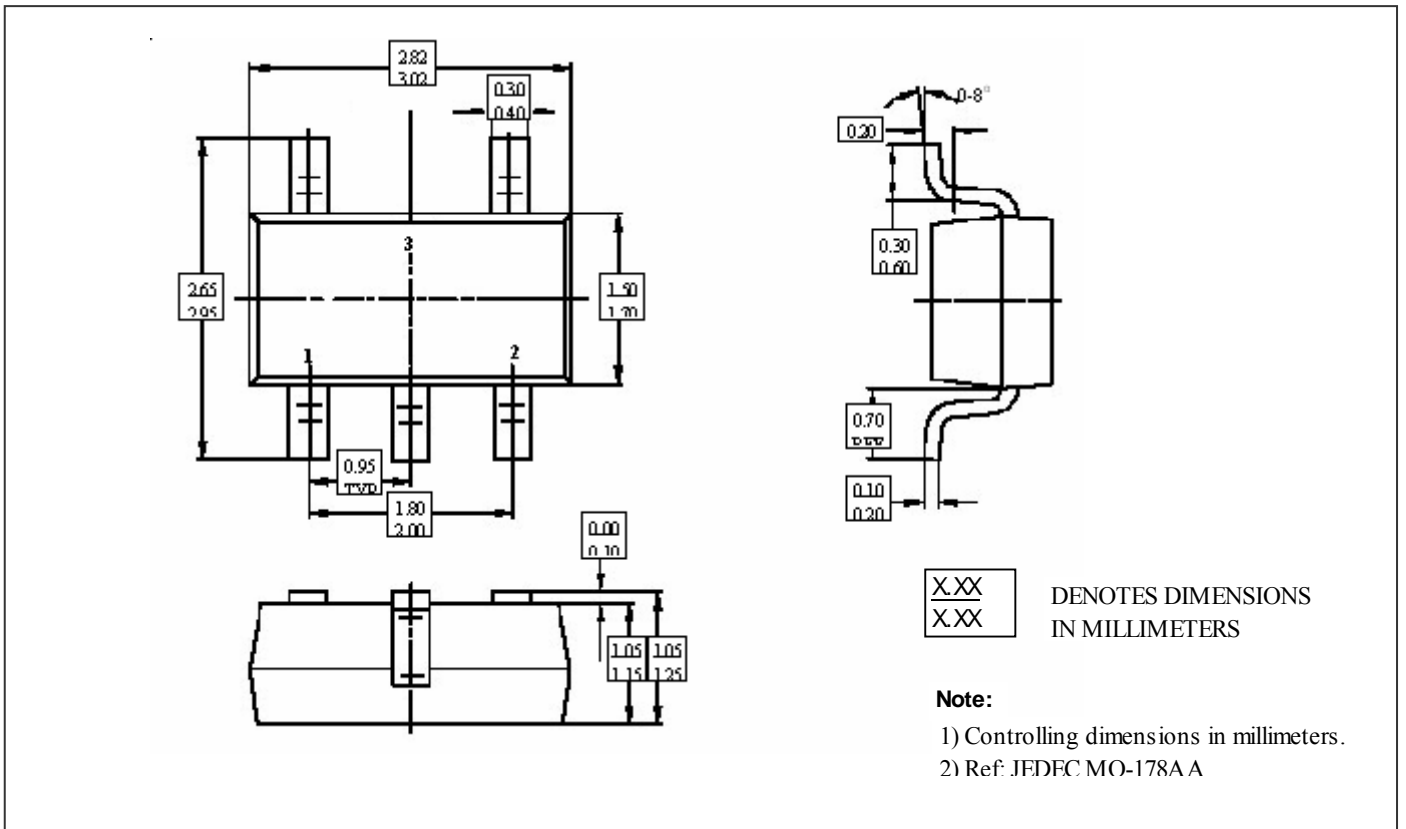

**NB (TO92)**

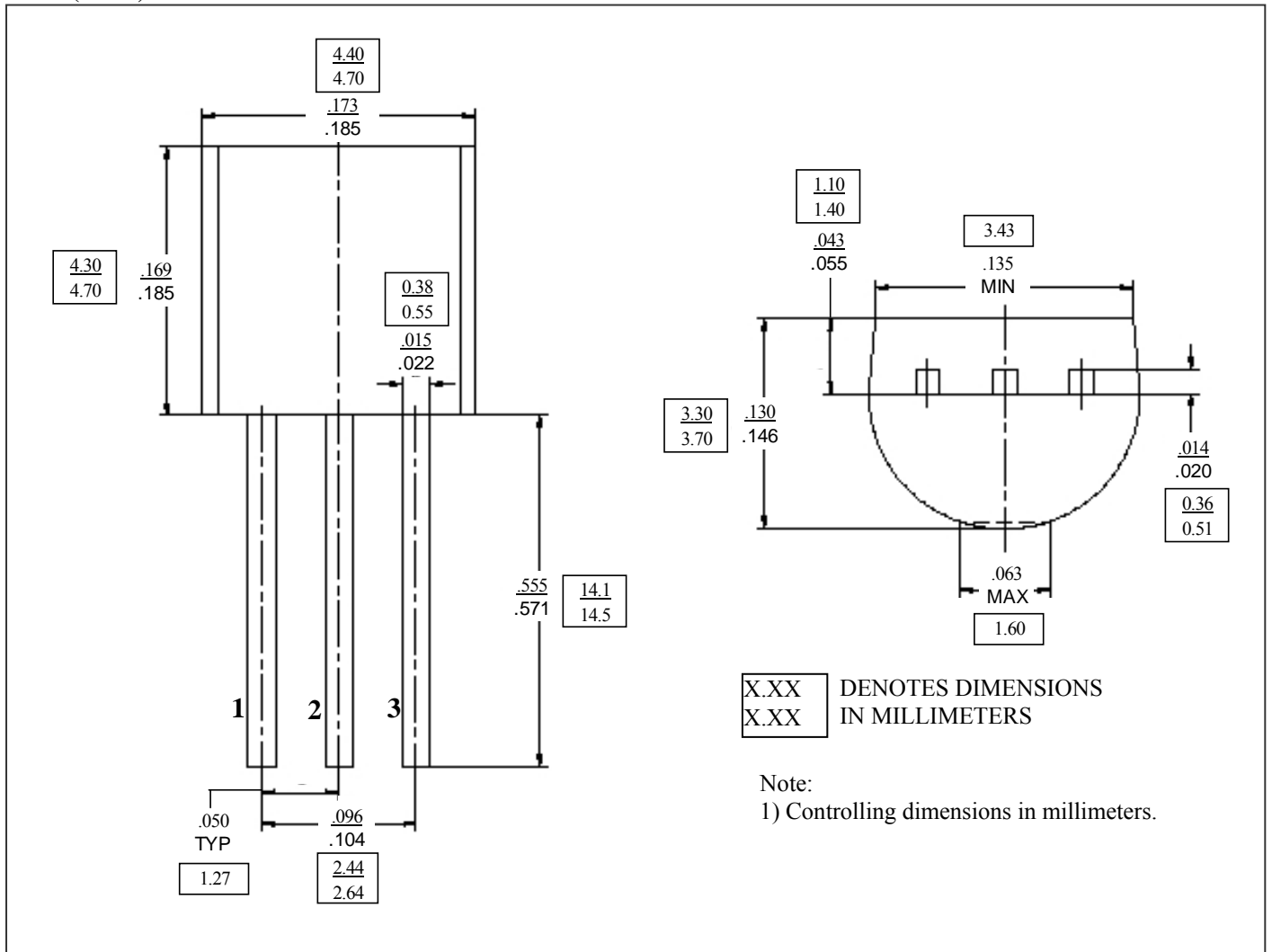



**C3 (SC70-3)**

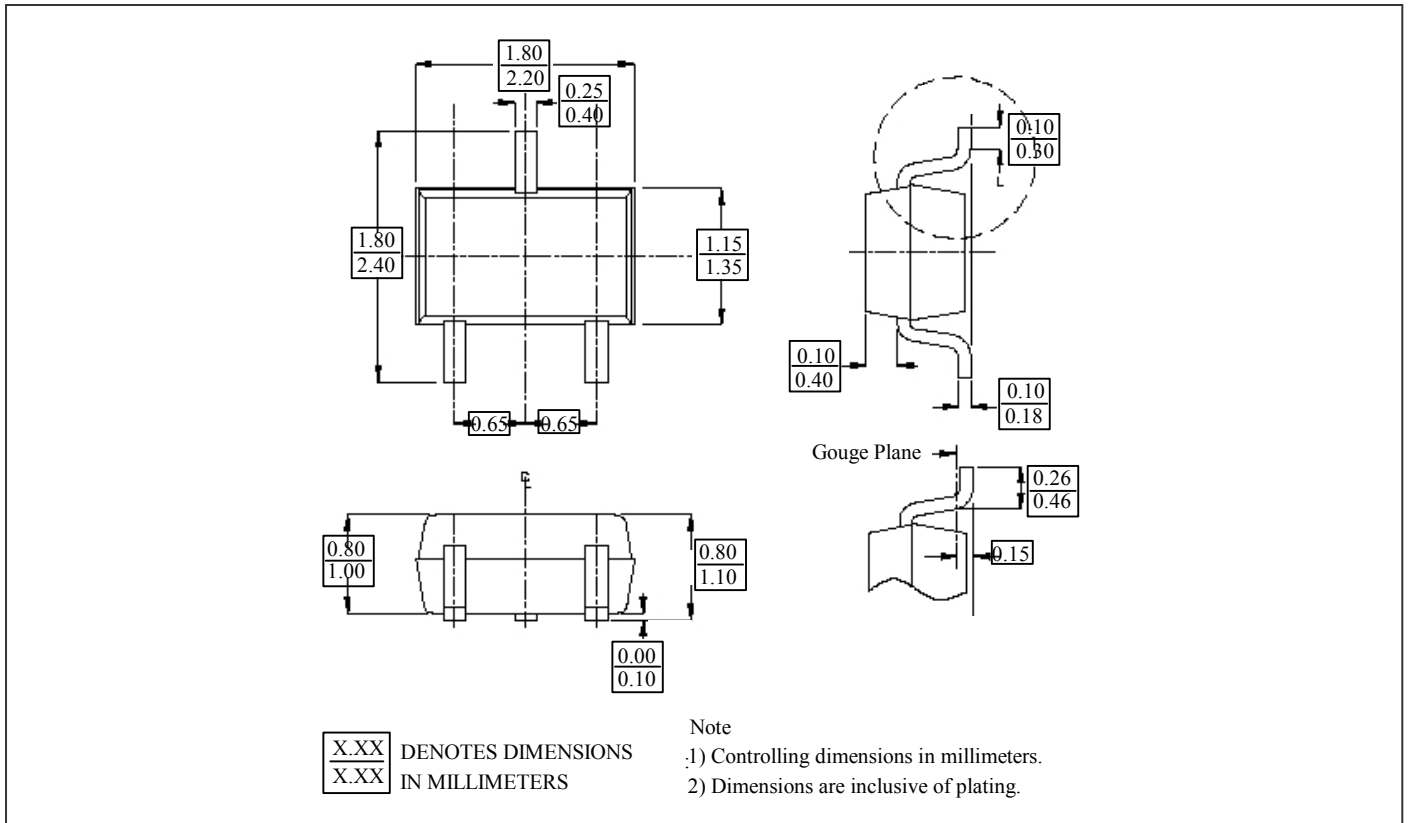

**C4 (SC70-4)**

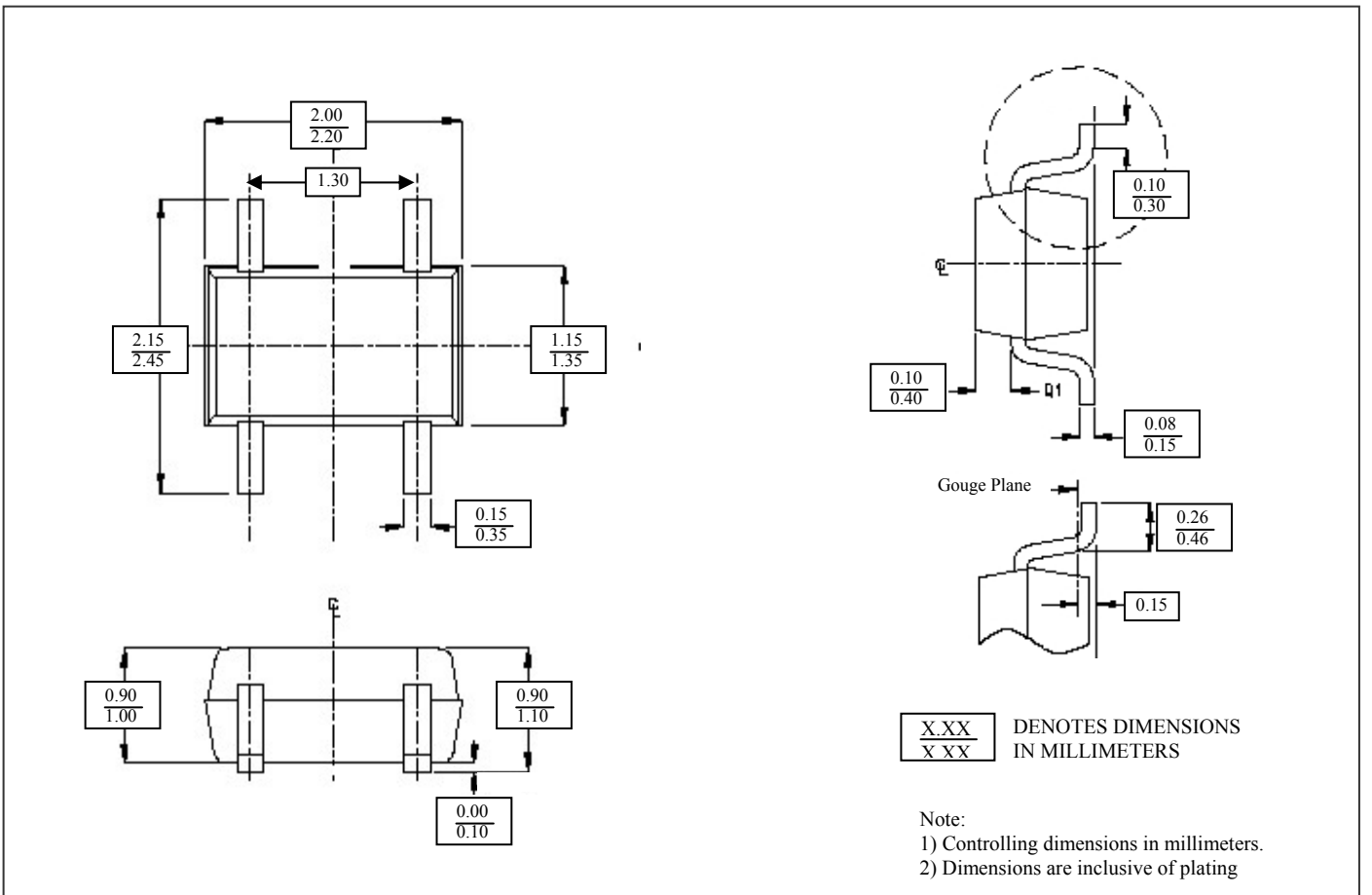

**TD (SOT89)**

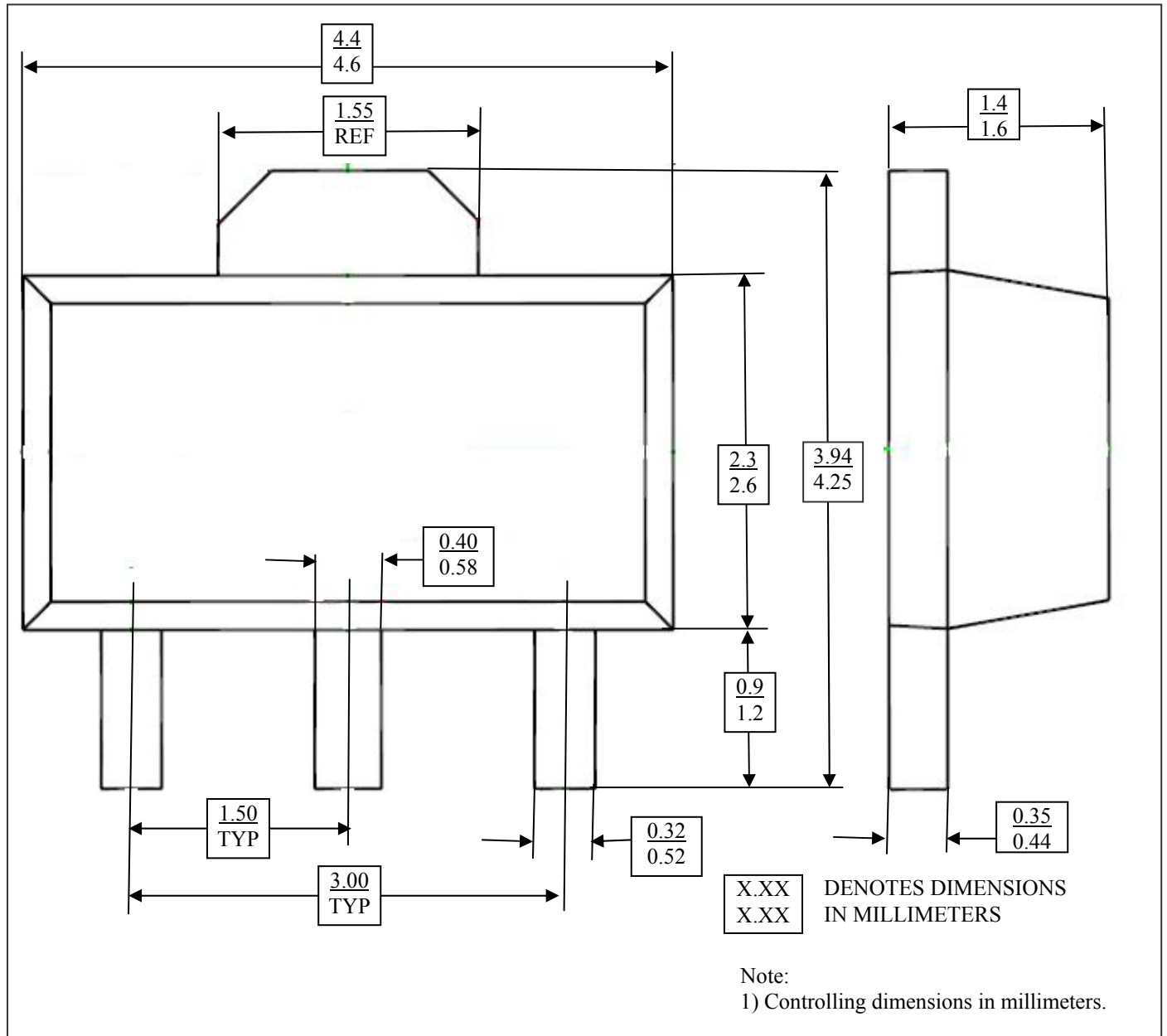

**SOT23/SC70/SOT143 Package Top Marking Instruction**

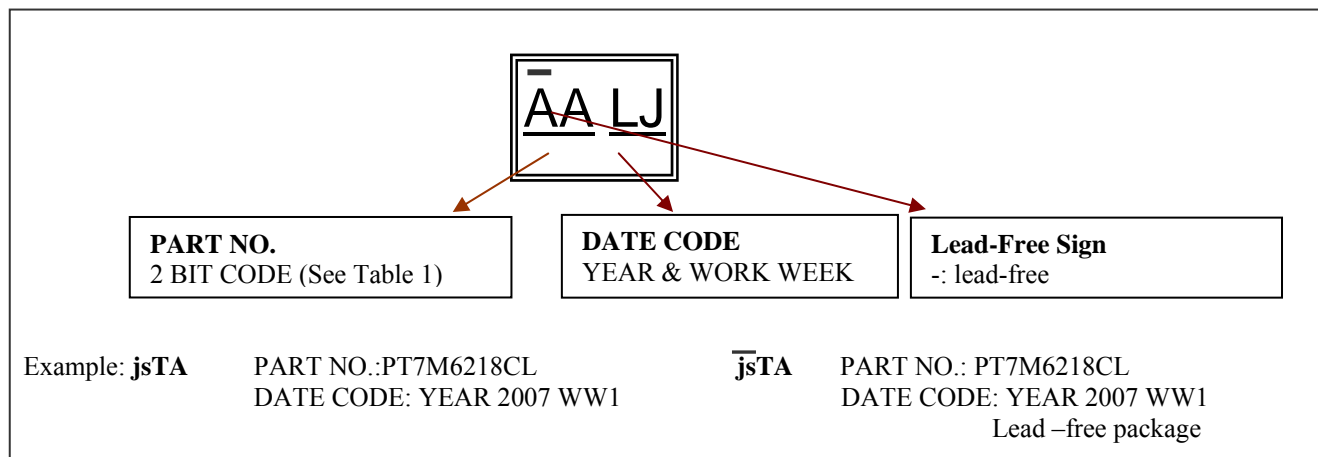

**Table 1 Part No code comparison table**

No.	Part No.	Code	No.	Part No.	Code	No.	Part No.	Code
1	PT7M6218CL	js	34	PT7M6229CL	kz	67	PT7M6240CL	mg
2	PT7M6218CH	jt	35	PT7M6229CH	la	68	PT7M6240CH	mh
3	PT7M6218NL	ju	36	PT7M6229NL	lb	69	PT7M6240NL	mi
4	PT7M6219CL	jv	37	PT7M6230CL	lc	70	PT7M6241CL	mj
5	PT7M6219CH	jw	38	PT7M6230CH	ld	71	PT7M6241CH	mk
6	PT7M6219NL	jx	39	PT7M6230NL	le	72	PT7M6241NL	ml
7	PT7M6220CL	jy	40	PT7M6231CL	lf	73	PT7M6242CL	mm
8	PT7M6220CH	jz	41	PT7M6231CH	lg	74	PT7M6242CH	mn
9	PT7M6220NL	ka	42	PT7M6231NL	lh	75	PT7M6242NL	mo
10	PT7M6221CL	kb	43	PT7M6232CL	li	76	PT7M6243CL	mp
11	PT7M6221CH	kc	44	PT7M6232CH	lj	77	PT7M6243CH	mq
12	PT7M6221NL	kd	45	PT7M6232NL	lk	78	PT7M6243NL	mr
13	PT7M6222CL	ke	46	PT7M6233CL	ll	79	PT7M6244CL	ms
14	PT7M6222CH	kf	47	PT7M6233CH	lm	80	PT7M6244CH	mt
15	PT7M6222NL	kg	48	PT7M6233NL	ln	81	PT7M6244NL	mu
16	PT7M6223CL	kh	49	PT7M6234CL	lo	82	PT7M6245CL	mv
17	PT7M6223CH	ki	50	PT7M6234CH	lp	83	PT7M6245CH	mw
18	PT7M6223NL	kj	51	PT7M6234NL	lq	84	PT7M6245NL	mx
19	PT7M6224CL	kk	52	PT7M6235CL	lr	85	PT7M6246CL	my
20	PT7M6224CH	kl	53	PT7M6235CH	ls	86	PT7M6246CH	mz
21	PT7M6224NL	km	54	PT7M6235NL	lt	87	PT7M6246NL	na
22	PT7M6225CL	kn	55	PT7M6236CL	lu	88	PT7M6247CL	nb
23	PT7M6225CH	ko	56	PT7M6236CH	lv	89	PT7M6247CH	nc
24	PT7M6225NL	kp	57	PT7M6236NL	lw	90	PT7M6247NL	nd
25	PT7M6226CL	kq	58	PT7M6237CL	lx	91	PT7M6248CL	ne
26	PT7M6226CH	kr	59	PT7M6237CH	ly	92	PT7M6248CH	nf
27	PT7M6226NL	ks	60	PT7M6237NL	lz	93	PT7M6248NL	ng
28	PT7M6227CL	kt	61	PT7M6238CL	ma	94	PT7M6249CL	nh
29	PT7M6227CH	ku	62	PT7M6238CH	mb	95	PT7M6249CH	ni
30	PT7M6227NL	63	PT7M6238NL	mc	96	PT7M6249NL	nj	
31	PT7M6228CL	kw	64	PT7M6239CL	md	97	PT7M6250CL	nk
32	PT7M6228CH	kx	65	PT7M6239CH	me	98	PT7M6250CH	nl
33	PT7M6228NL	ky	66	PT7M6239NL	mf	99	PT7M6250NL	nm

**Notes**

---

***Pericom Technology Inc.***

Email: support@pti.com.cn Web Site: www.pti.com.cn, www.pti-ic.com

**China:** No. 20 Building, 3/F, 481 Guiping Road, Shanghai, 200233, China  
Tel: (86)-21-6485 0576 Fax: (86)-21-6485 2181

**Asia Pacific:** Unit 1517, 15/F, Chevalier Commercial Centre, 8 Wang Hoi Rd, Kowloon Bay, Hongkong  
Tel: (852)-2243 3660 Fax: (852)- 2243 3667

**U.S.A.:** 3545 North First Street, San Jose, California 95134, USA  
Tel: (1)-408-435 0800 Fax: (1)-408-435 1100

Pericom Technology Incorporation reserves the right to make changes to its products or specifications at any time, without notice, in order to improve design or performance and to supply the best possible product. Pericom Technology does not assume any responsibility for use of any circuitry described other than the circuitry embodied in Pericom Technology product. The company makes no representations that circuitry described herein is free from patent infringement or other rights, of Pericom Technology Incorporation.