

## 10 A SLIM POWER RELAY

## LK-P RELAYS

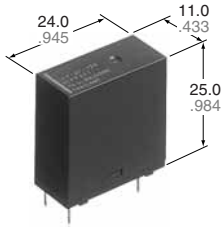

mm inch

### FEATURES

**1. High switching capacity: 10 A 277V AC**

**2. High insulation resistance between contact and coil**

1) Creepage distance and clearances between contact and coil: Min. 6 mm .236 inch (In compliance with IEC65)

2) Surge withstand voltage between contact and coil: 10,000 V or more

**3. High noise immunity realized by the card separation structure between contact and coil**

**4. Popular terminal pitch in AV equipment field**

**5. Space-saving slim type**

Base area: Width 11 × Length 24 mm  
Width .433 × Length .945 inch

**6. Conforms to the various safety standards**

UL/CSA, VDE, TÜV and SEMKO, SEV approved

Compliance with RoHS Directive

### SPECIFICATIONS

#### Contact

Arrangement	1 Form A	
Initial contact resistance, max. (By voltage drop 6 V DC 1 A)	Max. 100 mΩ	
Contact material	AgSnO <sub>2</sub> type	
Rating (resistive load)	Nominal switching capacity	10 A 277 V AC, 5 A 30V DC
	Max. switching power	2,770 V A, 150W
	Max. switching voltage	277 V AC, 30 V DC
	Max. switching current	10 A (AC), 5A (DC)
	Min. switching capacity <sup>#1</sup>	100 mA, 5 V DC
Expected life (min. operations)	Mechanical (at 180 cpm)	2 × 10 <sup>6</sup>
	Electrical (at 20 cpm) (at rated load)	10 <sup>5</sup>

#### Coil

Nominal operating power	530 mW
-------------------------	--------

#1 This value can change due to the switching frequency, environmental conditions, and desired reliability level, therefore it is recommended to check this with the actual load.

#### Remarks

- \* Specifications will vary with foreign standards certification ratings.
- \*1 Measurement at same location as "Initial breakdown voltage" section.
- \*2 Detection current: 10mA
- \*3 Wave is standard shock voltage of  $\pm 1.2 \times 50\mu s$  according to JEC-212-1981
- \*4 Excluding contact bounce time.
- \*5 Half-wave pulse of sine wave: 11 ms; detection time: 10  $\mu s$
- \*6 Half-wave pulse of sine wave: 6 ms
- \*7 Detection time: 10  $\mu s$
- \*8 Refer to 6. Conditions for operation, transport and storage mentioned in AMBIENT ENVIRONMENT.

#### Characteristics

Max. operating speed	20 cpm (at rated load)	
Initial insulation resistance*1	Min. 1,000 MΩ (at 500 V DC)	
Initial *2 breakdown voltage	Between open contacts	1,000 Vrms for 1 min.
	Between contact and coil	4,000 Vrms for 1 min.
Initial surge voltage between contact and coil*3	Min. 10,000 V	
Operate time*4 (at nominal voltage)	Max. 15 ms (at 20°C 68°F)	
Release time (without diode)*4 (at nominal voltage)	Max. 5 ms (at 20°C 68°F)	
Temperature rise (at 70°C)	Max. 45°C with nominal coil voltage and at 10 A contact carrying current (resistance method)	
Shock resistance	Functional*5	Min. 200 m/s <sup>2</sup> {approx. 20 G}
	Destructive*6	Min. 1,000 m/s <sup>2</sup> {approx. 100 G}
Vibration resistance	Functional*7	10 to 55Hz at double amplitude of 1.5mm
	Destructive	10 to 55Hz at double amplitude of 1.5mm
Conditions for operation, transport and storage*8 (Not freezing and condensing at low temperature)	Ambient temp.	-40°C to +70°C -40°F to +158°F
	Humidity	5 to 85% R.H.
	Air pressure	86 to 106 kPa
Unit weight	Approx. 12 g .42 oz	

### TYPICAL APPLICATIONS

- Audio visual equipment  
TVs, VTRs
- Office equipment  
LBP, CRT
- Home appliances  
Refrigerator, Air conditioner

### ORDERING INFORMATION

Ex. LKP 1a F - 12V

Contact arrangement	Protective construction	Coil voltage(DC)
1a: 1 Form A	F: Flux-resistant type	5, 6, 9, 12, 18, 24V

UL/CSA, TÜV, SEMKO, TV-5 approved type is standard.

Notes 1. Standard packing Carton: 100 pcs. Case: 500 pcs.

2. 5 V, 9 V, 18 V DC types are also available. Please consult us for details.

## TYPES AND COIL DATA (at 20°C 68°F)

Part No.	Nominal voltage, V DC	Pick-up voltage V DC (max.) (Initial)	Drop-out voltage V DC (min.) (Initial)	Coil resistance, Ω (±10%)	Nominal operating current, mA (±10%)	Nominal operating power, mW	Max. allowable voltage, V DC (at 20°C 68°F)
LKP1aF-5V	5	3.5	0.5	47	106.4	530	6.5
LKP1aF-6V	6	4.2	0.6	68	88.3	530	7.8
LKP1aF-9V	9	6.3	0.9	153	58.8	530	11.7
LKP1aF-12V	12	8.4	1.2	272	44.2	530	15.6
LKP1aF-18V	18	12.6	1.8	611	29.5	530	23.4
LKP1aF-24V	24	16.8	2.4	1,087	22.1	530	31.2

## DIMENSIONS

mm inch

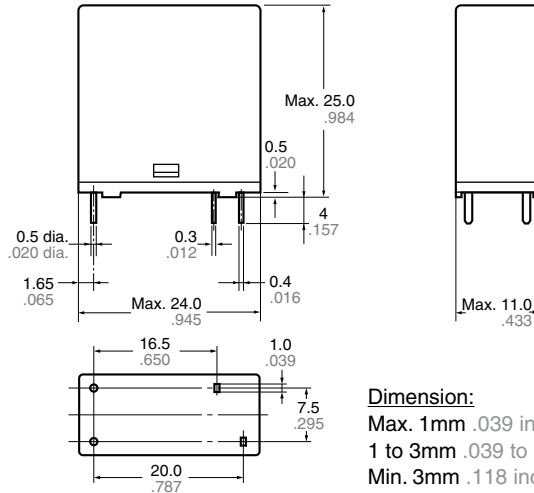

PC board pattern (Bottom view)

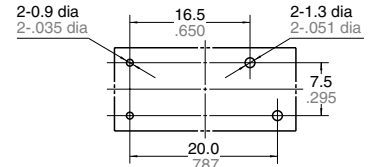

Tolerance: ±0.1 ±.004

Schematic (Bottom view)



## REFERENCE DATA

### 1. Max. switching power

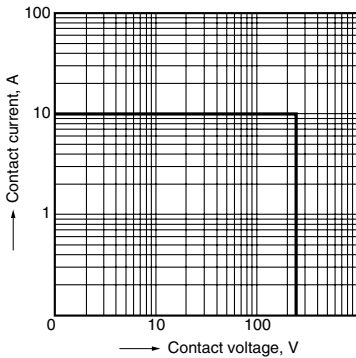

### 2. Coil temperature rise

Sample: LKP1aF-12V, 6 pcs.  
 Point measured: coil inside  
 Contact current: 5 A, 10 A

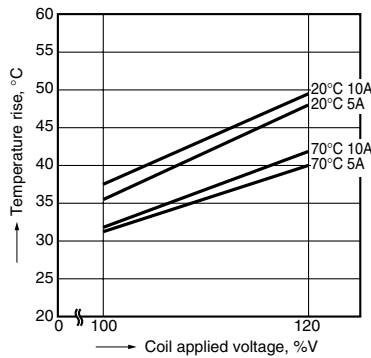

### 3. Ambient temperature characteristics and coil applied voltage

Contact current: 10 A

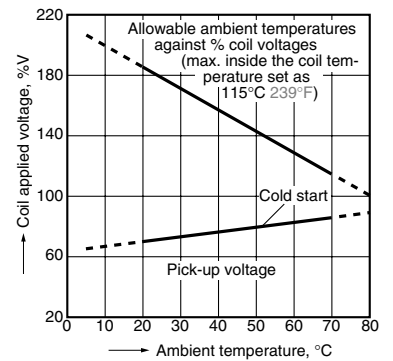

### 4. Life curve

Operation frequency: 20 times/min.  
 (ON/OFF = 1.5s: 1.5s)  
 Ambient temperature: room temperature

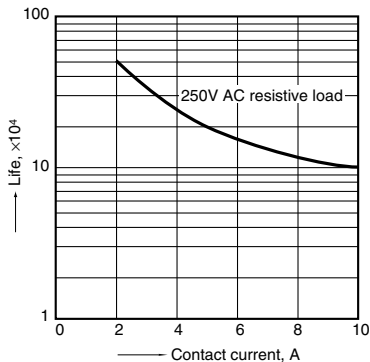

# LK-P

## 5. Electrical life test

(10 A 277 V AC, resistive load)

Sample: LKP1aF-12V, 6 pcs.

Operation frequency: 20 times/min.

(ON/OFF = 1.5s: 1.5s)

Ambient temperature: 20°C 68°F

Circuit:

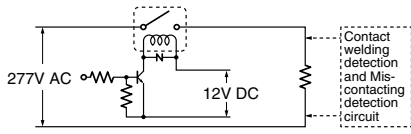

Change of pick-up and drop-out voltage

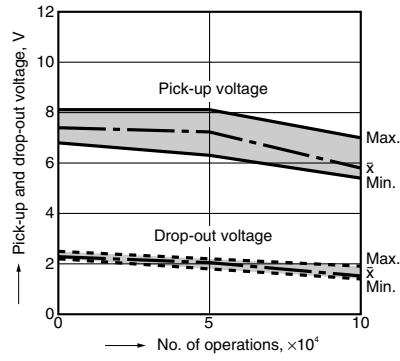

Change of contact resistance

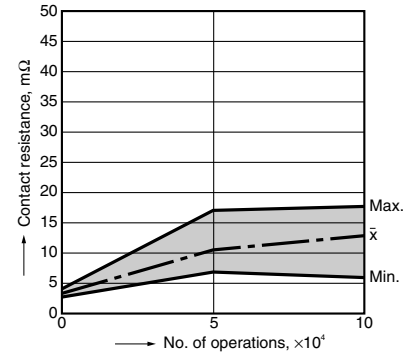

**For Cautions for Use, see Relay Technical Information .**