

8-bit bus interface latch with set and reset (3-State)

74ABT845

FEATURES

- High speed parallel latches
- Ideal where high speed, light loading, or increased fan-in are required with MOS microprocessors
- Broadside pinout
- Output capability: +64mA/-32mA
- Power-up 3-State
- Power-up reset
- Latch-up protection exceeds 500mA per Jedec Std 17
- ESD protection exceeds 2000 V per MIL STD 883 Method 3015 and 200 V per Machine Model

DESCRIPTION

The 74ABT845 consists of eight D-type latches with 3-State outputs. In addition to the LE, OE, MR and PRE pins, the 74ABT845 has two additional OE pins, making a total of three Output Enable (OE0, OE1, OE2) pins. The multiple Output enables allow multiuser control of the interface, e.g., CS, DMA, and RD/WR.

QUICK REFERENCE DATA

SYMBOL	PARAMETER	CONDITIONS $T_{amb} = 25^{\circ}\text{C}; \text{GND} = 0\text{V}$	TYPICAL	UNIT
t_{PLH} t_{PHL}	Propagation delay Dn to Qn	$C_L = 50\text{pF}; V_{CC} = 5\text{V}$	5.4	ns
C_{IN}	Input capacitance	$V_I = 0\text{V}$ or V_{CC}	4	pF
C_{OUT}	Output capacitance	Outputs disabled; $V_O = 0\text{V}$ or V_{CC}	7	pF
I_{CCZ}	Total supply current	Outputs disabled; $V_{CC} = 5.5\text{V}$	500	nA

ORDERING INFORMATION

PACKAGES	TEMPERATURE RANGE	OUTSIDE NORTH AMERICA	NORTH AMERICA	DWG NUMBER
24-Pin Plastic DIP	-40°C to +85°C	74ABT845 N	74ABT845 N	SOT222-1
24-Pin plastic SO	-40°C to +85°C	74ABT845 D	74ABT845 D	SOT137-1
24-Pin Plastic SSOP Type II	-40°C to +85°C	74ABT845 DB	74ABT845 DB	SOT340-1
24-Pin Plastic TSSOP Type I	-40°C to +85°C	74ABT845 PW	74ABT845PW DH	SOT355-1

PIN CONFIGURATION

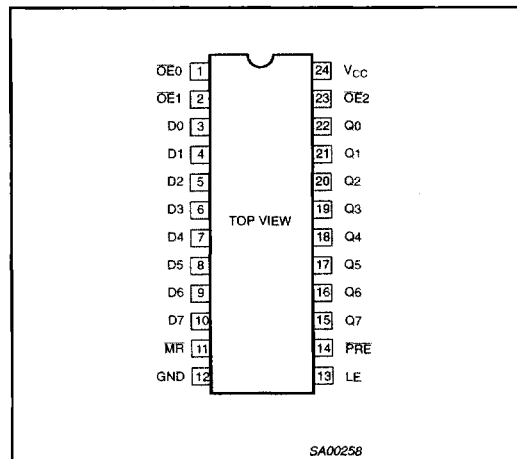

PIN DESCRIPTION

PIN NUMBER	SYMBOL	FUNCTION
1, 2, 23	OE0 - OE2	Output enable inputs (active-Low)
3, 4, 5, 6, 7, 8, 9, 10	D0-D7	Data inputs
22, 21, 20, 19, 18, 17, 16, 15	Q0-Q7	Data outputs
11	MR	Master reset input (active-Low)
13	LE	Latch enable input (active-High)
14	PRE	Preset input (active-Low)
12	GND	Ground (0V)
24	V _{CC}	Positive supply voltage

8-bit bus interface latch with set and reset (3-State)

74ABT845

LOGIC SYMBOL (IEEE/EC)

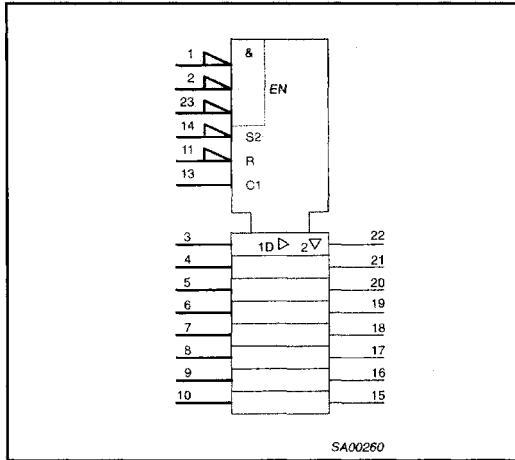

LOGIC SYMBOL

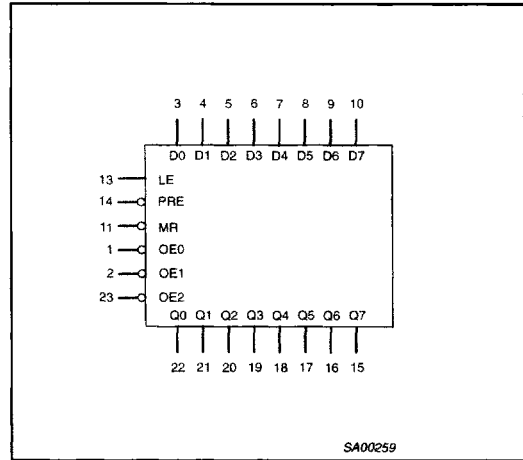

FUNCTION TABLE

INPUTS					OUTPUTS	OPERATING MODE
OE _n	PRE	MR	LE	D _n	Q _n	
L	L	X	X	X	H	Preset
L	H	L	X	X	L	Clear
L	H	H	H	L	L	Transparent
L	H	H	H	H	H	
L	H	H	↓	l	L	Latched
L	H	H	↓	h	H	
H	X	X	X	X	Z	High impedance
L	H	H	L	X	NC	Hold

H = High voltage level
 h = High voltage level one set-up time prior to the High-to-Low LE transition
 L = Low voltage level
 l = Low voltage level one set-up time prior to the High-to-Low LE transition
 NC= No change
 X = Don't care
 Z = High impedance "off" state
 ↓ = High-to-Low transition

LOGIC DIAGRAM

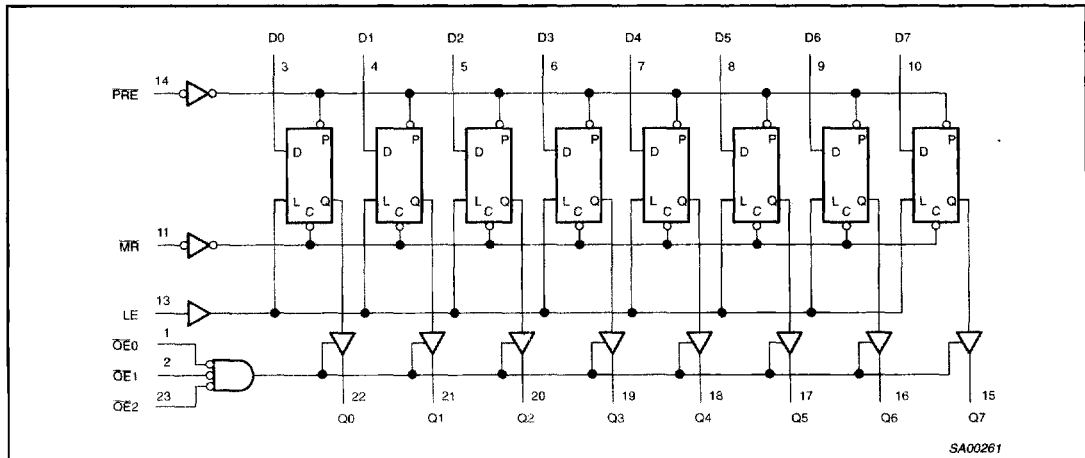

8-bit bus interface latch with set and reset (3-State)

74ABT845

ABSOLUTE MAXIMUM RATINGS^{1,2}

SYMBOL	PARAMETER	CONDITIONS	RATING	UNIT
V_{CC}	DC supply voltage		-0.5 to +7.0	V
I_{IK}	DC input diode current	$V_I < 0$	-18	mA
V_I	DC input voltage ³		-1.2 to +7.0	V
I_{OK}	DC output diode current	$V_O < 0$	-50	mA
V_{OUT}	DC output voltage ³	output in Off or High state	-0.5 to +5.5	V
I_{OUT}	DC output current	output in Low state	128	mA
T_{stg}	Storage temperature range		-65 to 150	°C

NOTES:

- Stresses beyond those listed may cause permanent damage to the device. These are stress ratings only and functional operation of the device at these or any other conditions beyond those indicated under "recommended operating conditions" is not implied. Exposure to absolute-maximum-rated conditions for extended periods may affect device reliability.
- The performance capability of a high-performance integrated circuit in conjunction with its thermal environment can create junction temperatures which are detrimental to reliability. The maximum junction temperature of this integrated circuit should not exceed 150°C.
- The input and output voltage ratings may be exceeded if the input and output current ratings are observed.

RECOMMENDED OPERATING CONDITIONS

SYMBOL	PARAMETER	LIMITS		UNIT
		Min	Max	
V_{CC}	DC supply voltage	4.5	5.5	V
V_I	Input voltage	0	V_{CC}	V
V_{IH}	High-level input voltage	2.0		V
V_{IL}	Low-level input voltage		0.8	V
I_{OH}	High-level output current		-32	mA
I_{OL}	Low-level output current		64	mA
$\Delta t/\Delta v$	Input transition rise or fall rate	0	5	ns/V
T_{amb}	Operating free-air temperature range	-40	+85	°C

8-bit bus interface latch with set and reset (3-State)

74ABT845

DC ELECTRICAL CHARACTERISTICS

SYMBOL	PARAMETER	TEST CONDITIONS	LIMITS					UNIT
			T _{amb} = +25°C			T _{amb} = -40°C to +85°C		
			Min	Typ	Max	Min	Max	
V _{IK}	Input clamp voltage	V _{CC} = 4.5V; I _{IK} = -18mA		-0.9	-1.2		-1.2	V
V _{OH}	High-level output voltage	V _{CC} = 4.5V; I _{OH} = -3mA; V _I = V _{IL} or V _{IH}	2.5	2.9		2.5		V
		V _{CC} = 5.0V; I _{OH} = -3mA; V _I = V _{IL} or V _{IH}	3.0	3.4		3.0		V
		V _{CC} = 4.5V; I _{OH} = -32mA; V _I = V _{IL} or V _{IH}	2.0	2.4		2.0		V
V _{OL}	Low-level output voltage	V _{CC} = 4.5V; I _{OL} = 64mA; V _I = V _{IL} or V _{IH}		0.42	0.55		0.55	V
V _{RST}	Power-up output low voltage ³	V _{CC} = 5.5V; I _O = 1mA; V _I = GND or V _{CC}		0.13	0.55		0.55	V
I _I	Input leakage current	V _{CC} = 5.5V; V _I = GND or 5.5V		±0.01	±1.0		±1.0	µA
I _{OFF}	Power-off leakage current	V _{CC} = 0.0V; V _O or V _I ≤ 4.5V		±5.0	±100		±100	µA
I _{PU/PD}	Power-up/down 3-state output current ⁴	V _{CC} = 2.1V; V _O = 0.5V; V _{OE} = V _{CC} ; V _I = GND or V _{CC}		±5.0	±50		±50	µA
I _{OZH}	3-State output High current	V _{CC} = 5.5V; V _O = 2.7V; V _I = V _{IL} or V _{IH}		5.0	50		50	µA
I _{OZL}	3-State output Low current	V _{CC} = 5.5V; V _O = 0.5V; V _I = V _{IL} or V _{IH}		-5.0	-50		-50	µA
I _{CEX}	Output High leakage current	V _{CC} = 5.5V; V _O = 5.5V; V _I = GND or V _{CC}		5.0	50		50	µA
I _O	Output current ¹	V _{CC} = 5.5V; V _O = 2.5V	-50	-80	-180	-50	-180	mA
I _{OCH}	Quiescent supply current	V _{CC} = 5.5V; Outputs High, V _I = GND or V _{CC}		0.5	250		250	µA
I _{CCL}		V _{CC} = 5.5V; Outputs Low, V _I = GND or V _{CC}		24	30		30	mA
I _{CCZ}		V _{CC} = 5.5V; Outputs 3-State; V _I = GND or V _{CC}		0.5	250		250	µA
ΔI _{CC}	Additional supply current per input pin ²	V _{CC} = 5.5V; one input at 3.4V, other inputs at V _{CC} or GND		0.5	1.5		1.5	mA

NOTES:

- Not more than one output should be tested at a time, and the duration of the test should not exceed one second.
- This is the increase in supply current for each input at 3.4V.
- For valid test results, data must not be loaded into the flip-flops (or latches) after applying the power.
- This parameter is valid for any V_{CC} between 0V and 2.1V with a transition time of up to 10msec. For V_{CC} = 2.1V to V_{CC} = 5V ± 10%, a transition time of up to 100µsec is permitted.

8-bit bus interface latch with set and reset (3-State)

74ABT845

AC CHARACTERISTICS

GND = 0V, $t_R = t_F = 2.5\text{ns}$, $C_L = 50\text{pF}$, $R_L = 500\Omega$

SYMBOL	PARAMETER	WAVEFORM	LIMITS					UNIT
			$T_{\text{amb}} = +25^\circ\text{C}$ $V_{\text{CC}} = +5.0\text{V}$			$T_{\text{amb}} = -40 \text{ to } +85^\circ\text{C}$ $V_{\text{CC}} = +5.0\text{V} \pm 0.5\text{V}$		
			Min	Typ	Max	Min	Max	
t_{PLH} t_{PHL}	Propagation delay Dn to Qn	1	1.0 2.2	3.9 5.4	5.4 6.8	1.0 2.2	6.2 7.8	ns
t_{PLH} t_{PHL}	Propagation delay LE to Qn	2	2.0 2.8	5.1 6.4	6.6 7.9	2.0 2.8	7.5 8.9	ns
t_{PLH} t_{PHL}	Propagation delay PRE to Qn	1	2.2 3.0	4.9 5.3	6.6 6.8	2.2 3.0	7.8 7.4	ns
t_{PLH} t_{PHL}	Propagation delay MR to Qn	1	2.4 3.1	4.9 5.9	6.4 7.3	2.4 3.1	7.3 8.5	ns
t_{PZH} t_{PZL}	Output enable time OEn to Qn	4 5	1.0 2.0	3.8 4.7	5.4 6.1	1.0 2.0	6.3 6.7	ns
t_{PHZ} t_{PLZ}	Output disable time OEn to Qn	4 5	1.9 2.2	4.6 4.7	6.2 6.4	1.9 2.2	7.2 7.0	ns

AC SETUP REQUIREMENTS

GND = 0V, $t_R = t_F = 2.5\text{ns}$, $C_L = 50\text{pF}$, $R_L = 500\Omega$

SYMBOL	PARAMETER	WAVEFORM	LIMITS			UNIT
			$T_{\text{amb}} = +25^\circ\text{C}$ $V_{\text{CC}} = +5.0\text{V}$		$T_{\text{amb}} = -40 \text{ to } +85^\circ\text{C}$ $V_{\text{CC}} = +5.0\text{V} \pm 0.5\text{V}$	
			Min	Typ	Min	
$t_s(\text{H})$ $t_s(\text{L})$	Setup time, High or Low Dn to LE	3	2.8 3.5	1.0 1.4	2.8 3.5	ns
$t_h(\text{H})$ $t_h(\text{L})$	Hold time, High or Low Dn to LE	3	1.0 1.0	-1.2 -0.6	1.0 1.0	ns
$t_w(\text{H})$	LE pulse width, High	3	3.0	1.5	3.0	ns
$t_w(\text{L})$	PRE pulse width, Low	6	3.5	2.0	3.5	ns
$t_w(\text{L})$	MR pulse width, Low	6	2.8	1.3	2.8	ns
t_{rec}	PRE recovery time	6	3.0	1.4	3.0	ns
t_{rec}	MR recovery time	6	3.4	1.6	3.4	ns

8-bit bus interface latch with set and reset (3-State)

74ABT845

AC WAVEFORMS

NOTE: For all waveforms, $V_M = 1.5V$.

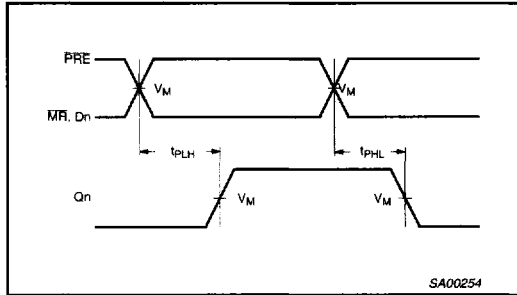

Waveform 1. Propagation Delay, Data to Output, Preset to Output, and Master Reset to Output

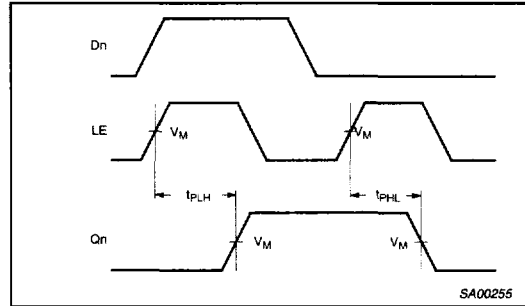

Waveform 2. Propagation Delay, Latch Enable to Output

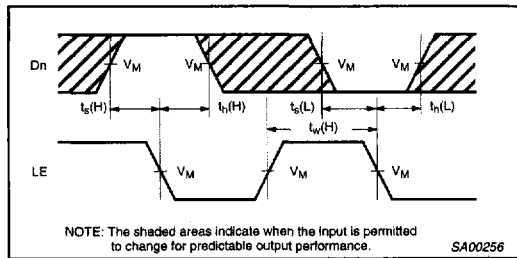

Waveform 3. Data Setup and Hold Times and Latch Enable Pulse Width

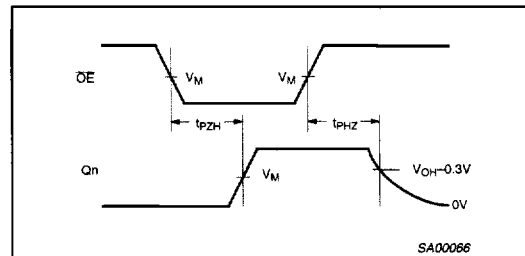

Waveform 4. 3-State Output Enable Time to High Level and Output Disable Time from High Level

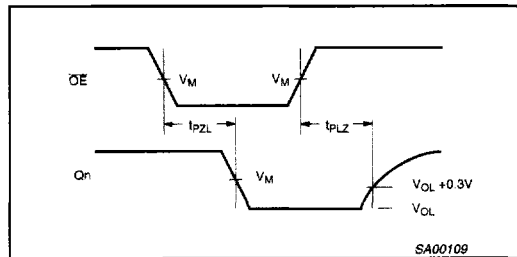

Waveform 5. 3-State Output Enable Time to Low Level and Output Disable Time from Low Level

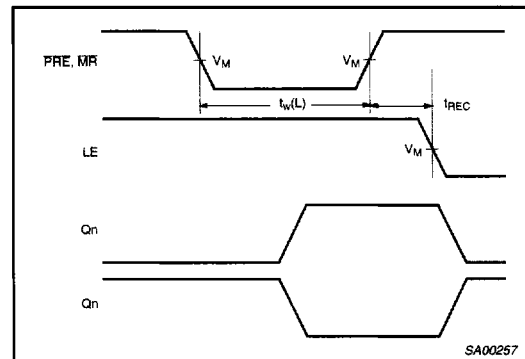

Waveform 6. Master Reset and Preset Pulse Width and Master Reset and Preset to Latch Enable Recovery Time

8-bit bus interface latch with set and reset (3-State)

74ABT845

TEST CIRCUIT AND WAVEFORM

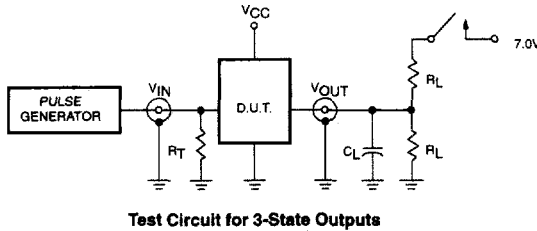

Test Circuit for 3-State Outputs

SWITCH POSITION

TEST	SWITCH
t_{PLZ}	closed
t_{PZL}	closed
All other	open

DEFINITIONS

- R_L = Load resistor; see AC CHARACTERISTICS for value.
- C_L = Load capacitance includes jig and probe capacitance; see AC CHARACTERISTICS for value.
- R_T = Termination resistance should be equal to Z_{OUT} of pulse generators.

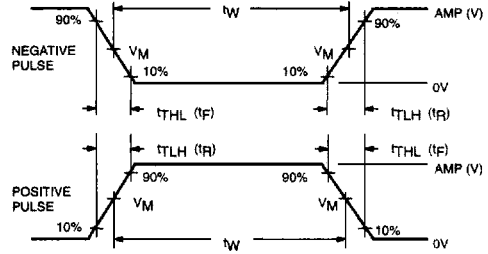

$V_M = 1.5V$

Input Pulse Definition

FAMILY	INPUT PULSE REQUIREMENTS				
	Amplitude	Rep. Rate	t_W	t_R	t_F
74ABT	3.0V	1MHz	500ns	2.5ns	2.5ns

SA00012