



## **SAW Components**

### **SAW Rx 2in1 filter**

GSM 1900 / GSM 850

<b>Series/type:</b>	<b>B9506</b>
<b>Ordering code:</b>	<b>B39202B9506L310</b>
<b>Date:</b>	<b>October 31, 2008</b>
<b>Version:</b>	<b>2.0</b>



Data sheet



Application

- Low-loss 2in1 RF filter for mobile telephone GSM 1900 and GSM 850 systems, receive path (Rx)
- Usable passband:  
 Filter 1 (GSM 1900): 60 MHz  
 Filter 2 (GSM 850): 25 MHz
- Unbalanced to balanced operation for both filters
- Impedance transformation from 50 Ω to 150 Ω for both filters
- Low amplitude ripple
- Suitable for GPRS class 1 to 12

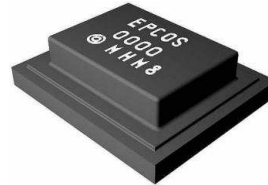

Features

- Package size 1.8 x 1.4 x 0.68 mm<sup>3</sup>
- Package code QCS10U
- RoHS compatible
- Approx. weight 0.006g
- Package for Surface Mount Technology (SMT)
- Ni, gold-plated terminals
- Electrostatic Sensitive Device (ESD)

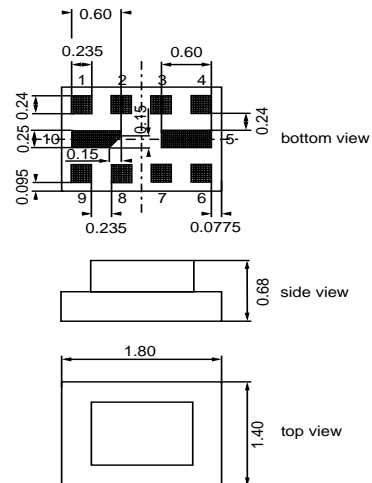

Pin configuration

- 1 Input [Filter 1]
- 4 Input [Filter 2]
- 6,7 Output balanced [Filter 2]
- 8,9 Output balanced [Filter 1]
- 2,3,5,10 Case-ground

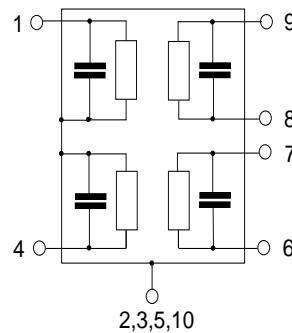



<b>SAW Components</b>	<b>B9506</b>
<b>SAW Rx 2in1 filter</b>	<b>1960.0 / 881.5 MHz</b>

Data sheet



**Characteristics of Filter 1 (GSM1900)**

Temperature range for specification:  $T = -20\text{ °C to }+75\text{ °C}$   
 Terminating source impedance:  $Z_S = 50\ \Omega$   
 Terminating load impedance:  $Z_L = 150\ \Omega \parallel 13\text{ nH (balanced)}$

		min.	typ. @ 25 °C	max.	
<b>Center frequency</b>	$f_C$	—	1960.0	—	MHz
<b>Maximum insertion attenuation</b>	$\alpha_{\max}$	—	1.3	2.3 <sup>1)</sup>	dB
1930.0 ... 1990.0 MHz					
<b>Amplitude ripple (p-p)</b>	$\Delta\alpha$	—	0.4	1.4 <sup>2)</sup>	dB
1930.0 ... 1990.0 MHz					
<b>Input VSWR</b>		—	1.7	2.1	
1930.0 ... 1990.0 MHz					
<b>Output VSWR</b>		—	1.7	2.1	
1930.0 ... 1990.0 MHz					
<b>Output amplitude balance (<math> S_{31}/S_{21} </math>)</b>		-1.3	-0.8/0.2	1.3	dB
1930.0 ... 1990.0 MHz					
<b>Output phase balance (<math>\phi(S_{31})-\phi(S_{21})+180^\circ</math>)</b>		-10	-7/+5	10	°
1930.0 ... 1990.0 MHz					
<b>Attenuation</b>	$\alpha$				
10.0 ... 1510.0 MHz		40	44	—	dB
1510.0 ... 1830.0 MHz		30	34	—	dB
1830.0 ... 1890.0 MHz		20	25	—	dB
1890.0 ... 1910.0 MHz		12	16	—	dB
2010.0 ... 2070.0 MHz		12	17	—	dB
2070.0 ... 2400.0 MHz		19	23	—	dB
2400.0 ... 2500.0 MHz		35	40	—	dB
2500.0 ... 3860.0 MHz		28	33	—	dB
3860.0 ... 3980.0 MHz		36	43	—	dB
3980.0 ... 5790.0 MHz		30	39	—	dB
5790.0 ... 6000.0 MHz		32	40	—	dB

1) 2.2 dB at 25 °C  
 2) 1.3 dB at 25 °C



<b>SAW Components</b>	<b>B9506</b>
<b>SAW Rx 2in1 filter</b>	<b>1960.0 / 881.5 MHz</b>
Data sheet	<b>SMD</b>

**Maximum ratings of Filter 1**

Operable temperature range	T	-40/+85	°C	
Storage temperature range	T <sub>stg</sub>	-40/+85	°C	
DC voltage	V <sub>DC</sub>	5	V	
ESD voltage	V <sub>ESD</sub>	50 <sup>1)</sup>	V	machine model, 1 pulse
Input Power at				
GSM 850, GSM 900	P <sub>IN</sub>	15	dBm	effective power in the on-state, duty cycle 4:8
GSM 1800, GSM 1900	P <sub>IN</sub>	15	dBm	
Tx bands				

<sup>1)</sup> acc. to JESD22-A115A (machine model), 1 negative & 1 positive pulse.



SAW Components

B9506

SAW Rx 2in1 filter

1960.0 / 881.5 MHz

Data sheet



**Transfer function Filter 1 (GSM1900)**

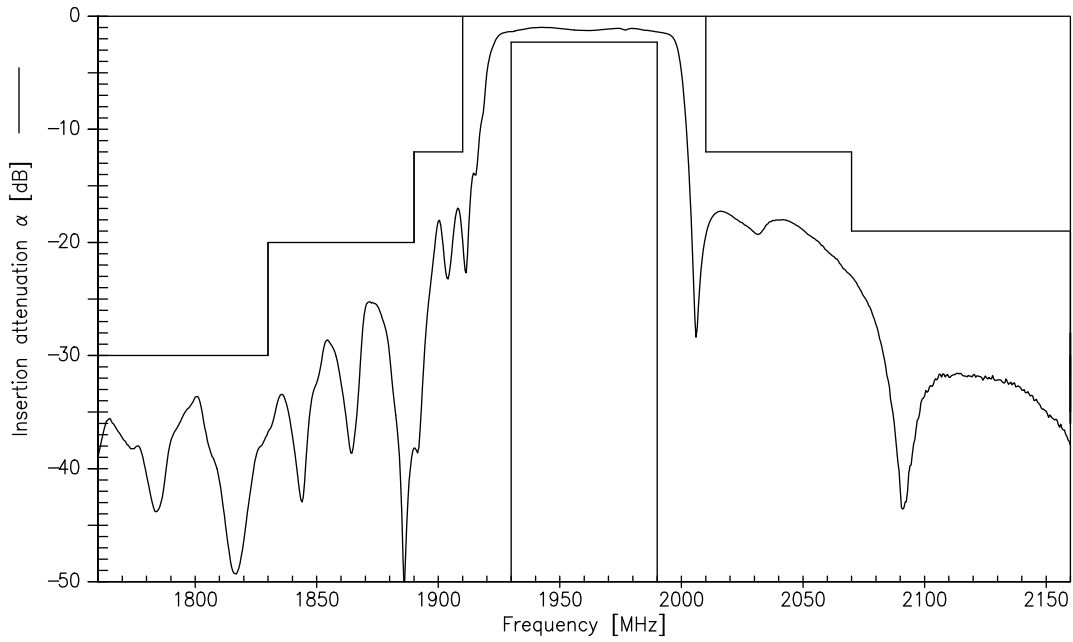

**Transfer function Filter 1 (GSM1900) - Wideband**

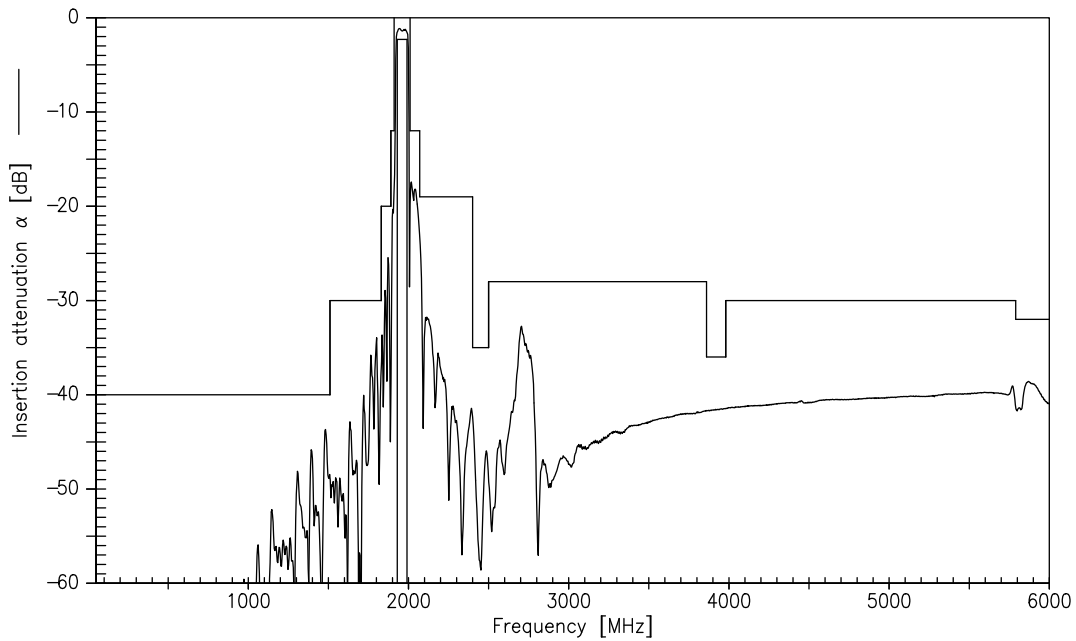

Please read *cautions and warnings* and *important notes* at the end of this document.

Data sheet

**SMD**

Smith charts of Filter 1 (GSM1900)

**S<sub>11</sub> function**

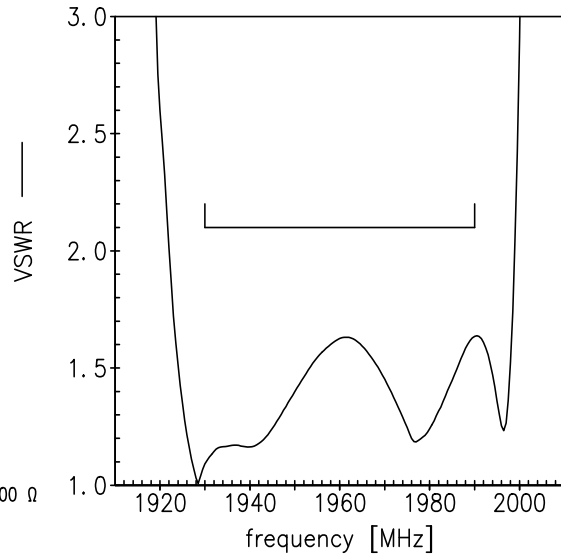
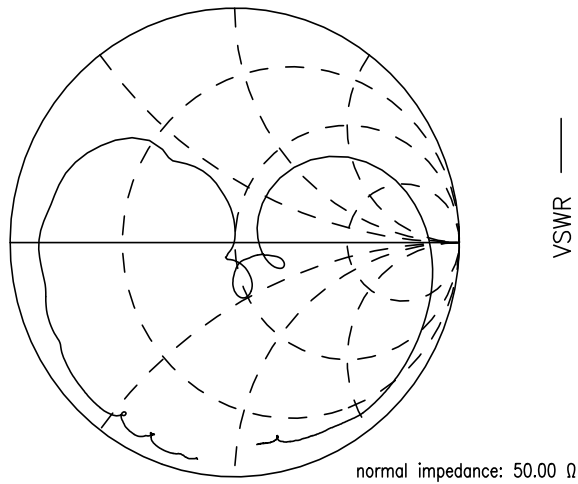

**S<sub>22</sub> function**

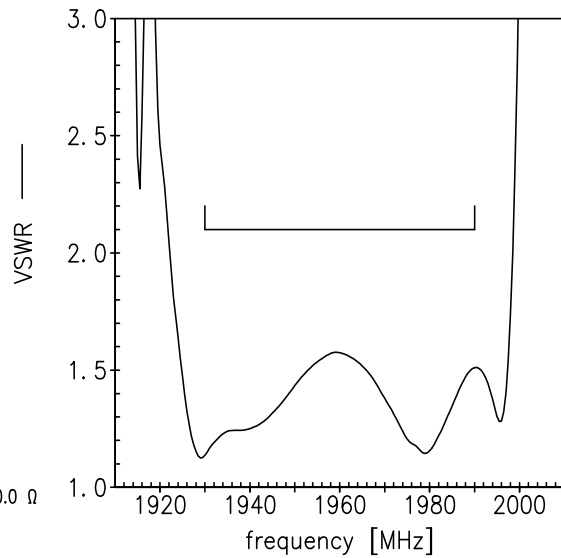
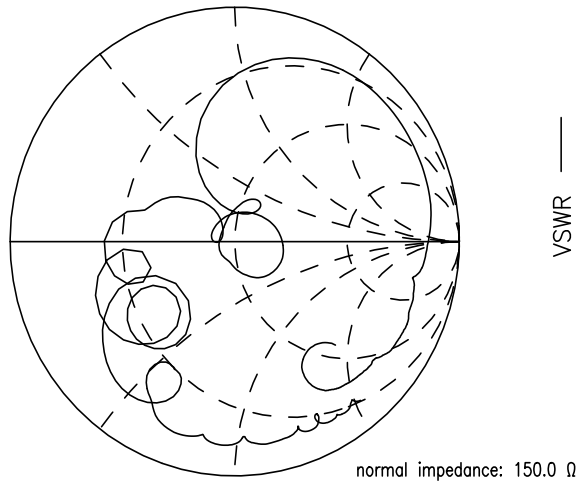



Data sheet



Characteristics of Filter 2 (GSM850)

Temperature range for specification:  $T = -20\text{ °C to }+75\text{ °C}$   
 Terminating source impedance:  $Z_S = 50\ \Omega$   
 Terminating load impedance:  $Z_L = 150\ \Omega \parallel 82\text{ nH (balanced)}$

		min.	typ. @ 25 °C	max.	
<b>Center frequency</b>	$f_C$	—	881.5	—	MHz
<b>Maximum insertion attenuation</b>	$\alpha_{\max}$	—	1.4	2.0 <sup>1)</sup>	dB
869.0 ... 894.0 MHz					
<b>Amplitude ripple (p-p)</b>	$\Delta\alpha$	—	0.5	1.2 <sup>2)</sup>	dB
869.0 ... 894.0 MHz					
<b>Input VSWR</b>		—	1.6	2.0	
869.0 ... 894.0 MHz					
<b>Output VSWR</b>		—	1.6	2.0	
869.0 ... 894.0 MHz					
<b>Output amplitude balance (<math> S_{31}/S_{21} </math>)</b>		-1.2	-1.0/+1.0	1.2	dB
869.0 ... 894.0 MHz					
<b>Output phase balance (<math>\phi(S_{31})-\phi(S_{21})+180^\circ</math>)</b>		-12	-7/+7	12	°
869.0 ... 894.0 MHz					
<b>Attenuation</b>	$\alpha$				
10.0 ... 447.0 MHz		45	49	—	dB
447.0 ... 849.0 MHz		30	37	—	dB
914.0 ... 954.0 MHz		21	26	—	dB
954.0 ... 1738.0 MHz		28	36	—	dB
1738.0 ... 1788.0 MHz		40	56	—	dB
1788.0 ... 3476.0 MHz		35	43	—	dB
3476.0 ... 6000.0 MHz		26	30	—	dB

1) 1.7 dB at 25 °C

2) 0.9 dB at 25 °C



SAW Components

B9506

SAW Rx 2in1 filter

1960.0 / 881.5 MHz

Data sheet

**SMD**

### Maximum ratings of Filter 2

Operable temperature range	T	-40/+85	°C	
Storage temperature range	T <sub>stg</sub>	-40/+85	°C	
DC voltage	V <sub>DC</sub>	5	V	
ESD voltage	V <sub>ESD</sub>	100 <sup>1)</sup>	V	machine model, 1 pulse
Input Power at				
GSM 850, GSM 900	P <sub>IN</sub>	15	dBm	effective power in the on-state, duty cycle 4:8
GSM 1800, GSM 1900	P <sub>IN</sub>	15	dBm	
Tx bands				

<sup>1)</sup> acc. to JESD22-A115A (machine model), 1 negative & 1 positive pulse.





Transfer function Filter 2 (GSM850)

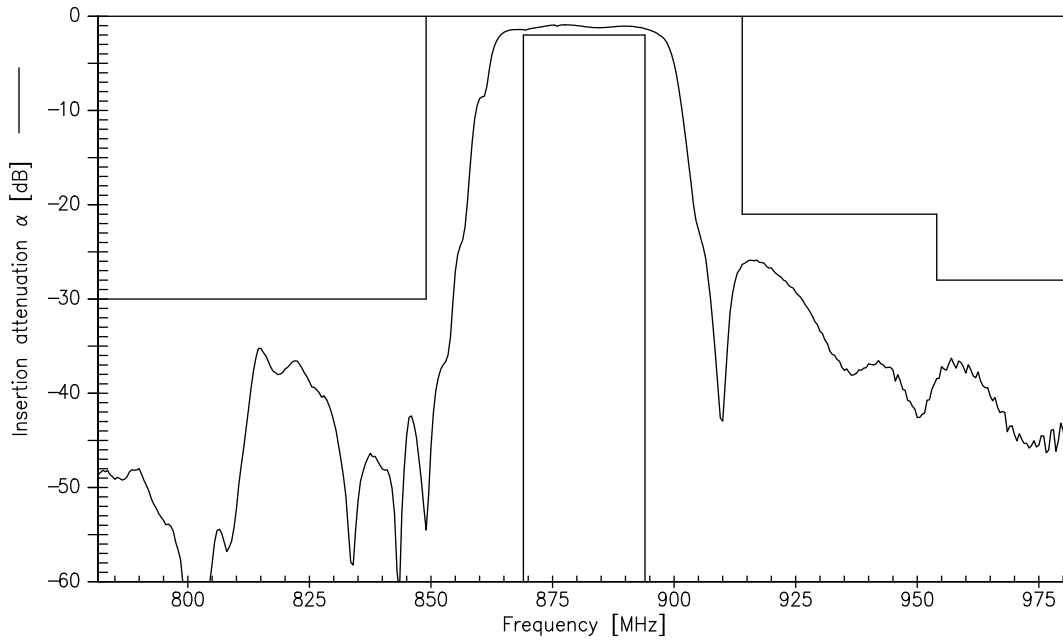

Transfer function Filter 2 (GSM850) - Wideband

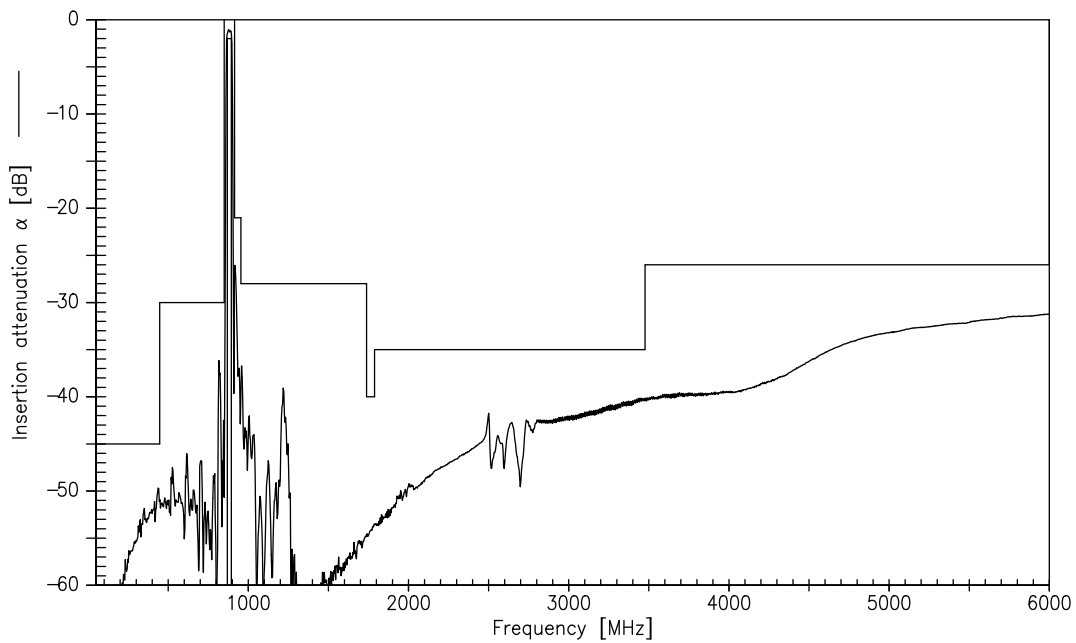

Please read *cautions and warnings* and *important notes* at the end of this document.

Data sheet

**SMD**

Smith charts of Filter 2 (GSM850)

**S<sub>11</sub> function**

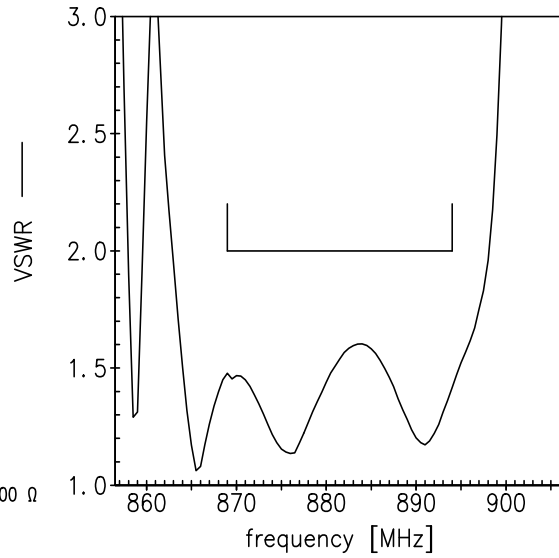
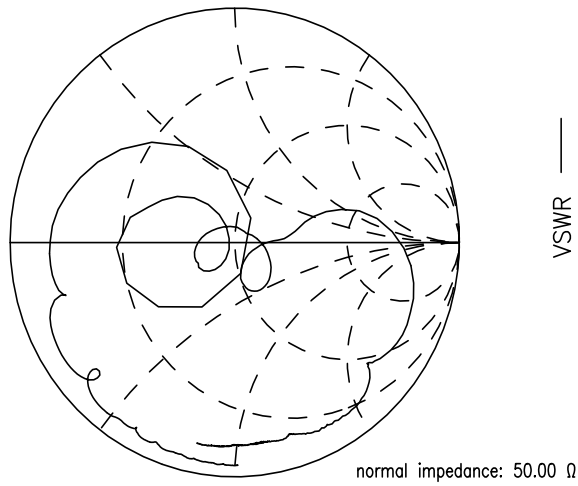

**S<sub>22</sub> function**

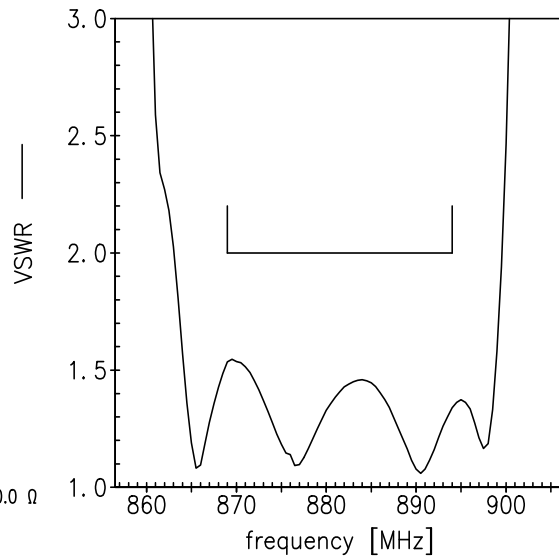
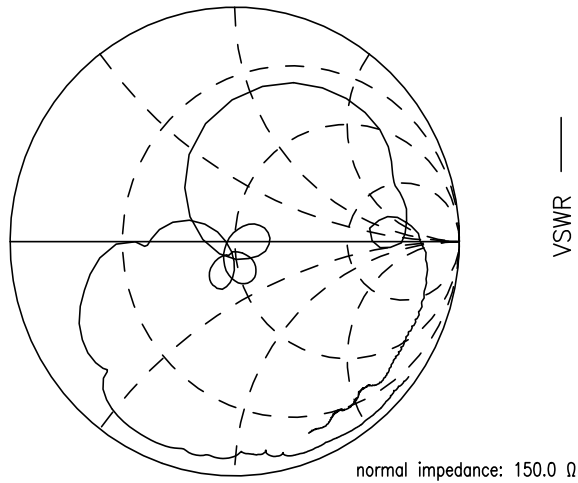



SAW Components

B9506

SAW Rx 2in1 filter

1960.0 / 881.5 MHz

Data sheet



## References

Type	B9506
Ordering code	B39202B9506L310
Marking and package	C61157-A7-A152
Packaging	F61074-V8226-Z000
Date codes	L_1126
S-parameters	B9506_LB_NB.s3p B9506_LB_WB.s3p B9506_UB_NB.s3p B9506_UB_WB.s3p See file header for port/pin assignment table.
Soldering profile	S_6001
RoHS compatible	defined as compatible with the following documents: "DIRECTIVE 2002/95/EC OF THE EUROPEAN PARLIAMENT AND OF THE COUNCIL of 27 January 2003 on the restriction of the use of certain hazardous substances in electrical and electronic equipment. 2005/618/EC from April 18th, 2005, amending Directive 2002/95/EC of the European Parliament and of the Council for the purposes of establishing the maximum concentration values for certain hazardous substances in electrical and electronic equipment."

For further information please contact your local EPCOS sales office or visit our webpage at [www.epcos.com](http://www.epcos.com).

Published by EPCOS AG  
Surface Acoustic Wave Components Division  
P.O. Box 80 17 09, 81617 Munich, GERMANY

© EPCOS AG 2008. This brochure replaces the previous edition.

For questions on technology, prices and delivery please contact the Sales Offices of EPCOS AG or the international Representatives.

Due to technical requirements components may contain dangerous substances. For information on the type in question please also contact one of our Sales Offices.

Please read *cautions and warnings and important notes* at the end of this document.



## Important notes

The following applies to all products named in this publication:

1. Some parts of this publication contain **statements about the suitability of our products for certain areas of application**. These statements are based on our knowledge of typical requirements that are often placed on our products in the areas of application concerned. We nevertheless expressly point out **that such statements cannot be regarded as binding statements about the suitability of our products for a particular customer application**. As a rule, EPCOS is either unfamiliar with individual customer applications or less familiar with them than the customers themselves. For these reasons, it is always ultimately incumbent on the customer to check and decide whether an EPCOS product with the properties described in the product specification is suitable for use in a particular customer application.
2. We also point out that **in individual cases, a malfunction of electronic components or failure before the end of their usual service life cannot be completely ruled out in the current state of the art, even if they are operated as specified**. In customer applications requiring a very high level of operational safety and especially in customer applications in which the malfunction or failure of an electronic component could endanger human life or health (e.g. in accident prevention or life-saving systems), it must therefore be ensured by means of suitable design of the customer application or other action taken by the customer (e.g. installation of protective circuitry or redundancy) that no injury or damage is sustained by third parties in the event of malfunction or failure of an electronic component.
3. **The warnings, cautions and product-specific notes must be observed.**
4. In order to satisfy certain technical requirements, **some of the products described in this publication may contain substances subject to restrictions in certain jurisdictions (e.g. because they are classed as hazardous)**. Useful information on this will be found in our Material Data Sheets on the Internet ([www.epcos.com/material](http://www.epcos.com/material)). Should you have any more detailed questions, please contact our sales offices.
5. We constantly strive to improve our products. Consequently, **the products described in this publication may change from time to time**. The same is true of the corresponding product specifications. Please check therefore to what extent product descriptions and specifications contained in this publication are still applicable before or when you place an order. We also **reserve the right to discontinue production and delivery of products**. Consequently, we cannot guarantee that all products named in this publication will always be available. The aforementioned does not apply in the case of individual agreements deviating from the foregoing for customer-specific products.
6. Unless otherwise agreed in individual contracts, **all orders are subject to the current version of the "General Terms of Delivery for Products and Services in the Electrical Industry" published by the German Electrical and Electronics Industry Association (ZVEI)**.
7. The trade names EPCOS, BAOKE, Alu-X, CeraDiode, CSSP, CTVS, DSSP, MiniBlue, MKK, MLSC, MotorCap, PCC, PhaseCap, PhaseMod, SIFERRIT, SIFI, SIKOREL, SilverCap, SIM-DAD, SIMID, SineFormer, SIOV, SIP5D, SIP5K, ThermoFuse, WindCap are **trademarks registered or pending** in Europe and in other countries. Further information will be found on the Internet at [www.epcos.com/trademarks](http://www.epcos.com/trademarks).