

Dual IGBTMOD™ Compact IGBT Series Module 300 Amperes/1200 Volts

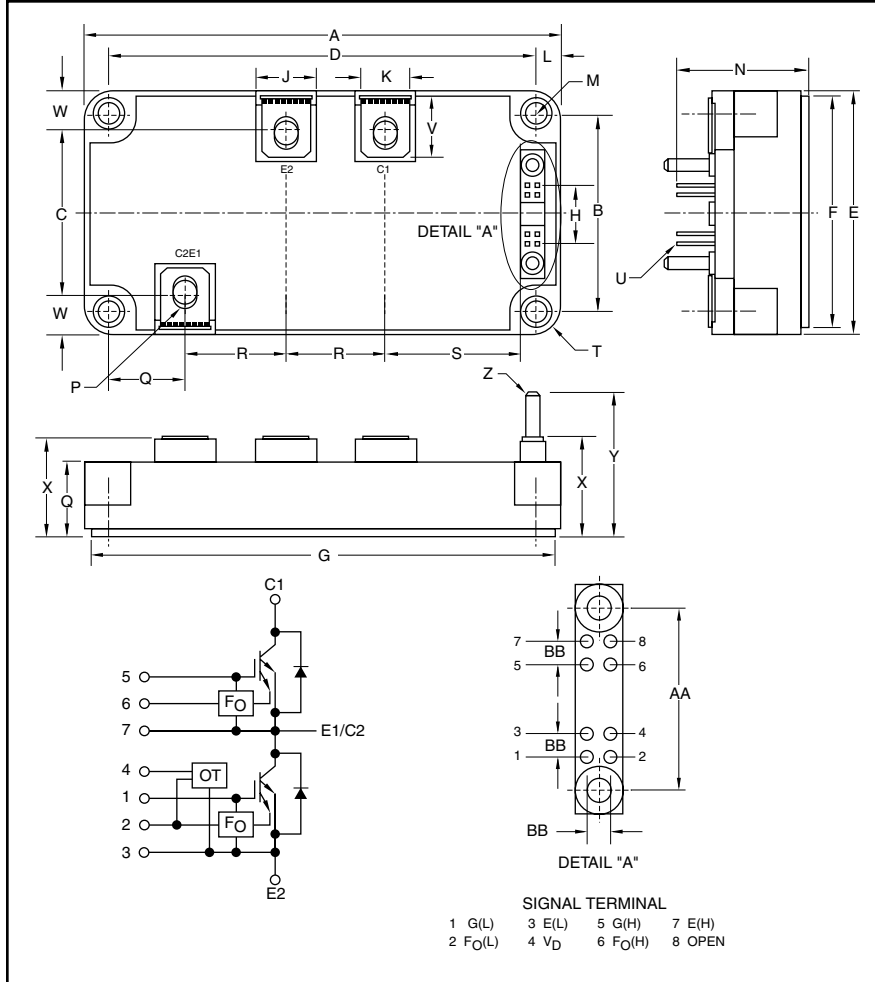

Description:

Powerex Dual IGBTMOD™ Compact IGBT Series Modules are designed for use in switching applications. Each module consists of two IGBT Transistors in a half-bridge configuration, with each transistor having a reverse-connected super-fast recovery free-wheel diode. All components and interconnects are isolated from the heat sinking baseplate, offering simplified system assembly and thermal management.

Features:

- Over-Current and Over-Temperature Protection
- Low $V_{CE(sat)}$
- Isolated Baseplate for Easy Heat Sinking

Applications:

- AC Motor Control
- Motion/Servo Control
- UPS
- Welding Power Supplies
- Laser Power Supplies

Ordering Information:

Example: Select the complete part number from the table below -i.e. MG300Q2YS60A is a 1200V (V_{CES}), 300 Ampere Dual IGBTMOD™ Compact IGBT Series Module.

Type	Current Rating Amperes	V_{CES} Volts (x 20)
MG	300	60

Outline Drawing and Circuit Diagram

Dimensions	Inches	Millimeters
A	4.80±0.04	122.0±1.0
B	1.97±0.01	50.0±0.3
C	1.61 ±0.03	41.0±0.8
D	4.33±0.01	110.0±0.3
E	2.44±0.04	62.0±1.0
F	2.32±0.02	59.0±0.5
G	4.69±0.02	119.0±0.5
H	0.60	15.24
J	0.63	16.0
K	0.51	13.0
L	0.24	6.0
M	0.22 Dia.	5.5 Dia.
N	1.42±0.03	36.0±0.8

Dimensions	Inches	Millimeters
P	M6	M6
Q	0.79±0.03	20.0±0.8
R	1.02±0.03	26.0±0.8
S	1.44±0.03	36.7±0.8
T	0.24 Rad.	6.0 Rad.
U	0.02	0.64
V	0.60	15.3
W	0.41±0.03	10.5±0.8
X	1.02 -0.01/+0.04	26.0-0.3/+1.0
Y	1.48 -0.02/+0.04	37.5-0.5/+1.0
Z	0.01 Dia.	3.0 Dia.
AA	1.00±0.023	25.4±0.6
BB	0.10	2.54



Powerex, Inc., 200 E. Hillis Street, Youngwood, Pennsylvania 15697-1800 (724) 925-7272

MG300Q2YS60A
Dual IGBTMOD™
Compact IGBT Series Module
 300 Amperes/1200 Volts

Absolute Maximum Ratings, $T_j = 25^\circ\text{C}$ unless otherwise specified

Characteristics	Symbol	MG300Q2YS60A	Units
Power Device Junction Temperature	T_j	-20 to 150	$^\circ\text{C}$
Storage Temperature	T_{stg}	-40 to 125	$^\circ\text{C}$
Operating Temperature Range	T_{ope}	-20 ~ 100	$^\circ\text{C}$
Mounting Torque, M5 Mounting Screws	—	31	in-lb
Mounting Torque, M6 Main Terminal Screws	—	40	in-lb
Module Weight (Typical)	—	375	Grams
Isolation Voltage, AC 1 minute, 60Hz Sinusoidal	V_{ISO}	2500	Volts

IGBT Inverter Sector

Collector-Emitter Voltage	V_{CES}	1200	Volts
Gate-Emitter Voltage	V_{GES}	± 20	Volts
Collector Current ($T_C = 25^\circ\text{C}$)	I_C	300	Amperes
Peak Collector Current ($T_C = 25^\circ\text{C}$)	I_{CP}	600	Amperes
Emitter Current ($T_C = 25^\circ\text{C}$)	I_E	300	Amperes
Peak Emitter Current ($T_C = 25^\circ\text{C}$)	I_{EM}	600	Amperes
Collector Dissipation ($T_C = 25^\circ\text{C}$)	P_C	2800	Watts

IGBT Control Sector

Control Voltage (OT)	V_D	20	Volts
Fault Input Voltage	V_{FO}	20	Volts
Fault Input Current	I_{FO}	20	mA

Electrical and Mechanical Characteristics, $T_j = 25^\circ\text{C}$ unless otherwise specified

Characteristics	Symbol	Test Conditions	Min.	Typ.	Max.	Units
Gate Leakage Current	I_{GES}	$V_{\text{GE}} = \pm 20\text{V}, V_{\text{CE}} = 0\text{V}$	—	—	-4 / +3	mA
		$V_{\text{GE}} = 10\text{V}, V_{\text{CE}} = 0\text{V}$	—	—	100	nA
Collector-Emitter Cutoff Current	I_{CES}	$V_{\text{CE}} = 1200\text{V}, V_{\text{GE}} = 0\text{V}$	—	—	1.0	mA
Gate-Emitter Cutoff Voltage	$V_{\text{GE(off)}}$	$V_{\text{CE}} = 5\text{V}, I_C = 300\text{mA}$	6.0	7.0	8.0	Volts
Collector-Emitter Saturation Voltage	$V_{\text{CE(sat)}}$	$V_{\text{GE}} = 15\text{V}, I_C = 300\text{A}, T_j = 25^\circ\text{C}$	—	2.4	2.8	Volts
		$V_{\text{GE}} = 15\text{V}, I_C = 300\text{A}, T_j = 125^\circ\text{C}$	—	—	3.2	Volts
Input Capacitance	C_{ies}	$V_{\text{CE}} = 10\text{V}, V_{\text{GE}} = 0\text{V}, f = 1\text{MHz}$	—	21,000	—	pF
Inductive Load	$t_{\text{d(on)}}$		0.1	—	1.0	μs
Switching Times	t_{off}	$V_{\text{CC}} = 600\text{V}, I_C = 300\text{A}, V_{\text{GE}} = \pm 15\text{V}, R_G = 6.8\Omega$	—	—	2.0	μs
			—	—	0.5	μs
Reverse Recovery Time	t_{rr}		—	—	0.5	μs
Emitter-Collector Voltage	V_{EC}	$I_E = 300\text{A}$	—	2.1	2.6	Volts



Powerex, Inc., 200 E. Hillis Street, Youngwood, Pennsylvania 15697-1800 (724) 925-7272

MG300Q2YS60A
Dual IGBTMOD™
Compact IGBT Series Module
300 Amperes/1200 Volts

Electrical and Mechanical Characteristics, $T_j = 25^\circ\text{C}$ unless otherwise specified

Characteristics	Symbol	Test Conditions	Min.	Typ.	Max.	Units
Control Sector						
Fault Output Current	O_C	$V_{GE} = 15\text{V}$	360	—	—	A
Over-Temperature	O_T	—	100	—	125	$^\circ\text{C}$
Fault Output Delay Time	$t_d(\text{Fo})$	$V_{CC} = 600\text{V}, V_{GE} = \pm 15\text{V}$	—	—	8	μs

Thermal Characteristics

Characteristic	Symbol	Condition	Min.	Typ.	Max.	Units
Junction to Case Thermal Resistance	$R_{th(j-c)Q}$	IGBT (Per 1/2 Module)	—	—	0.044	$^\circ\text{C/Watt}$
	$R_{th(j-c)D}$	FWDi (Per 1/2 Module)	—	—	0.068	$^\circ\text{C/Watt}$
Contact Thermal Resistance	$R_{th(c-f)}$	—	—	0.013	—	$^\circ\text{C/Watt}$

Recommended Conditions for Use

Characteristic	Symbol	Condition	Value	Units
Supply Voltage	V_{CC}	Applied across C1-E2 Terminals	≤ 750	Volts
Gate Voltage	V_{GE}	—	14.8 ~ 17	Volts
Gate Resistance	R_G	—	≥ 6.8	Ω
Switching Frequency	f_C	—	0 ~ 20	kHz

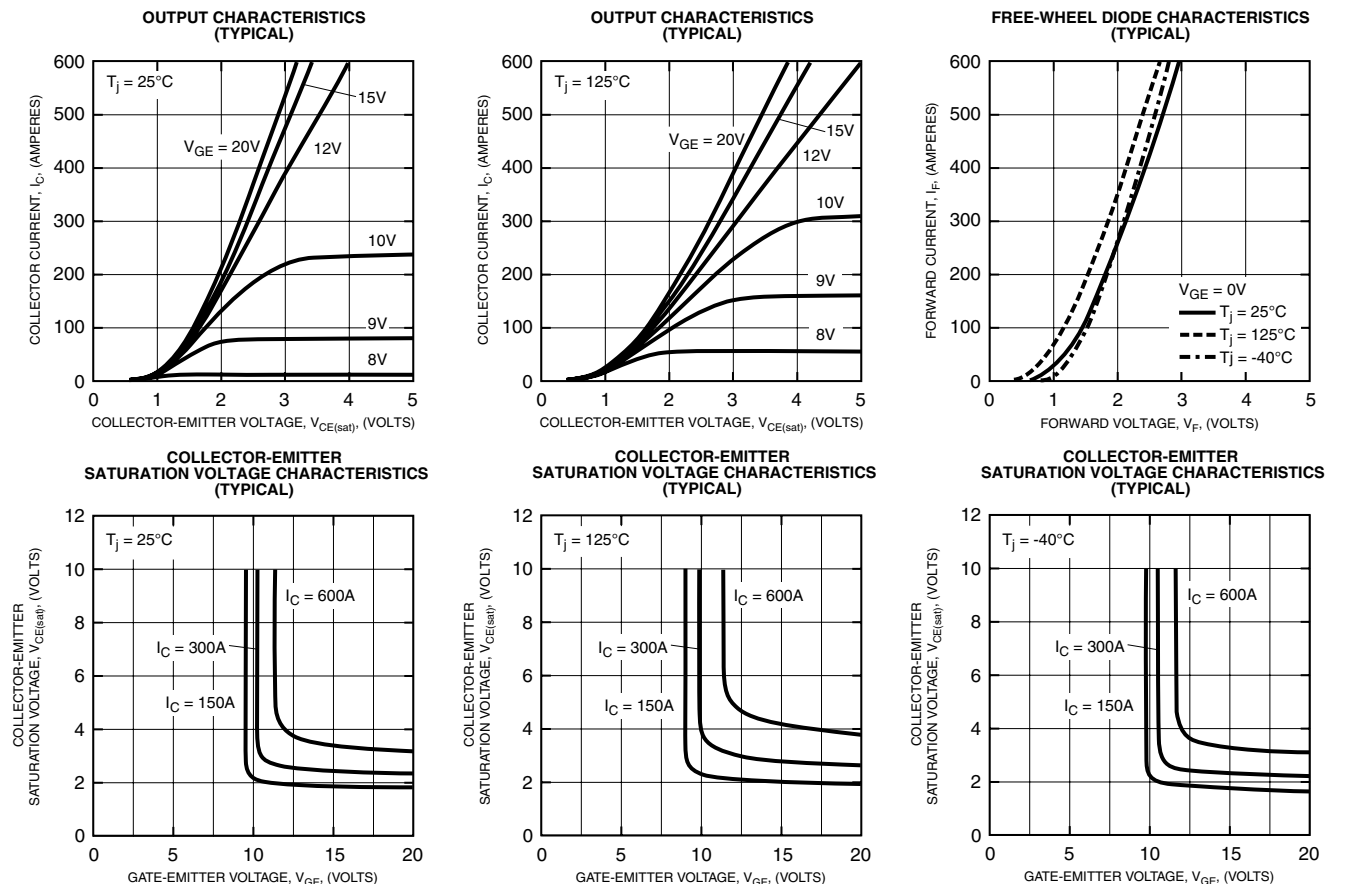



Powerex, Inc., 200 E. Hillis Street, Youngwood, Pennsylvania 15697-1800 (724) 925-7272

MG300Q2YS60A
Dual IGBTMOD™
Compact IGBT Series Module
300 Amperes/1200 Volts

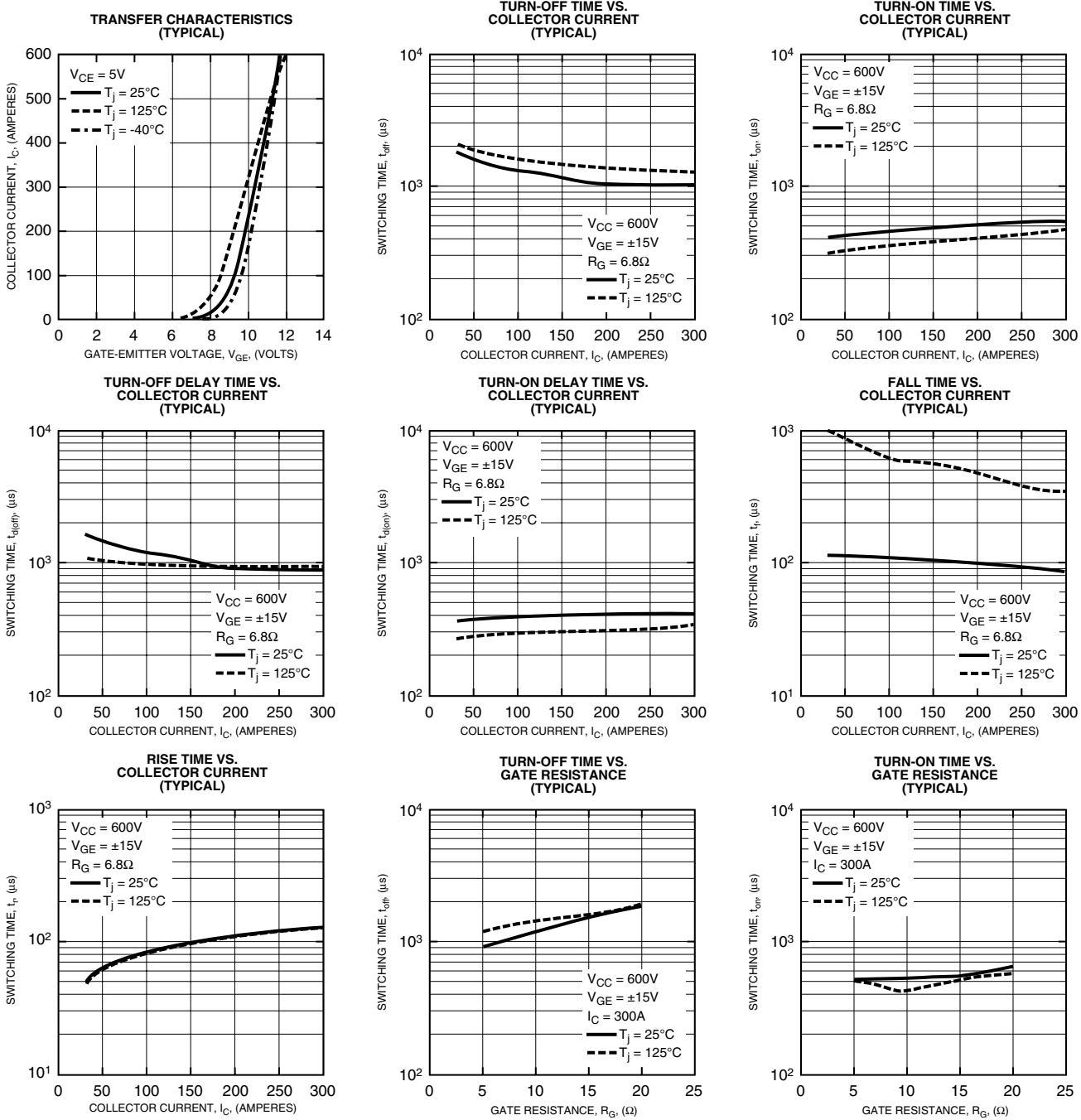

MG300Q2YS60A
Dual IGBTMOD™
Compact IGBT Series Module
 300 Amperes/1200 Volts

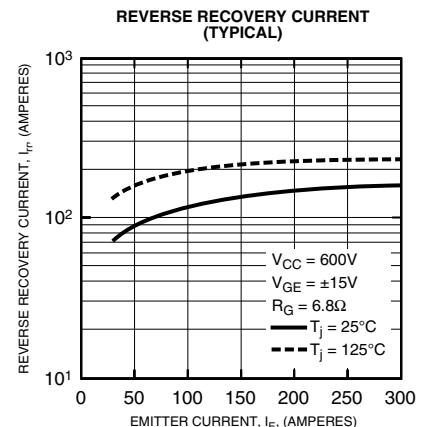
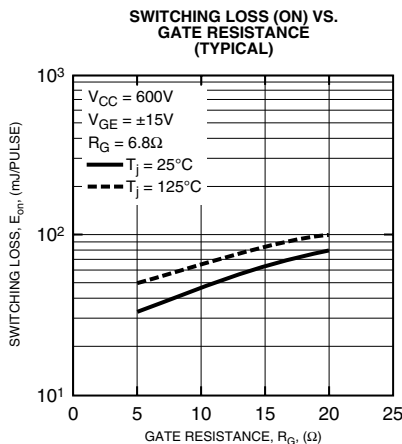
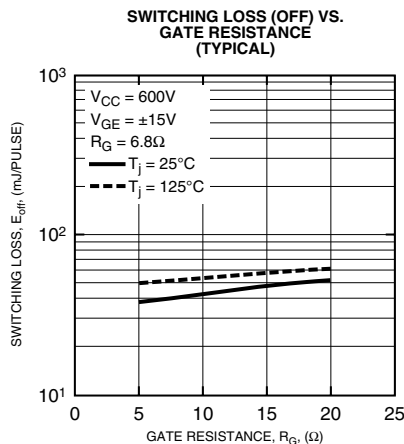
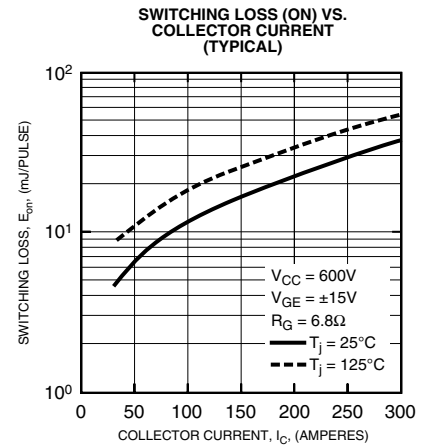
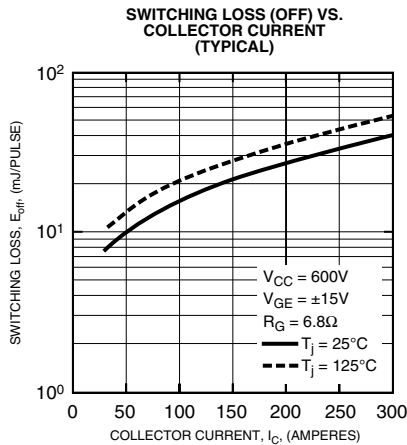
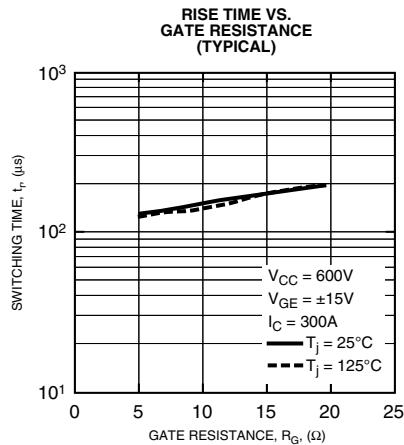
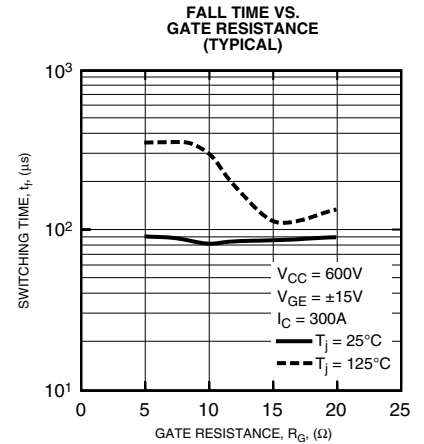
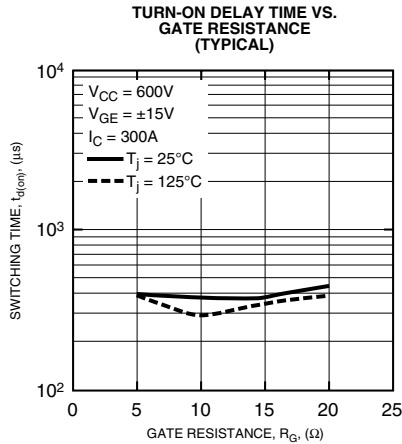
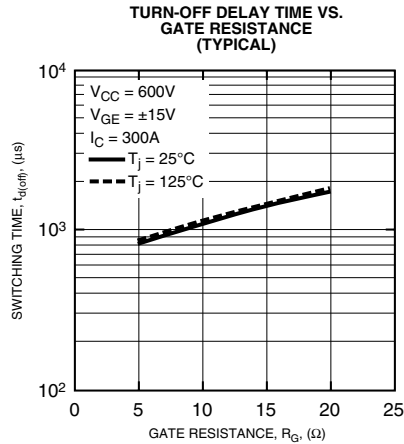



Powerex, Inc., 200 E. Hillis Street, Youngwood, Pennsylvania 15697-1800 (724) 925-7272

MG300Q2YS60A
Dual IGBTMOD™
Compact IGBT Series Module
300 Amperes/1200 Volts

