

[Molex.com](#)

English
日本語
한국어
简体中文

[Register | Login](#)
[My Parts \(0 items \)](#)

Search site:Search: [Go](#)

- Product Name**
- Cross-Ref**
- Catalog**
- Literature**
- Industries**
- Standards**
- Contact Us**
- About Us**
- Investors**
- Careers**

- [Connectors](#)
- [Sockets](#)
- [I/O Connectors](#)
- [Cable Assemblies](#)
- [Fiber Optics](#)
- [Printed Circuit Products](#)
- [Industrial Products](#)
- [Lighting Products](#)

Switch Language

- [Home](#)
- [PCB Headers](#)
- [Datasheet](#)

Need Assistance?

- [Contact Us](#)
- [Find a Distributor](#)
- [Order Samples](#)
- [Tech Library](#)
- [Ecocare](#)
- [Electrical Models](#)

[Printer-friendly page](#)

[Email this page](#)

Part Number:
0430450602

Status:
Active

Overview:
Micro-Fit, 3.0™

Description:
3.00mm (.118") Pitch Micro-Fit 3.0™ Header, Surface Mount Compatible, Dual Row, Right Angle, with Snap-in Plastic Peg PCB Lock, 6 Circuits, 0.76µm (30µ") Gold (Au) Selective Plating, Glow Wire Compatible

Documents: *Note - Please disable browser pop-up blockers for documents on www.molex.com*
[Drawing \(PDF\)](#) [Product Specification PS-43045 \(PDF\)](#)

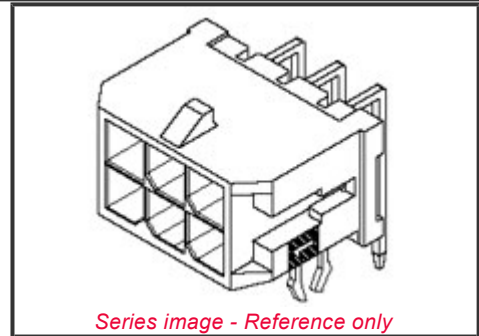

EU RoHS
ELV and RoHS
Compliant

REACH SVHC
Contains SVHC: No

Halogen-Free
Status
Halogen-Free

China RoHS



Need more information on product environmental compliance?Email productcompliance@molex.comFor a multiple part number RoHS Certificate of Compliance, [click here](#)Please visit the [Contact Us](#) section for any non-product compliance questions.**Search Parts in this Series**[43045Series](#)**Mates With**[43025](#)[Product Literature \(PDF\)](#)**Order Products:****Part Detail:** ([show all](#))[General](#)[Physical](#)[Electrical](#)[Agency Certification](#)[Solder Process Data](#)[Material Info](#)[Reference - Drawing Numbers](#)**General**

Product Family	PCB Headers
Series	43045
Application	Wire-to-Board
Comments	Glow Wire Equivalent Part Number 430450602 High Temperature, Square Pin, Solder Type
Overview	Micro-Fit 3.0™
Product Literature Order No	USA-106
Product Name	Micro-Fit 3.0™

Physical

Breakaway	No
Circuits (Loaded)	6
Circuits (maximum)	6
Color - Resin	Black
Durability (mating cycles max)	30
Flammability	94V-0
Glow-Wire Compliant	Yes
Mated Height (in)	0.405 In
Mated Height (mm)	10.29 mm
Material - Metal	Brass
Material - Plating Mating	Gold
Material - Plating Termination	Tin
Material - Resin	High Temperature Thermoplastic
Number of Rows	2
Orientation	Right Angle
PCB Locator	Yes
PCB Retention	Yes
PCB Thickness Recommended (in)	0.062 In
PCB Thickness Recommended (mm)	1.60 mm
Packaging Type	Tray
Pitch - Mating Interface (in)	0.118 In
Pitch - Mating Interface (mm)	3.00 mm
Plating min: Mating (µin)	30
Plating min: Mating (µm)	0.75
Plating min: Termination (µin)	100
Plating min: Termination (µm)	2.5
Polarized to PCB	Yes
Shrouded	Fully
Stackable	No
Surface Mount Compatible (SMC)	Yes
Temperature Range - Operating	-40°C to +105°C
Termination Interface: Style	Through Hole

Electrical(Please review the Product Specification for specific details.)

Current - Maximum per Contact	5A
Voltage - Maximum	250V

Agency Certification

CSA	LR19980
TUV	R72081037
UL	E29179

Solder Process Data

Duration at Max. Process Temperature (seconds)	30
--	----

Lead-free Process Capability	SMC & Wave Capable (TH only)
------------------------------	------------------------------

Max. Cycles at Max. Process Temperature	3
---	---

Process Temperature max. C	260
----------------------------	-----

Material Info**Reference - Drawing Numbers**

Product Specification	PS-43045, RPS-43045-003, RPS-43045-004
-----------------------	--

Sales Drawing	SD-43045-001
---------------	--------------