

## SD-14550 Series Programmable Synchro/Resolver- to-Digital Converters

Make sure the next  
Card you purchase  
has...



### FEATURES

- Synthesized Reference Option
- 1 Minute Accuracy Available ("S" Option only)
- Single +5 V Power Supply
- 10-, 12-, 14-, or 16-Bit Programmable Resolution
- Small 34-Pin Ceramic Package
- $\overline{\text{BIT}}$  Output
- Velocity Output Eliminates Tachometer
- High Reliability Single Chip Monolithic
- -55°C to +125°C Operating Temperature Range
- MIL-PRF-38534 Processing Available

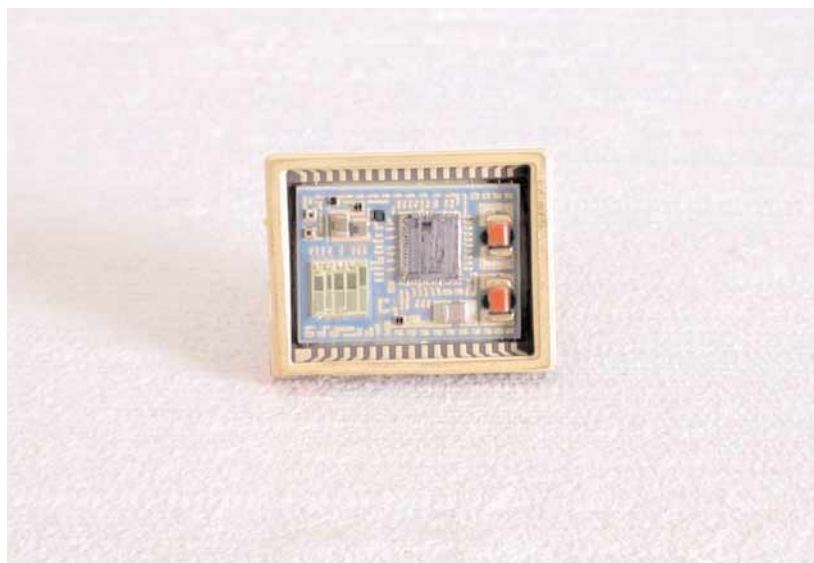

### DESCRIPTION

The SD-14550 Series are small complete low cost hybrid synchro- or resolver-to-digital converters based on a single-chip monolithic. The SD-14550X "S" option offers synthesized reference circuitry to correct for phase shifts between the reference and signal voltage. The completely self-contained unit offers programmable resolution and +5 VDC operation. The package is a 34-pin, 1.0 x 0.78 x 0.21 inch ceramic package.

Resolution programming allows selection of 10-, 12-, 14-, or 16-bit modes. This feature allows selection of either low resolution for fast tracking or higher resolution for higher accuracy.

The velocity output (VEL) from the SD-14550, which can be used to replace a tachometer, is a  $\pm 4$  V signal referenced to analog ground with a linearity of 1% of output voltage.

This converter series also offers a Built-In-Test output ( $\overline{\text{BIT}}$ ). The SD-14550 converters are available with operating temperature ranges of 0°C to +70°C, -40°C to +85°C and -55°C to +125°C. These converters are also available with MIL-PRF-38534 processing.

### APPLICATIONS

With its low cost, small size, high accuracy, and versatile performance, the SD-14550 Series converters are ideal for use in modern high-performance military, commercial and space position control systems. Typical applications include radar antenna positioning, navigation and fire control systems, motor control, and robotics.

FOR MORE INFORMATION CONTACT:

Technical Support:  
1-800-DDC-5757 ext. 7382



Data Device Corporation  
105 Wilbur Place  
Bohemia, New York 11716  
631-567-5600 Fax: 631-567-7358  
[www.ddc-web.com](http://www.ddc-web.com)

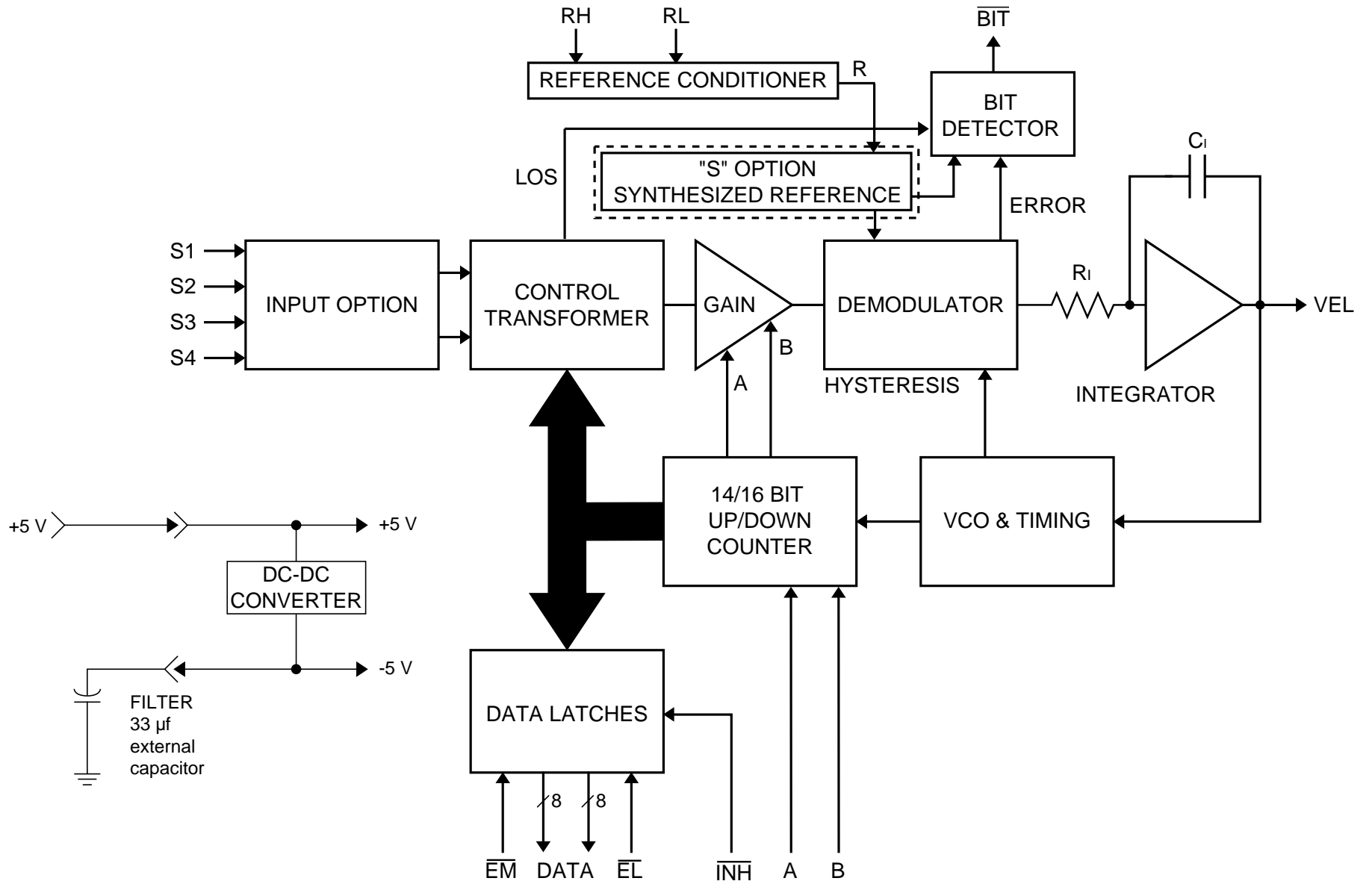

FIGURE 1. SD-14550 SERIES BLOCK DIAGRAM

**TABLE 1. SD-14550 SERIES SPECIFICATIONS**

These specs apply over the rated power supply, temperature, and reference frequency ranges; 10% signal amplitude variation, and 10% harmonic distortion.

| PARAMETER                                     | UNIT  | VALUE  |                            |
|---|-------|--|----------------------------|
| <b>RESOLUTION</b>                             | Bits  | programmable 10, 12, 14, or 16   |                            |
| <b>ACCURACY</b>                               | Min   | 1, 2 or 4, + 1 LSB (see TABLE 4)   |                            |
| <b>REPEATABILITY</b>                          | LSB   | 1 max.   |                            |
| <b>DIFFERENTIAL LINEARITY</b>                 | LSB   | 1 max.   |                            |
| <b>REFERENCE INPUT</b><br>Type                |       | (RH, RL)<br>differential   |                            |
| <b>SD-14550</b>                               |       | <b>2 &amp; 11.8 V UNITS</b>  | <b>90 V UNIT</b>           |
| Voltage Range                                 | Vrms  | 2-35   | 10-130                     |
| Frequency                                     | Hz    | 360 - 5K   | 60 (47-5K)<br>400 (360-5K) |
| Input Impedance<br>single ended               | Ohm   | 60K  | 270K min.                  |
| differential                                  | Ohm   | 120K   | 540K min.                  |
| Common-Mode Range                             | Vpeak | 50,<br>100 transient   | 200,<br>300 transient      |
| <b>SD-14550XS</b>                             |       |  |                            |
| Voltage Range                                 | Vrms  | 2-35   | —                          |
| Frequency                                     | Hz    | 1K - 5K  | —                          |
| Input Impedance<br>single ended               | Ohm   | 40K  | —                          |
| differential                                  | Ohm   | 80K  | —                          |
| Common-Mode Range                             | Vpeak | 50,<br>100 transient   | —                          |
| ±Sig/Ref Phase Shift                          | deg.  | 45 max.  | —                          |
| <b>SIGNAL INPUT CHARACTERISTICS</b>           |       |  |                            |
| 90 V Synchro Input (L-L)                      |       |  |                            |
| Zin line-to-line                              | Ohm   | 123K   |                            |
| Zin line-to-ground                            | Ohm   | 80K  |                            |
| Common-Mode Voltage                           | V     | 180 max.   |                            |
| 11.8 V Synchro Input (L-L)                    |       |  |                            |
| Zin line-to-line                              | Ohm   | 52K  |                            |
| Zin line-to-ground                            | Ohm   | 34K  |                            |
| Common-Mode Voltage                           | V     | 30 max.  |                            |
| 11.8 V Resolver Input (L-L)                   |       | (same for "S" option)  |                            |
| Zin line-to-line                              | Ohm   | 140K   |                            |
| Zin line-to-ground                            | Ohm   | 70K  |                            |
| Common-Mode Voltage                           | V     | 30 max.  |                            |
| 2 V Direct Input (L-L)                        |       |  |                            |
| Voltage Range                                 | Vrms  | 2 nom, 2.3 max.  |                            |
| Max. Voltage w/o Damage                       | V     | 25 cont, 100 pk transient  |                            |
| Input Impedance                               | Ohm   | 20 M    10 pF min.   |                            |
| 2 V Resolver Input (L-L)                      |       | ("S" option only)  |                            |
| Zin line-to-line                              | Ohm   | 11K  |                            |
| Zin line-to-ground                            | Ohm   | 22K  |                            |
| Common-Mode Voltage                           | V     | 4.9 max.   |                            |
| <b>DIGITAL INPUT/OUTPUT LOGIC TYPE INPUTS</b> |       | TTL/CMOS compatible<br>Logic 0 = 0.8 V max.<br>Logic 1 = 2.0 V min.<br>Loading = 10 µA max P.U. current source to +5 V    5 pF max.<br>CMOS transient protected. |                            |
| Resolution Control                            |       | See TABLE 2.   |                            |

**TABLE 1. SD-14550 SERIES SPECS. (CONTINUED)**

| PARAMETER  | UNIT    | VALUE  |          |
|--|---------|--|----------|
| <b>DIGITAL INPUT/OUTPUT INPUTS (CONTINUED)</b>   |         |  |          |
| Inhibit ( $\overline{INH}$ )                     |         | Logic 0 inhibits; Data stable within 0.5 µs  |          |
| Enable Bits 1 to 8 ( $\overline{EM}$ )           |         | Logic 0 enables; Data stable within 150 ns   |          |
| Enable Bits 9 to 16 (EL)                         |         | Logic 1 = High Impedance<br>Data High Z within 100 ns  |          |
| <b>OUTPUTS</b>                                   |         |  |          |
| Parallel Data                                    | bits    | 16 parallel lines; 2 bytes natural binary angle, positive logic.   |          |
| Built-In-Test                                    |         | LOGIC 0 = BIT condition.<br>~ ± 100 LSBs of error with a filter of 500 µs for LOS.<br>(LOS and LOR for "S" option) |          |
| Drive Capability                                 | TTL     | 50 PF +<br>Logic 0; 1 TTL load, 1.6 mA at 0.4 V max<br>Logic 1; 10 TTL loads, -0.4 mA at 2.8 V min                 |          |
|  | CMOS    | Logic 0; 100mV max. driving<br>Logic 1; +5 V supply minus 100 mV min.  |          |
| <b>VELOCITY CHARACTERISTICS</b><br>(see Note 1.) |         |  |          |
| Polarity   |         | Positive for increasing angle  |          |
| Voltage Range (Full Scale)                       | ±V      | 4.0 typ.   | 3.5 min. |
| Scale Factor                                     | ±%      | 10 typ.  | 20 max.  |
| Scale Factor TC                                  | ppm/°C  | 100 typ.   | 200 max. |
| Reversal Error                                   | ±%      | 1 typ.   | 2 max.   |
| Linearity  | ±%      | 0.5 typ.   | 1 max.   |
| Zero Offset                                      | mV      | 5 typ.   | 10 max.  |
| Zero Offset TC                                   | µV/°C   | 15 typ.  | 30 max.  |
| Load   | KOhm    |  | 20 max.  |
| Noise  | (Vp/V)% | 1 typ.   | 2 max.   |
| <b>POWER SUPPLIES</b>                            |         |  |          |
| Nominal Voltage                                  | V       | +5   |          |
| Voltage Tolerance                                | %       | ±5   |          |
| Max. Voltage w/o Damage                          | V       | +7   |          |
| Current  | mA      | 30 typ.  | 35 max.  |
| "S" option                                       | mA      | 30 typ.  | 35 max.  |
| <b>TEMPERATURE RANGE</b>                         |         |  |          |
| Operating  |         |  |          |
| -30X   | °C      | 0 to +70   |          |
| -20X   | °C      | -40 to +85   |          |
| -10X   | °C      | -55 to +125  |          |
| Storage  | °C      | -65 to +150  |          |
| <b>PHYSICAL CHARACTERISTICS</b>                  |         |  |          |
| Size   | in (mm) | 1.00 x 0.78 x 0.21<br>(25.4 x 19.81 x 5.33)  |          |
| Weight   | oz (g)  | 0.44<br>(12.47)  |          |

**NOTES:**

1. Refer to TABLE 3 for full-scale tracking rate.

## THEORY OF OPERATION

The SD-14550 Series of converters are based upon a single chip CMOS custom monolithic. They are implemented using the latest IC technology, which merges precision analog circuitry with digital logic to form a complete high performance tracking synchro/resolver-to-digital converter.

## CONVERTER OPERATION

FIGURE 1 is the functional block diagram of the SD-14550 Series. The converter operates with a single +5 V DC power supply and internally generates a negative voltage of approximately 5 volts. This negative voltage comes out on pin 5 (filter point) — see GENERAL SETUP CONSIDERATIONS.

The converter is made up of three main sections; an input front-end, an error processor, and a digital interface. The converter front-end differs for synchro, resolver and direct inputs. An electronic Scott-T is used for synchro inputs, a resolver conditioner for resolver inputs, and a sine and cosine voltage follower for direct inputs. These amplifiers feed the high accuracy Control Transformer (CT). Its other input is the 16-bit digital angle  $\phi$ . Its output is an analog error angle, or difference angle, between the two inputs. The CT performs the ratiometric trigonometric computation of  $\text{SIN}\theta\text{COS}\phi - \text{COS}\theta\text{SIN}\phi = \text{SIN}(\theta - \phi)$  using amplifiers, switches, logic, and capacitors in precision ratios.

The converter accuracy is limited by the precision of the computing elements in the CT. In these converters ratioed capacitors are used in the CT, instead of the more conventional precision ratioed resistors. Capacitors used as computing elements with op-amps need to be sampled to eliminate voltage drifting. Therefore, the circuits are sampled at a high rate to eliminate this drifting and at the same time to cancel out the op-amp offsets.

The error processing is performed using the industry standard technique for type II tracking R/D converters. The DC error is integrated yielding a velocity voltage which in turn drives a voltage controlled oscillator (VCO). This VCO is an incremental integrator (constant voltage input to position rate output) which together with the velocity integrator forms a type II servo feedback loop. A lead in the frequency response is introduced to stabilize the loop and another lag at higher frequency is introduced to reduce the gain and ripple at the carrier frequency and above.

## GENERAL SETUP CONSIDERATIONS

The following recommendations should be considered when using the SD-14550 Series converters:

- 1) The power supply is +5 V DC.
- 2) Direct inputs are referenced to AGND.
- 3) Connect (close to hybrid) pin 31 (Analog Ground) to pin 7 (GND).
- 4) Connect a 33  $\mu\text{F}/10$  VDC tantalum filter capacitor externally between pin 5 (filter point) to pin 7 (ground).

## PROGRAMMABLE RESOLUTION

Resolution is controlled by pins 27 and 28. The resolution can be changed during converter operation so that the appropriate resolution and velocity dynamics can be set as needed. To insure that a race condition does not exist between counting and changing the resolution, the resolution control is latched internally. Refer to TABLE 2 for resolution control.

**TABLE 2. RESOLUTION CONTROL (A AND B)**

| RESOLUTION | B | A |
|------------|---|---|
| 10 bit     | 0 | 0 |
| 12 bit     | 0 | 1 |
| 14 bit     | 1 | 0 |
| 16 bit     | 1 | 1 |

## BIT (BUILT-IN-TEST)

This output is a logic line that will flag an internal fault condition or LOS (Loss-Of-Signal). The internal fault detector monitors the internal loop error and, when it exceeds approximately  $\pm 100$  LSBs, will set the line to a logic 0; this condition will occur during a large-step input and will reset to a logic 1 after the converter settles out. (The error voltage is filtered with a 500  $\mu\text{s}$  filter.)  $\overline{\text{BIT}}$  will set for an over velocity condition because the converter loop cannot maintain input/output sync.  $\overline{\text{BIT}}$  will also be set if a total LOS (loss of all signals) occurs. Additionally, in the SD-14550XS version,  $\overline{\text{BIT}}$  will set when a Loss-of-Reference (LOR) condition occurs.

## NO FALSE 180° HANGUP

This feature eliminates the “false 180° reading” during instantaneous 180° step changes; this condition most often occurs when the input is “electronically switched” from a digital-to-synchro converter. If the “MSB” (or 180° bit) is “toggled” on and off, a converter without the “false 180° hangup” feature may fail to respond.

The condition is artificial, as a “real” synchro or resolver cannot change its output 180° instantaneously. The condition is most often noticed during wraparound verification tests, simulations, or troubleshooting.

## SYNTHESIZED REFERENCE

The synthesized reference section (“S” option) eliminates errors due to phase shift between the reference and signal inputs. Quadrature voltages in a resolver or synchro are by definition the resulting 90° fundamental signal in the nulled out error voltage (e) in the converter. Due to the inductive nature of synchros and resolvers, their output signals lead the reference input signal (RH and RL). When an uncompensated reference signal is used to demodulate the control transformer’s output, quadrature voltages are not completely eliminated. As shown in FIGURE 1, the converter synthesizes its own internal reference signal based on the SIN and COS signal inputs. Therefore, the phase of the synthesized (internal) reference is determined by the signal input, resulting in reduced quadrature errors. The synthesized reference circuit also eliminates the 180 degree false error null hang up.

## INTERFACING

### SOLID-STATE BUFFER PROTECTION - TRANSIENT VOLTAGE SUPPRESSION

The solid-state signal and reference inputs are true differential inputs with high AC and DC common rejection, so most applications will not require units with isolation transformers. Input impedance is maintained with power off. The recurrent AC peak + DC common mode voltage should not exceed the values in TABLE 1.

The 90 V line-to-line systems may have voltage transients which exceed the 300 V specification listed in TABLE 1. **These transients can destroy the thin-film input resistor network in the hybrid.** Therefore, 90 V L-L solid-state input modules may be protected by installing voltage suppressors as shown in FIGURE 2. Voltage transients are likely to occur whenever a synchro is switched on and off. For instance, a 1000 V transient can be generated when the primary of a CX or TX input is opened.

### INHIBIT AND ENABLE TIMING

The Inhibit ( $\overline{INH}$ ) signal is used to freeze the digital output angle in the transparent output data latch while the data is being transferred. Application of an inhibit signal does not interfere with the continuous tracking of the converter. As shown in FIGURE 3, angular output data is valid 500 nanoseconds maximum after the application of the low-going inhibit pulse.

Output angle data is enabled onto the tri-state data bus in 2 bytes. This Enable MSB ( $\overline{EM}$ ) is used for the most significant 8 bits and Enable LSB ( $\overline{EL}$ ) is used for the least significant bits. As

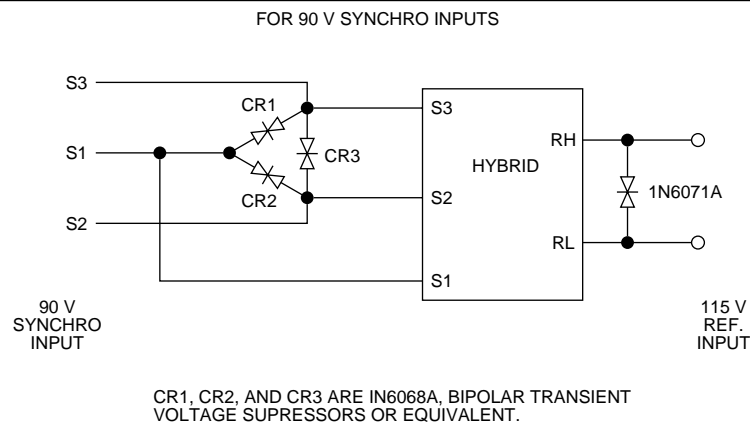

**FIGURE 2. CONNECTIONS FOR VOLTAGE TRANSIENT SUPPRESSORS**

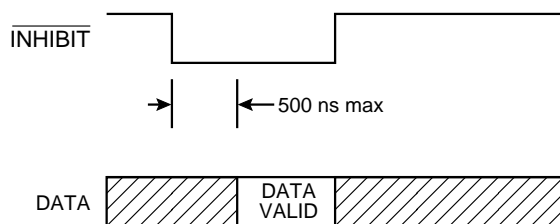

**FIGURE 3. INHIBIT TIMING**

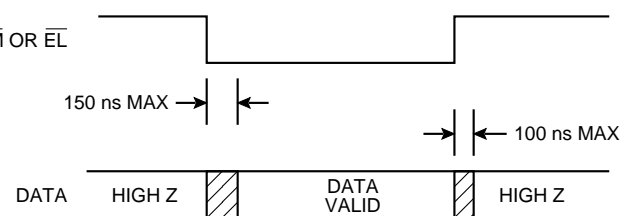

**FIGURE 4. ENABLE TIMING**

**TABLE 3. DYNAMIC CHARACTERISTICS**

| PARAMETER                     | UNITS              | DEVICE TYPE |           |           |           |           |           |           |           |            |           |           |           |
|-------------------------------|--------------------|-------------|-----------|-----------|-----------|-----------|-----------|-----------|-----------|------------|-----------|-----------|-----------|
|                               |                    | 60 Hz       |           |           |           | 400 Hz    |           |           |           | "S" OPTION |           |           |           |
|                               |                    | 10          | 12        | 14        | 16        | 10        | 12        | 14        | 16        | 10         | 12        | 14        | 16        |
| Input Frequency               | Hz                 | 47 - 5K     |           |           |           | 360 - 5K  |           |           |           | 1K - 5K    |           |           |           |
| Bandwidth (Closed Loop)       | Hz                 | 15          |           |           |           | 56        |           |           |           | 150        |           |           |           |
| Ka                            | 1/s <sup>2</sup>   | 830         |           |           |           | 53K       |           |           |           | 110K       |           |           |           |
| A1                            | 1/s                | 0.17        |           |           |           | 0.41      |           |           |           | 2.47       |           |           |           |
| A2                            | 1/s                | 5K          |           |           |           | 41K       |           |           |           | 44.4K      |           |           |           |
| A                             | 1/s                | 29          |           |           |           | 130       |           |           |           | 333        |           |           |           |
| B                             | 1/s                | 14.5        |           |           |           | 81        |           |           |           | 166        |           |           |           |
| <b>RESOLUTION</b>             | <b>BITS</b>        | <b>10</b>   | <b>12</b> | <b>14</b> | <b>16</b> | <b>10</b> | <b>12</b> | <b>14</b> | <b>16</b> | <b>10</b>  | <b>12</b> | <b>14</b> | <b>16</b> |
| Tracking Rate (rps)           |                    |             |           |           |           |           |           |           |           |            |           |           |           |
| typical                       | rps                | 32          | 8         | 2         | 0.5       | 160       | 40        | 10        | 2.5       | 160        | 40        | 10        | 2.5       |
| minimum                       | rps                | 25.6        | 6.4       | 1.6       | 0.4       | 128       | 32        | 8         | 2         | 128        | 32        | 8         | 2         |
| Acceleration ( 1 LSB lag)     | deg/s <sup>2</sup> | 720         | 180       | 45        | 11.3      | 5950      | 1490      | 372       | 93        | 39K        | 9760      | 2440      | 610       |
| Settling Time (179° step max) | msec               | 400         | 500       | 1100      | 2500      | 90        | 100       | 180       | 360       | 51         | 78        | 150       | 232       |

shown in FIGURE 4, output data is valid 150 nanoseconds maximum after the application of a low-going enable pulse. The tri-state data bus returns to the high impedance state 100 nanoseconds maximum after the rising edge of the enable signal.

**DYNAMIC PERFORMANCE**

A type II servo loop (Kv = ∞) and very high acceleration constants give the SD-14550 superior dynamic performance.

*TRANSFER FUNCTION AND BODE PLOT*

The dynamic performance of the converter can be determined from its functional block diagram (FIGURE 1), its transfer function block diagram (FIGURE 5), and its bode plots (open and closed loop - FIGURE 6). Values for the transfer function block can be obtained from TABLE 3.

The open loop transfer function is as follows:

$$\text{Open Loop Transfer Function} = \frac{A^2 \left( \frac{S}{B} + 1 \right)}{S^2 \left( \frac{S}{10B} + 1 \right)}$$

where A is the gain coefficient  
and B is the frequency of lead compensation

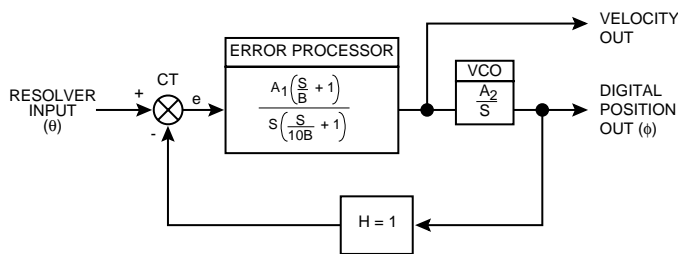

$$\text{Open Loop Transfer Function} = \frac{A^2 \left( \frac{S}{B} + 1 \right)}{S^2 \left( \frac{S}{10B} + 1 \right)} \quad \text{WHERE: } A^2 = A_1 A_2$$

**FIGURE 5. TRANSFER FUNCTION BLOCK DIAGRAM**

*ACCURACY AND RESOLUTION*

TABLE 4 lists the total accuracy including quantitation for the various resolutions and accuracy grades.

**TABLE 4. ACCURACY/RESOLUTION**

| VERSION                  | ACCURACY (minutes)<br>See Note 1 | RESOLUTION VS ACCURACY (In LSB's - See Note 2) |             |             |               |
|--------------------------|----------------------------------|--|-------------|-------------|---------------|
|                          |                                  | 10 BIT   | 12 BIT      | 14 BIT      | 16 BIT        |
| SD-1455X-XX              | 4 +1 LSB<br>2 +1 LSB             | 2<br>2   | 2<br>2      | 4<br>3      | 13<br>7       |
| SD-1455X-XS ("S" option) | 4 +1 LSB<br>2 +1 LSB<br>1 +1 LSB | 2<br>2<br>2                                    | 2<br>2<br>2 | 4<br>3<br>2 | 13<br>7<br>4* |

\* 1.3 minute (4 LSB) accuracy available for "S" option only. Inclusive of 1 bit of jitter.

Note 1: Accuracy Base measured in 16 bit mode.

Note 2: Accuracy in Resolution rounded up to next LSB:

LSB in 16 Bit mode = 0.3 minutes

LSB in 14 Bit mode = 1.3 minutes

LSB in 12 bit mode = 5.3 minutes

LSB in 10 Bit mode = 21.1 minutes

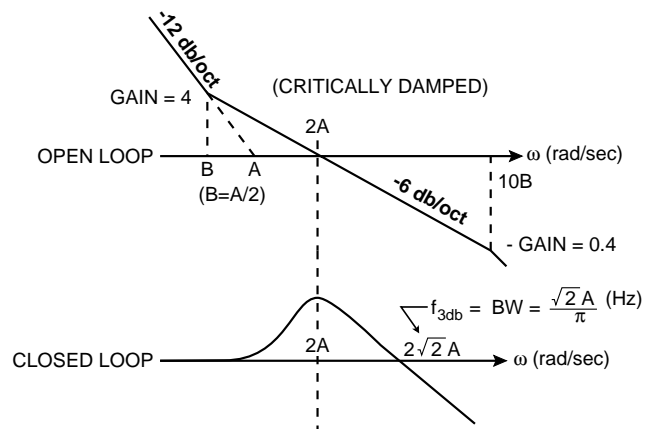
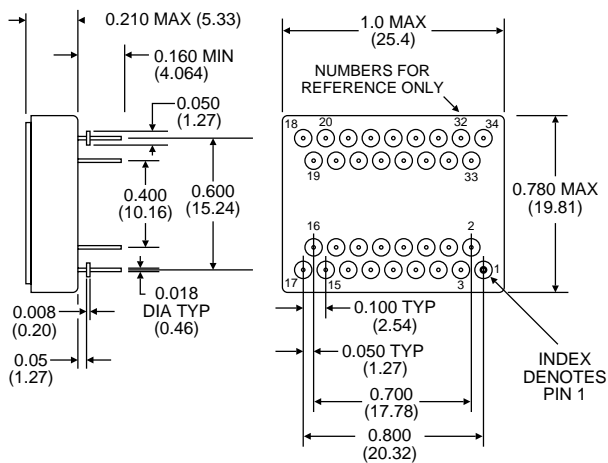

**FIGURE 6. BODE PLOTS**

| TABLE 5. PINOUTS (DIP AND FLAT PACK) |                           |        |         |     |                           |
|--------------------------------------|---------------------------|--------|---------|-----|---------------------------|
| PIN                                  | FUNCTION                  |        |         | PIN | FUNCTION                  |
| 1                                    | S1 (R)                    | S1 (S) | N.C.    | 34  | RH (+Reference input)     |
| 2                                    | S2 (R)                    | S2 (S) | COS (D) | 33  | RL (-Reference input)     |
| 3                                    | S3 (R)                    | S3 (S) | SIN (D) | 32  | N.C.                      |
| 4                                    | S4 (R)                    | N.C.   | N.C.    | 31  | AGND (Analog Ground)      |
| 5                                    | Filter Point              |        |         | 30  | VEL (Velocity Output)     |
| 6                                    | +5 V (Power Supply)       |        |         | 29  | INH (Inhibit)             |
| 7                                    | GND (ground)              |        |         | 28  | B (Resolution Control B)  |
| 8                                    | EM (Enable MSBs)          |        |         | 27  | A (Resolution Control A)  |
| 9                                    | BIT (Built-In-Test)       |        |         | 26  | EL (Enable LSBs)          |
| 10                                   | Bit 1 (MSB)               |        |         | 25  | Bit 16 (LSB, 16-bit mode) |
| 11                                   | Bit 9                     |        |         | 24  | Bit 8                     |
| 12                                   | Bit 2                     |        |         | 23  | Bit 15                    |
| 13                                   | Bit 10 (LSB, 10-bit mode) |        |         | 22  | Bit 7                     |
| 14                                   | Bit 3                     |        |         | 21  | Bit 14 (LSB, 14-bit mode) |
| 15                                   | Bit 11                    |        |         | 20  | Bit 6                     |
| 16                                   | Bit 4                     |        |         | 19  | Bit 13                    |
| 17                                   | Bit 12 (LSB, 12-bit mode) |        |         | 18  | Bit 5                     |

Notes:

- (S) = Synchro; (R) = Resolver; (D) = 2 V Resolver Direct.
- Connect (close to the hybrid) pin 31 to pin 7.
- Connect a 33  $\mu$ F/10 VDC tantalum filter cap from pin 5 to pin 7.



Notes:

- Dimensions are in inches (mm).
- Lead identification numbers are for reference only
- Lead cluster shall be centered within  $\pm 0.005$  (0.13) of outline dimensions.  
Lead spacing dimensions apply only at seating plane.
- Pin material meets solderability requirements to MIL-STD-202E, Method 208C.
- Case is hermetically sealed ceramic package.

**FIGURE 7. SD-14550 MECHANICAL OUTLINE (DIP)**

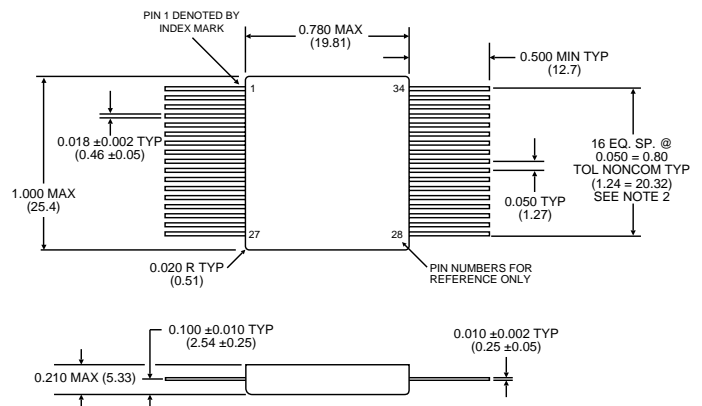

Notes:

- Dimensions are in inches (mm).
- Lead cluster shall be centralized about case centerline within  $\pm 0.010$  ( $\pm 2.54$ ).

**FIGURE 8. SD-14550 MECHANICAL OUTLINE (FLAT PACK)**



## ORDERING INFORMATION

SD-1455X X X - X X X X

### Supplemental Process Requirements:

S = Pre-Cap Source Inspection  
L = Pull Test  
Q = Pull Test and Pre-Cap Inspection  
K = One Lot Date Code  
W = One Lot Date Code and Pre-Cap Source  
Y = One Lot Date Code and 100% Pull Test  
Z = One Lot Date Code, Pre-Cap Source and 100% Pull Test  
Blank = None of the Above

### Accuracy:

2 = 4 min + 1 LSB  
4 = 2 min + 1 LSB  
5 = 1 min + 1 LSB (available with "S" option only)

### Reliability Grade:

0 = Standard DDC Processing, no Burn-In (See table on next page.)  
1 = MIL-PRF-38534 Compliant  
2 = B\*  
3 = MIL-PRF-38534 Compliant with PIND Testing  
4 = MIL-PRF-38534 Compliant with Solder Dip  
5 = MIL-PRF-38534 Compliant with PIND Testing and Solder Dip  
6 = B\* with PIND Testing  
7 = B\* with Solder Dip  
8 = B\* with PIND Testing and Solder Dip  
9 = Standard DDC Processing with Solder Dip, no Burn-In (See table on next page.)

### Temperature Grade/Data Requirements:

1 = -55°C to +125°C  
2 = -40°C to +85°C  
3 = 0°C to +70°C  
4 = -55°C to +125°C + Variables Test Data  
5 = -40°C to +85°C + Variables Test Data  
8 = 0°C to +70°C + Variables Test Data

### Options:

X = None  
S = Synthesized Reference

### Package Type:

D = DIP  
F = Flat Pack

### Input Options:

0 = 11.8 V, Synchro, 400 Hz  
1 = 11.8 V, Resolver, 400 Hz  
2 = 90 V, Synchro, 400 Hz  
3 = 2 V, Direct, 400 Hz  
4 = 90 V, Synchro, 60 Hz

### Input Options ("S" Option):

1 = 11.8 V, Resolver, 1 KHz  
3 = 2 V, Resolver (Differential), 1 KHz

\*Standard DDC Processing with burn-in and full temperature test — see table on next page.



| <b>STANDARD DDC PROCESSING</b> |                            |                     |
|--------------------------------|----------------------------|---------------------|
| <b>TEST</b>                    | <b>MIL-STD-883</b>         |                     |
|                                | <b>METHOD(S)</b>           | <b>CONDITION(S)</b> |
| INSPECTION                     | 2009, 2010, 2017, and 2032 | —                   |
| SEAL                           | 1014                       | A and C             |
| TEMPERATURE CYCLE              | 1010                       | C                   |
| CONSTANT ACCELERATION          | 2001                       | A                   |
| BURN-IN                        | 1015, Table 1              | —                   |

**NOTES:**

**NOTES:**

The information in this data sheet is believed to be accurate; however, no responsibility is assumed by Data Device Corporation for its use, and no license or rights are granted by implication or otherwise in connection therewith.  
Specifications are subject to change without notice.



105 Wilbur Place, Bohemia, New York, U.S.A. 11716-2482

**For Technical Support - 1-800-DDC-5757 ext. 7382**

**Headquarters, N.Y., U.S.A.** - Tel: (631) 567-5600, Fax: (631) 567-7358

**Southeast, U.S.A.** - Tel: (703) 450-7900, Fax: (703) 450-6610

**West Coast, U.S.A.** - Tel: (714) 895-9777, Fax: (714) 895-4988

**United Kingdom** - Tel: +44-(0)1635-811140, Fax: +44-(0)1635-32264

**Ireland** - Tel: +353-21-341065, Fax: +353-21-341568

**France** - Tel: +33-(0)1-41-16-3424, Fax: +33-(0)1-41-16-3425

**Germany** - Tel: +49-(0)8141-349-087, Fax: +49-(0)8141-349-089

**Japan** - Tel: +81-(0)3-3814-7688, Fax: +81-(0)3-3814-7689

**World Wide Web** - <http://www.ddc-web.com>

