

# Am29510/L510

16 X 16 Multiplier Accumulator

## DISTINCTIVE CHARACTERISTICS

- Uses two's complement or unsigned inputs and
- Round control
- Output register preload
- 35-bit product accumulator result
  - 32-bit product
  - 3-bit extended product
- IMOX™ processing
  - ECL internal circuitry for speed
  - TTL I/O, Single 5V Supply
- FAST
  - High speed version multiply accumulate time 80ns
  - Low power version multiply accumulate time 110ns

## GENERAL DESCRIPTION

The Am29510 is a high-speed 16 x 16-bit multiplier/accumulator (MAC). The X and Y input registers accept 16-bit inputs in either two's complement or unsigned magnitude format. A third register stores the Two's Complement (TC), Round (RND), Accumulator (ACC), and Subtraction/Addition (SUB/ADD) control bits. This register is clocked whenever the X or Y input registers are clocked.

The 35-bit accumulator/output register contains the full 32-bit multiplier output which is sign extended or zero-filled based on the TC control bit. The accumulator can also be

preloaded from an external source through the bidirectional P port. The operation of the accumulator is controlled by the signals ACC, (Accumulator), SUB/ADD (Subtraction/Addition), and PREL (Preload). Each of the input registers and the output register has independent clocks.

The Am29L510 is a low-power version of the Am29510. The Am29L510 consumes only one-half the power of its standard power counterpart while maintaining nearly two-thirds the speed.

## BLOCK DIAGRAM

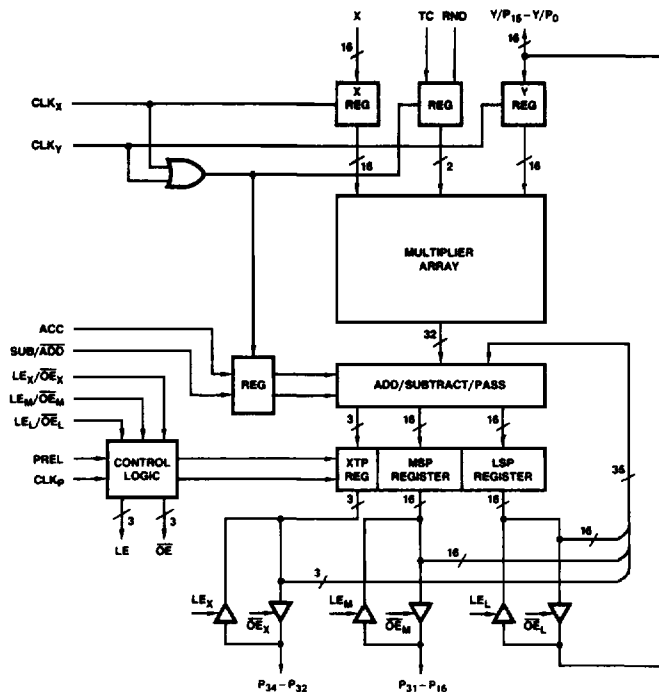

BDR02280

### CONNECTION DIAGRAM Top View

Dual In-Line

Leadless Chip Carrier

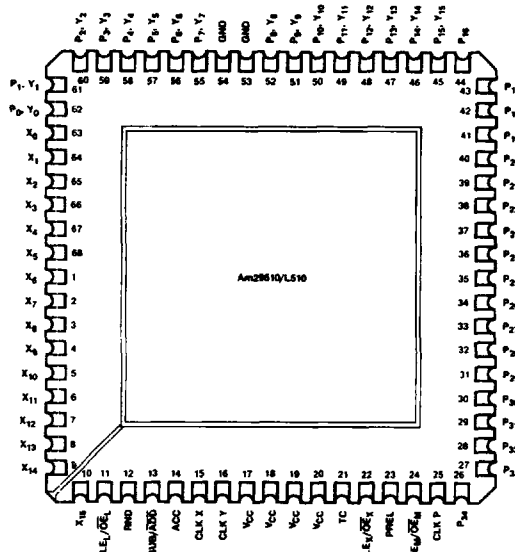
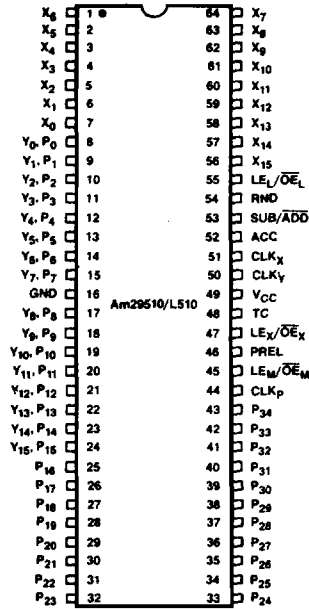

CDR04440

CDR04430

Note: Pin 1 is marked for orientation

7

### METALLIZATION AND PAD LAYOUT

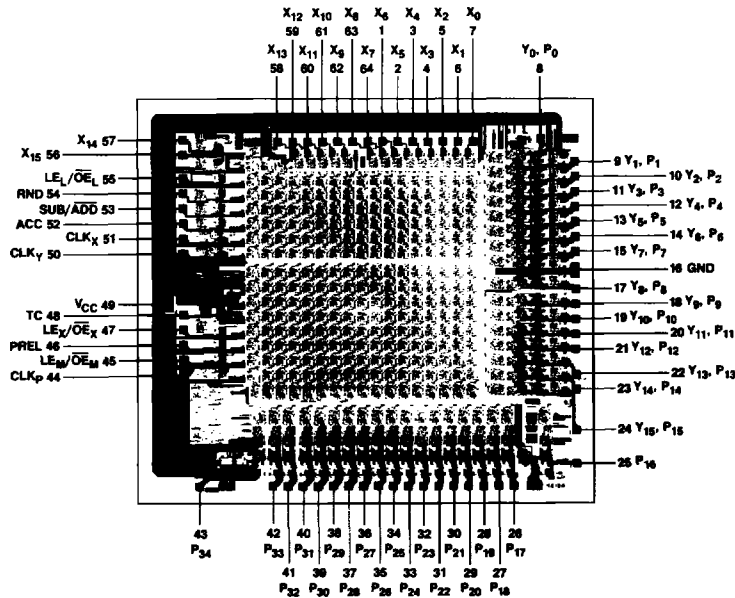

DIE SIZE: .291" x .258"

**ORDERING INFORMATION**

AMD products are available in several packages and operating ranges. The order number is formed by a combination of the following: Device number, speed option (if applicable), package type, operating range and screening option (if desired).

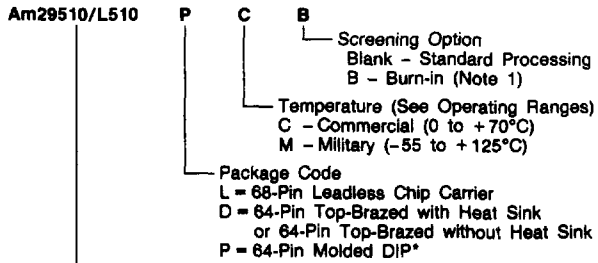

Device Type  
Multiplier Accumulator

Note 1. 180-hour burn-in —  
Heat sink parts:  $T_A = 125^\circ\text{C}$   
Non-heat sink parts:  $T_A = 85^\circ\text{C}$

Valid Combinations	
Am29510	DC, DCB, DMB, LC, LMB, PC*, PCB*
Am29L510	PCB*

**Valid Combinations**

Consult the AMD sales office in your area to determine if a device is currently available in the combination you wish.

## PIN DESCRIPTION

*Pin No.	Name	I/O	Description
54	RND	I	Round When RND is High, a bit with a weight of P <sub>15</sub> is added to the multiplier product. RND is loaded on the rising edge of CLK <sub>X</sub> or CLK <sub>Y</sub> .
48	TC	I	Two's Complement When High, the X and Y inputs are defined as two's complement data, or as unsigned data when Low. The TC control is loaded on the rising edge of CLK <sub>X</sub> or CLK <sub>Y</sub> .
46	PREL	I	Preload When High, data is preloaded into the specific output register when its respective Load Enable is High. When Low, the accumulator register is available at the P-port when the Output Enables are Low.
47	LE <sub>X</sub> /OE <sub>X</sub>	I	Load Enable Extended/Output Enable Extended Active High Load Enable for the XTP port during preloading. Active Low three-state control for the XTP port during normal operation (see Preload Function). (TSX)**
45	LE <sub>M</sub> /OE <sub>M</sub>	I	Load Enable Most/Output Enable Most Active High Load Enable for the MSP port during preloading. Active Low three-state control for the MSP port during normal operation (see Preload Function). (TSM)**
55	LE <sub>L</sub> /OE <sub>L</sub>	I	Load Enable Least/Output Enable Least Active High Load Enable for the LSP port during preloading. Active Low three-state control for the LSP port during normal operation (see Preload Function). (TSL)**
51, 50	CLK <sub>X</sub> , CLK <sub>Y</sub>	I	CLOCKS Load X and Y data respectively and TC, RND, ACC and SUB/ADD on the rising edge.
44	CLK <sub>P</sub>	I	CLOCK Loads data into the XTP, MSP and LSP registers on the rising edge.
1-7, 56-64	X <sub>15</sub> -X <sub>0</sub>	I	Multiplier Data Input Data is loaded into the X register on the rising edge of CLK <sub>X</sub> .
8-15, 17-24	Y <sub>15</sub> -Y <sub>0</sub> P <sub>15</sub> -P <sub>0</sub>	I/O	Bidirectional Port Data is loaded into the Y register on the rising edge of CLK <sub>Y</sub> . Product output for Least Significant Product (LSP) and input to preload LSP register.
41-43	P <sub>34</sub> -P <sub>32</sub>	I/O	Bidirectional Port Product output for Extended Product (XTP) and input to preload XTP register.
25-40	P <sub>31</sub> -P <sub>16</sub>	I/O	Bidirectional Port Product output for the Most Significant Product (MSP) and input to preload MSP register.
52	ACC	I	Accumulate When High, the multiplier product is accumulated in the accumulator. When Low, the multiplier product is written into the accumulator (see Accumulator Function Table). The ACC control is loaded on the rising edge of CLK <sub>X</sub> or CLK <sub>Y</sub> .
53	SUB/ADD	I	Subtraction/Addition When High, the accumulator contents are subtracted from the multiplier product and the result written back into the accumulator. When Low, the multiplier product is added into the accumulator (see Accumulator Function Table). The SUB/ADD control is loaded on the rising edge of CLK <sub>X</sub> or CLK <sub>Y</sub> .

\*DIP Configuration

\*\*TRW TDC1010 Pin Designation

## PRELOAD FUNCTION

PREL	LE <sub>X</sub> / OE <sub>X</sub>	LE <sub>M</sub> / OE <sub>M</sub>	LE <sub>L</sub> / OE <sub>L</sub>	Output Register		
				XTP	MSP	LSP
0	0	0	0	Q	Q	Q
0	0	0	1	Q	Q	Z
0	0	1	0	Q	Z	Q
0	0	1	1	Q	Z	Z
0	1	0	0	Z	Q	Q
0	1	0	1	Z	Q	Z
0	1	1	0	Z	Z	Q
0	1	1	1	Z	Z	Z
1	0	0	0	Z	Z	Z
1	0	0	1	Z	Z	PL
1	0	1	0	Z	PL	Z
1	0	1	1	Z	PL	PL
1	1	0	0	PL	Z	Z
1	1	0	1	PL	Z	PL
1	1	1	0	PL	PL	Z
1	1	1	1	PL	PL	PL

Z = output buffers at High impedance (disabled).  
Q = output buffers at Low impedance. Contents of output register available through output ports.  
PL = output disabled. Preload data supplied to the output pins will be loaded into the output register at the rising edge of CLK<sub>P</sub>.

## ACCUMULATOR FUNCTION TABLE

PREL	ACC	SUB/ ADD	P	OPERATION
L	L	X	Q	Load
L	H	L	Q	Add
L	H	H	Q	Subtract
H	X	X	PL	Preload

7

## DETAILED DESCRIPTION

The Am29510 is a high-speed 16 x 16-bit multiplier/accumulator (MAC). It comprises a 16-bit parallel multiplier followed by a 35-bit accumulator. Two 16-bit input registers are provided for the X and Y operands. A third register stores two control bits, TC and RND. TC selects either a two's complement or an unsigned magnitude format for both data inputs. The RND control, when High, causes a bit to be added to the multiplier product with the weight of  $P_{15}$ . This causes the most significant 16-bits of the product to be rounded to the value nearest to the full 32-bit product. Using the RND control once during an accumulation causes the most significant 19-bits of the accumulator to be rounded to the value nearest the full 35-bit accumulation. The TC/RND register is clocked whenever the X or Y input registers are clocked.

The 32-bit multiplier output is zero-filled or sign-extended as appropriate to provide a 35-bit input to the accumulator. The accumulator has four functions: the product may be loaded into the accumulator, the product may be added into the

accumulator value, the previous accumulator value may be subtracted from the product and the result stored in the accumulator or the accumulator may be preloaded from an external source. The operation of the accumulator is controlled by the signals ACC, SUB/ADD and PREL. ACC and SUB/ADD are stored in a register clocked whenever the X or Y registers are clocked. ACC in conjunction with SUB/ADD selects one of the first three accumulator functions (see Accumulator Function Table). For output and preloading purposes the accumulator is considered in three sections: Extended Product (XTP,  $P_{34}$ - $P_{32}$ ) controlled by  $LE_X/\overline{OE}_X$ , Most Significant Product (MSP,  $P_{31}$ - $P_{16}$ ) controlled by  $LE_M/\overline{OE}_M$  and Least Significant Product (LSP,  $P_{15}$ - $P_0$ ) controlled by  $LE_L/\overline{OE}_L$ . When PREL is Low these controls are active-Low Output Enables for three-state output buffers. When PREL is High the output buffers automatically become high impedance, and the controls operate as active-High Load Enables to the three sections of the accumulator to permit preloading of data applied to the bidirectional P port. The P-port has 35 bits, the least significant 16 of which share pins with the Y input.

### Am29510/L510 INPUT FORMATS

#### Fractional Two's Complement Input

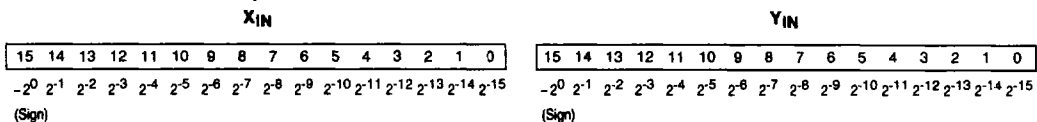

#### Integer Two's Complement Input

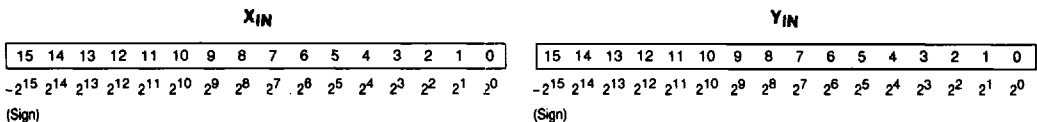

#### Unsigned Fractional Input

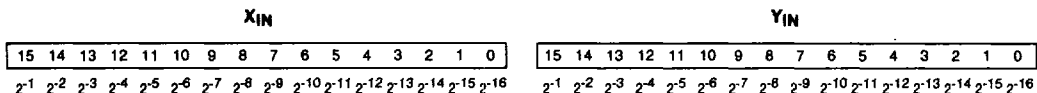

#### Unsigned Integer Input

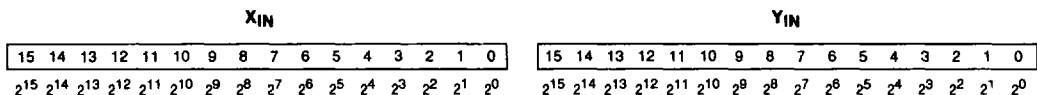

## Am29510/L510 OUTPUT FORMATS

### Two's Complement Fractional Output

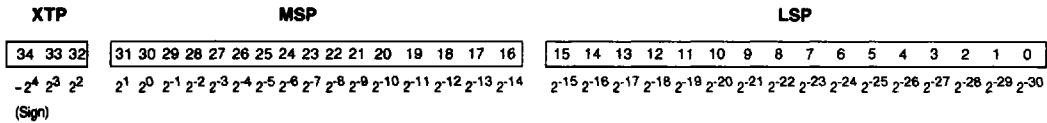

### Two's Complement Integer Output

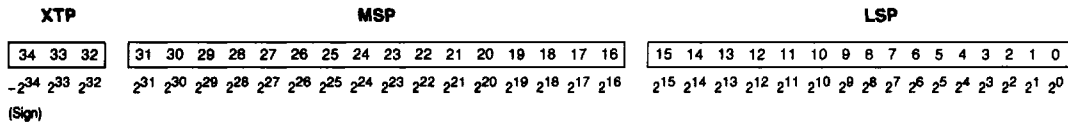

### Unsigned Fractional Output

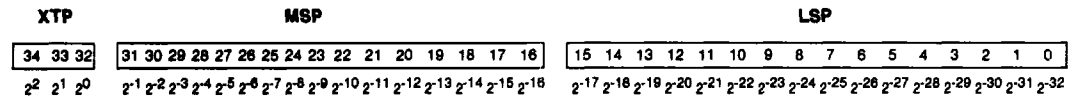

### Unsigned Integer Output

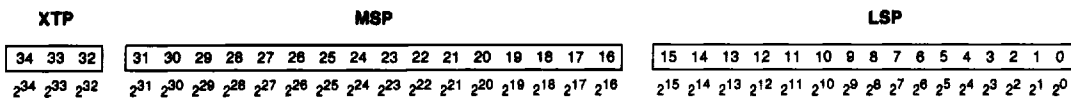

**ABSOLUTE MAXIMUM RATINGS**

Storage Temperature .....	-65 to +150°C
Temperature Under Bias-T <sub>C</sub> .....	-55 to +125°C
Supply Voltage to Ground Potential Continuous .....	-0.5 to +7.0V
DC Voltage Applied to Outputs For High Output State .....	-0.5V to +V <sub>CC</sub> max
DC Input Voltage .....	-0.5 to +5.5V
DC Output Current, Into Outputs .....	30mA
DC Input Current .....	-30 to +5.0mA

Stresses above those listed under ABSOLUTE MAXIMUM RATINGS may cause permanent device failure. Functionality at or above these limits is not implied. Exposure to absolute maximum ratings for extended periods may affect device reliability.

**OPERATING RANGES****Commercial (C) Devices**

Temperature	
DIPs .....	T <sub>A</sub> = 0 to +70°C
Chip Carriers .....	T <sub>C</sub> = 0 to +85°C
Supply Voltage .....	4.75V to 5.25V

**Military (M) Devices**

Temperature .....	T <sub>C</sub> = -55°C to +125°C
Supply Voltage .....	4.5V to 5.5V

Operating ranges define those limits over which the functionality of the device is guaranteed.

**DC CHARACTERISTICS** over operating range unless otherwise specified  
**Am29510**

Parameters	Description	Test Conditions (Note 1)		Min	Typ (Note 2)	Max	Units
V <sub>OH</sub>	Output HIGH Voltage	V <sub>CC</sub> = MIN V <sub>IN</sub> = V <sub>IH</sub> or V <sub>IL</sub>	I <sub>OH</sub> = -0.4mA	2.4	2.7		Volts
V <sub>OL</sub>	Output LOW Voltage	V <sub>CC</sub> = MIN V <sub>IN</sub> = V <sub>IH</sub> or V <sub>IL</sub>	I <sub>OL</sub> = 4.0mA			.5	Volts
V <sub>IH</sub>	Input HIGH Level	Guaranteed input logical HIGH voltage for all inputs		2			Volts
V <sub>IL</sub>	Input LOW level	Guaranteed input logical LOW voltage for all inputs				.8	Volts
V <sub>I</sub>	Input Clamp Voltage	V <sub>CC</sub> = MIN, I <sub>IN</sub> = -18mA				-1.5	Volts
I <sub>IL</sub>	Input LOW Current	V <sub>CC</sub> = MAX, V <sub>IN</sub> = 0.4V				-0.4	mA
I <sub>IH</sub>	Input HIGH Current	V <sub>CC</sub> = MAX, V <sub>IN</sub> = 2.4V				75	μA
I <sub>I</sub>	Input HIGH Current	V <sub>CC</sub> = MAX, V <sub>IN</sub> = 2.4V				1	mA
I <sub>OZH</sub>	Off State (High Impedance) Output Current	V <sub>CC</sub> = MAX	V <sub>O</sub> = 2.4V			25	μA
I <sub>OZL</sub>	Output Current	V <sub>CC</sub> = MAX	V <sub>O</sub> = 0.4V			-25	μA
I <sub>SC</sub>	Output Short Circuit Current (Note 3)	V <sub>CC</sub> = MAX	V <sub>O</sub> = 0V	-3		-30	mA
I <sub>CC</sub>	Power Supply Current	COM'L and MIL			750		mA
		COM'L Only V <sub>CC</sub> = Max		T <sub>A</sub> = 25°C		900	
				T <sub>A</sub> = 0 to +70°C (Note 4)		725	
				T <sub>A</sub> = +70°C (Note 4)		1000	
		MIL Only V <sub>CC</sub> = Max				750	

- Notes: 1. For conditions shown as MIN or MAX, use the appropriate value specified under Operating Ranges for the applicable device type.  
 2. Typical limits are at V<sub>CC</sub> = 5.0V, 25°C ambient and maximum loading.  
 3. Not more than one output should be shorted at a time. Duration of the short circuit test should not exceed one second.  
 4. Chip Carriers: T<sub>A</sub> = 85°C.

**DC CHARACTERISTICS** over operating range unless otherwise specified  
**Am29L510**

Parameters	Description	Test Conditions (Note 1)		Min	Typ (Note 2)	Max	Units
V <sub>OH</sub>	Output HIGH Voltage	V <sub>CC</sub> = MIN V <sub>IN</sub> = V <sub>IH</sub> or V <sub>IL</sub>	I <sub>OH</sub> = -0.4mA	4	7		Volts
V <sub>OL</sub>	Output LOW Voltage	V <sub>CC</sub> = MIN V <sub>IN</sub> = V <sub>IH</sub> or V <sub>IL</sub>	I <sub>OL</sub> = 4.0mA			.5	Volts
V <sub>IH</sub>	Input HIGH Level	Guaranteed input logical HIGH voltage for all inputs		2.0			Volts
V <sub>IL</sub>	Input LOW Level	Guaranteed input logical LOW voltage for all inputs				.8	Volts
V <sub>I</sub>	Input Clamp Voltage	V <sub>CC</sub> = MIN, I <sub>IN</sub> = 10mA				-1.5	Volts
I <sub>IL</sub>	Input LOW Current	V <sub>CC</sub> = MAX, V <sub>IN</sub> = 0V				-0.4	mA
I <sub>IH</sub>	Input HIGH Current	V <sub>CC</sub> = MAX, V <sub>IN</sub> = 5V				75	μA
I <sub>I</sub>	Input HIGH Current	V <sub>CC</sub> = MAX, V <sub>IN</sub> = 5V				1	mA
I <sub>OZH</sub>	Off State (High Impedance) Output Current	V <sub>CC</sub> = MIN	Product	V <sub>O</sub> = 2.4V		25	μA
I <sub>OZL</sub>	Off State (High Impedance) Output Current		Product	V <sub>O</sub> = 0.4V		-25	
I <sub>SC</sub>	Output Short Circuit Current (Note 3)	V <sub>CC</sub> = MAX	Y	V <sub>O</sub> = 0V	-3	-30	mA
			Product	V <sub>O</sub> = 0V	-3	-30	
I <sub>CC</sub>	Power Supply Current	COM'L and MIL		T <sub>A</sub> = 25°C		330	mA
		COM'L Only V <sub>CC</sub> = Max		T <sub>A</sub> = 0 to +70°C (Note 4)		450	
		COM'L Only V <sub>CC</sub> = Max		T <sub>A</sub> = +70°C (Note 4)		350	
		MIL Only V <sub>CC</sub> = Max		T <sub>CC</sub> = -55 to +125°C		535	
MIL Only V <sub>CC</sub> = Max		T <sub>CC</sub> = +125°C		375			

- Notes: 1. For conditions shown as MIN or MAX, use the appropriate value specified under Operating Ranges for the applicable device type.  
 2. Typical limits are at V<sub>CC</sub> = 5.0V, 25°C ambient and maximum loading.  
 3. Not more than one output should be shorted at a time. Duration of the short circuit test should not exceed one second.  
 4. Chip Carriers, T<sub>C</sub> = 85°C.



**SWITCHING CHARACTERISTICS** over operating range unless otherwise specified

Parameters	Description	Test Conditions	Typ (Note 1)	COMMERCIAL		MILITARY		Units
				29510		29510		
				Min	Max	Min	Max	
t <sub>MA</sub>	Multiply Accumulate Time		50	80		90	ns	
t <sub>S</sub>	X <sub>i</sub> , Y <sub>i</sub> , RND, TC, ACC, SUB/ADD Set-up Time		12	25	30		ns	
t <sub>H</sub>	X <sub>i</sub> , Y <sub>i</sub> , RND, TC, ACC, SUB/ADD Hold Time		0	5	5		ns	
t <sub>S</sub>	PREL Setup Time		10	25	30		ns	
t <sub>H</sub>	PREL Hold Time		0	0	2		ns	
t <sub>PWH</sub>	Clock Pulse Width High		10	20	25		ns	
t <sub>PWL</sub>	Clock Pulse Width Low		10	20	25		ns	
t <sub>POP</sub>	Output Clock to P		25	40		40	ns	
t <sub>PDY</sub>	Output Clock to Y		25	40		40	ns	
t <sub>PHZ</sub>	LE <sub>X</sub> /OE <sub>X</sub> , LE <sub>M</sub> /OE <sub>M</sub> to P, LE <sub>L</sub> /OE <sub>L</sub> to Y Disable Time	High to Z	21	35		40	ns	
t <sub>PLZ</sub>	LE <sub>X</sub> /OE <sub>X</sub> , LE <sub>M</sub> /OE <sub>M</sub> to Y Enable Time	Low to Z	20	35		40	ns	
t <sub>PZH</sub>	LE <sub>X</sub> /OE <sub>X</sub> , LE <sub>M</sub> /OE <sub>M</sub> to P, LE <sub>L</sub> /OE <sub>L</sub> to Y Enable Time	Z to High	28	40		40	ns	
t <sub>PZL</sub>	LE <sub>X</sub> /OE <sub>X</sub> , LE <sub>M</sub> /OE <sub>M</sub> to Y Enable Time	Z to Low	24	40		40	ns	
t <sub>HCL</sub>	Relative Hold Time				0		ns	

**SWITCHING CHARACTERISTICS** over operating range unless otherwise specified\*

Parameters	Description	Test Conditions	Typ (Note 1)	COMMERCIAL		MILITARY		Units
				29L510		29L510		
				Min	Max	Min	Max	
t <sub>MA</sub>	Multiply Accumulate Time		70	110		120	ns	
t <sub>S</sub>	X <sub>i</sub> , Y <sub>i</sub> , RND, TC, ACC, SUB/ADD Set-up Time		20	40	45		ns	
t <sub>H</sub>	X <sub>i</sub> , Y <sub>i</sub> , RND, TC, ACC, SUB/ADD Hold Time		-3	0	0		ns	
t <sub>S</sub>	PREL Set-up Time		15	27	35		ns	
t <sub>H</sub>	PREL Hold Time		-5	0	0		ns	
t <sub>PWH</sub>	Clock Pulse Width High		15	25	30		ns	
t <sub>PWL</sub>	Clock Pulse Width Low		15	25	30		ns	
t <sub>POP</sub>	Output Clock to P		35	45		50	ns	
t <sub>PDY</sub>	Output Clock to Y		35	45		50	ns	
t <sub>PHZ</sub>	LE <sub>X</sub> /OE <sub>X</sub> , LE <sub>M</sub> /OE <sub>M</sub> to P, LE <sub>L</sub> /OE <sub>L</sub> to Y Disable Time	High to Z	24	35		40	ns	
t <sub>PLZ</sub>	LE <sub>X</sub> /OE <sub>X</sub> , LE <sub>M</sub> /OE <sub>M</sub> to Y Enable Time	Low to Z	25	35		40	ns	
t <sub>PZH</sub>	LE <sub>X</sub> /OE <sub>X</sub> , LE <sub>M</sub> /OE <sub>M</sub> to P, LE <sub>L</sub> /OE <sub>L</sub> to Y Enable Time	Z to High	38	45		50	ns	
t <sub>PZL</sub>	LE <sub>X</sub> /OE <sub>X</sub> , LE <sub>M</sub> /OE <sub>M</sub> to Y Enable Time	Z to Low	32	40		45	ns	
t <sub>HCL</sub>	Relative Hold Time			0	0		ns	

Note: 1. Typical limits are V<sub>CC</sub> = 5V and T<sub>A</sub> = 25°C.

**SWITCHING TEST CIRCUIT**

**Normal Load**

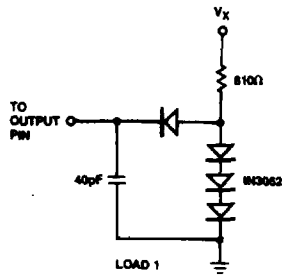

TCR01270

**Three-State Delay Load**

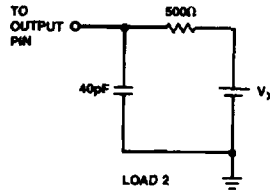

TCR01280

**SWITCHING TEST WAVEFORMS**

Test	V <sub>x</sub>	Output Waveform - Measurement Level
All t <sub>PD</sub> s	V <sub>CC</sub>	
t <sub>PHZ</sub>	0.0V	
t <sub>PLZ</sub>	2.6V	
t <sub>PZH</sub>	0.0V	
t <sub>PZL</sub>	2.6V	

WFR02810

7

**SET-UP AND HOLD TIME**

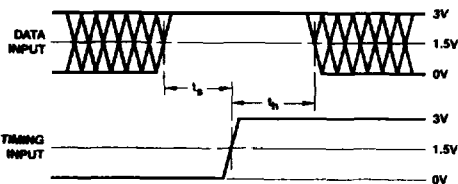

WFR02970

**PULSE WIDTH**

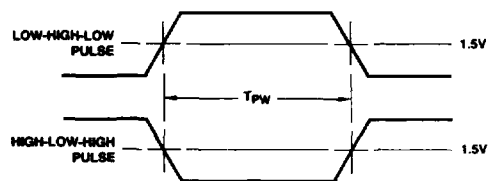

WFR02850

- Notes: 1. Diagram shown for HIGH data only. Output transition may be opposite sense.  
 2. Cross hatched area is don't care condition.

### Am29510/L510 TIMING DIAGRAMS

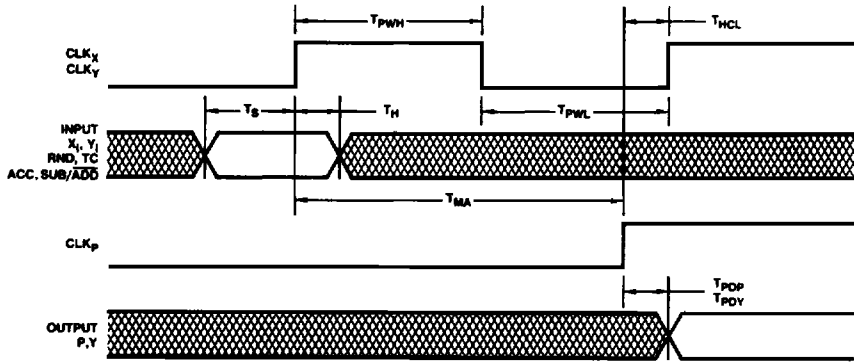

WFR02820

### Am29510/L510 PRELOAD TIMING DIAGRAM

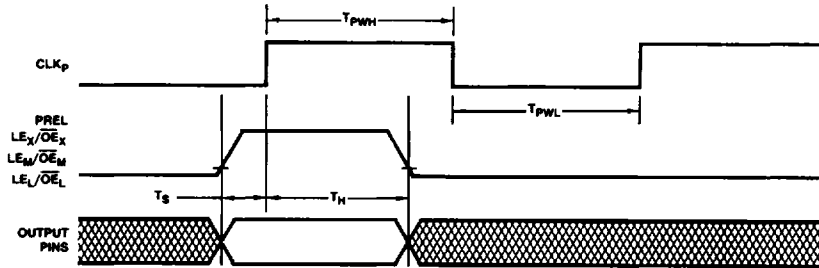

WFR02830

### Am29510/L510 THREE-STATE TIMING DIAGRAM

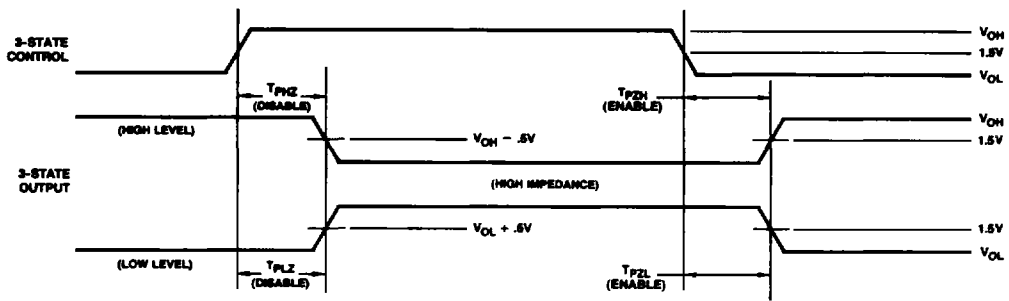

WFR02840

## INPUT/OUTPUT CURRENT INTERFACE CONDITIONS

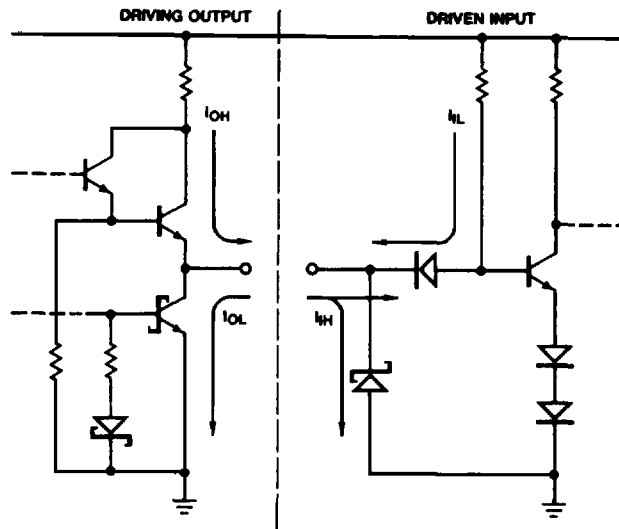

ICR00490

## RELATED PRODUCTS

Part No.	Description
Am29526/527	High speed Sine function generator
Am29528/529	High Speed Cosine function generator
Am29540	Programmable FFT address sequencer
Am29520/21	Multilevel pipeline registers