

(2,54mm) .100"

LST, HLST SERIES

SELF-MATING HERMAPHRODITIC STRIP

SPECIFICATIONS

For complete specifications see www.samtec.com?LST or www.samtec.com?HLST

LST

Insulator Material: LST: Black
Glass Filled Polyester
Terminal Material: Phosphor Bronze
Contact Material: Phosphor Bronze
Plating: Au or Sn over 50µ" (1,27µm) Ni
Operating Temp Range: -55°C to +125°C with Gold
-55°C to +105°C with Tin
Insertion Depth: (3,68 mm) .145" to (6,35 mm) .250"
Insertion Force: (Single contact only) 6oz (1,67N) avg
Withdrawal Force: (Single contact only) 4oz (1,11N) avg
Cycles: 100 with 10µ" (0,25µm) Au
RoHS Compliant: Yes
Lead-Free Solderable: Wave Only



CURRENT RATING	
AMBIENT TEMP	5 Contacts
20°C	6.0A
40°C	5.3A
60°C	4.2A
80°C	3.0A

Note: Other Gold plating options available. Contact Samtec.

Note: Some lengths, styles and options are non-standard, non-returnable.

Mates with: LST, HLST

Hermaphroditic self-mating header/socket system



One part number for both socket and terminal

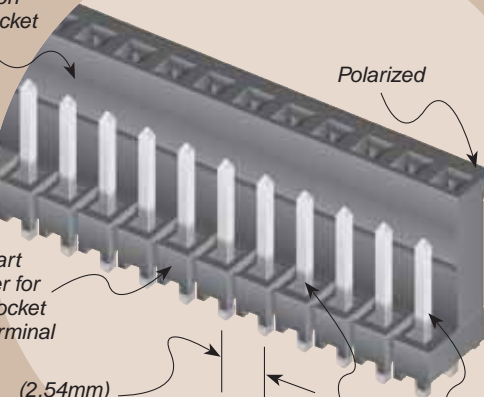

(2,54mm) .100" pitch

(0,64mm) .025" square post

APPLICATION

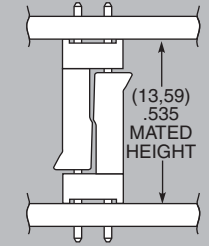

(13,59) .535 MATED HEIGHT

Locking feature increases unmating force and provides audible "click" when properly mated

TYPE STRIP	1	NO. PINS PER ROW	07	PLATING OPTION	D
LST = Standard		02 thru 30		-F = Gold flash on contact area, Matte Tin on tail	
HLST = High Temperature				-G = 10µ" (0,25µm) Gold on contact area, Gold flash on balance	
				-T = Matte Tin	

Also Available

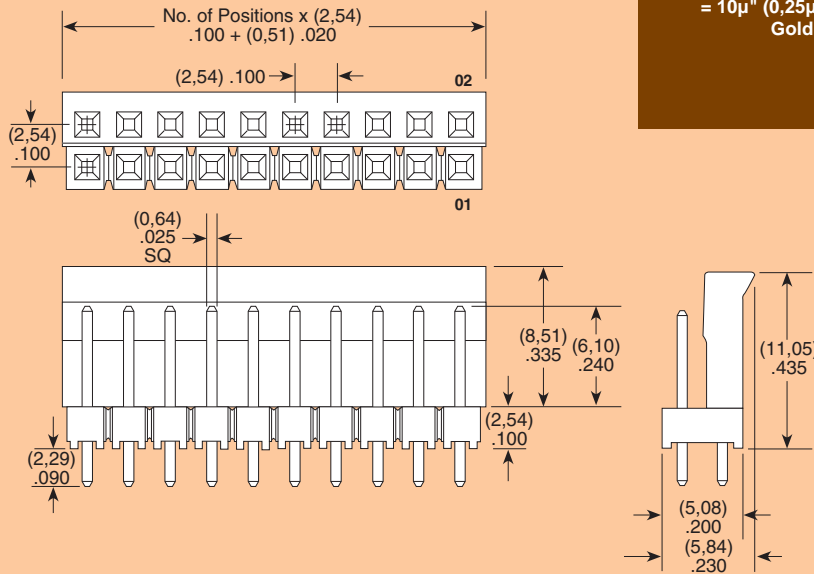
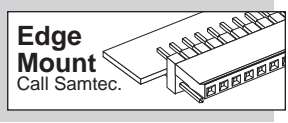
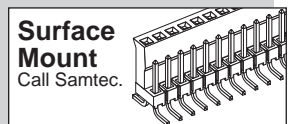
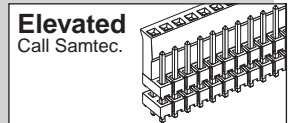
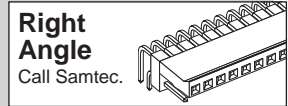

Due to technical progress, all designs, specifications and components are subject to change without notice.

WWW.SAMTEC.COM