

Intel® Desktop Board DP45SG Technical Product Specification

June 2008

Order Number: E35965-001

The Intel® Desktop Board DP45SG may contain design defects or errors known as errata that may cause the product to deviate from published specifications. Current characterized errata are documented in the Intel Desktop Board DP45SG Specification Update.

Revision History

| Revision | Revision History | Date |
|----------|----------------------------------------------------------------------------------|-----------|
| -001 | First release of the Intel® Desktop Board DP45SG Technical Product Specification | June 2008 |

This product specification applies to only the standard Intel® Desktop Board DP45SG with BIOS identifier SGP4510H.86A.

Changes to this specification will be published in the Intel Desktop Board DP45SG Specification Update before being incorporated into a revision of this document.

INFORMATION IN THIS DOCUMENT IS PROVIDED IN CONNECTION WITH INTEL® PRODUCTS. NO LICENSE, EXPRESS OR IMPLIED, BY ESTOPPEL OR OTHERWISE, TO ANY INTELLECTUAL PROPERTY RIGHTS IS GRANTED BY THIS DOCUMENT. EXCEPT AS PROVIDED IN INTEL'S TERMS AND CONDITIONS OF SALE FOR SUCH PRODUCTS, INTEL ASSUMES NO LIABILITY WHATSOEVER, AND INTEL DISCLAIMS ANY EXPRESS OR IMPLIED WARRANTY, RELATING TO SALE AND/OR USE OF INTEL PRODUCTS INCLUDING LIABILITY OR WARRANTIES RELATING TO FITNESS FOR A PARTICULAR PURPOSE, MERCHANTABILITY, OR INFRINGEMENT OF ANY PATENT, COPYRIGHT OR OTHER INTELLECTUAL PROPERTY RIGHT. UNLESS OTHERWISE AGREED IN WRITING BY INTEL, THE INTEL PRODUCTS ARE NOT DESIGNED NOR INTENDED FOR ANY APPLICATION IN WHICH THE FAILURE OF THE INTEL PRODUCT COULD CREATE A SITUATION WHERE PERSONAL INJURY OR DEATH MAY OCCUR.

All Intel® desktop boards are evaluated as Information Technology Equipment (I.T.E.) for use in personal computers (PC) for installation in homes, offices, schools, computer rooms, and similar locations. The suitability of this product for other PC or embedded non-PC applications or other environments, such as medical, industrial, alarm systems, test equipment, etc. may not be supported without further evaluation by Intel.

Intel Corporation may have patents or pending patent applications, trademarks, copyrights, or other intellectual property rights that relate to the presented subject matter. The furnishing of documents and other materials and information does not provide any license, express or implied, by estoppel or otherwise, to any such patents, trademarks, copyrights, or other intellectual property rights.

Intel may make changes to specifications and product descriptions at any time, without notice.

Designers must not rely on the absence or characteristics of any features or instructions marked "reserved" or "undefined." Intel reserves these for future definition and shall have no responsibility whatsoever for conflicts or incompatibilities arising from future changes to them.

Intel desktop boards may contain design defects or errors known as errata, which may cause the product to deviate from published specifications. Current characterized errata are available on request.

Contact your local Intel sales office or your distributor to obtain the latest specifications before placing your product order.

Copies of documents which have an ordering number and are referenced in this document, or other Intel literature, may be obtained from:

Intel Corporation
P.O. Box 5937
Denver, CO 80217-9808

or call in North America 1-800-548-4725, Europe 44-0-1793-431-155, France 44-0-1793-421-777, Germany 44-0-1793-421-333, other Countries 708-296-9333.

Intel, the Intel logo, Pentium, Core, and Celeron are registered trademarks of Intel Corporation in the United States and other countries.

* Other names and brands may be claimed as the property of others.

Copyright © 2008, Intel Corporation. All rights reserved.

Preface

This Technical Product Specification (TPS) specifies the board layout, components, connectors, power and environmental requirements, and the BIOS for the Intel® Desktop Board DP45SG.

Intended Audience

The TPS is intended to provide detailed, technical information about the Intel Desktop Board DP45SG and its components to the vendors, system integrators, and other engineers and technicians who need this level of information. It is specifically *not* intended for general audiences.

What This Document Contains

| Chapter | Description |
|---------|----------------------------------------------------------------------|
| 1 | A description of the hardware used on the Intel Desktop Board DP45SG |
| 2 | A map of the resources of the Desktop Board |
| 3 | The features supported by the BIOS Setup program |
| 4 | A description of the BIOS error messages, beep codes, and POST codes |
| 5 | Regulatory compliance and battery disposal information |

Typographical Conventions

This section contains information about the conventions used in this specification. Not all of these symbols and abbreviations appear in all specifications of this type.

Notes, Cautions, and Warnings



NOTE

Notes call attention to important information.



INTEGRATOR'S NOTES

Integrator's notes are used to call attention to information that may be useful to system integrators.



CAUTION

Cautions are included to help you avoid damaging hardware or losing data.

Other Common Notation

| | |
|-----------|-------------------------------------------------------------------------------------------------------------------------------------------------------------------------------------------------------------------------------------------------------------------------------------------------------------------------------|
| # | Used after a signal name to identify an active-low signal (such as USBP0#) |
| (NxnX) | When used in the description of a component, N indicates component type, xn are the relative coordinates of its location on the Intel Desktop Board DP45SG, and X is the instance of the particular part at that general location. For example, J5J1 is a connector, located at 5J. It is the first connector in the 5J area. |
| GB | Gigabyte (1,073,741,824 bytes) |
| GB/sec | Gigabytes per second |
| Gbits/sec | Gigabits per second |
| KB | Kilobyte (1024 bytes) |
| Kbit | Kilobit (1024 bits) |
| kbits/sec | 1000 bits per second |
| MB | Megabyte (1,048,576 bytes) |
| MB/sec | Megabytes per second |
| Mbit | Megabit (1,048,576 bits) |
| Mbits/sec | Megabits per second |
| xxh | An address or data value ending with a lowercase h indicates a hexadecimal value. |
| x.x V | Volts. Voltages are DC unless otherwise specified. |
| * | This symbol is used to indicate third-party brands and names that are the property of their respective owners. |

Contents

| | | |
|----------|-------------------------------------------------|-----------|
| 1 | Product Description | 9 |
| 1.1 | Overview..... | 9 |
| 1.1.1 | Feature Summary | 9 |
| 1.1.2 | Board Layout..... | 11 |
| 1.1.3 | Block Diagram | 13 |
| 1.2 | Legacy Considerations..... | 14 |
| 1.3 | Online Support..... | 14 |
| 1.4 | Processor | 14 |
| 1.5 | System Memory | 15 |
| 1.5.1 | Memory Configurations | 16 |
| 1.6 | Intel® P45 Chipset..... | 18 |
| 1.6.1 | PCI Express x16 Graphics..... | 18 |
| 1.6.2 | USB | 19 |
| 1.6.3 | Serial ATA Interfaces | 19 |
| 1.7 | Real-Time Clock Subsystem | 21 |
| 1.8 | Legacy I/O Controller..... | 22 |
| 1.8.1 | Consumer Infrared (CIR)..... | 22 |
| 1.9 | Audio Subsystem..... | 23 |
| 1.9.1 | Audio Subsystem Software | 23 |
| 1.9.2 | Audio Connectors and Headers | 24 |
| 1.10 | LAN Subsystem..... | 25 |
| 1.10.1 | Intel® 82567LF Gigabit Ethernet Controller..... | 25 |
| 1.10.2 | LAN Subsystem Software..... | 26 |
| 1.10.3 | RJ-45 LAN Connector with Integrated LEDs | 26 |
| 1.11 | Hardware Management Subsystem | 27 |
| 1.11.1 | Hardware Monitoring and Fan Control..... | 27 |
| 1.11.2 | Fan Monitoring..... | 27 |
| 1.11.3 | Chassis Intrusion and Detection..... | 27 |
| 1.11.4 | Thermal Monitoring | 28 |
| 1.12 | Power Management | 29 |
| 1.12.1 | ACPI..... | 29 |
| 1.12.2 | Hardware Support | 32 |
| 1.12.3 | ENERGY STAR* | 36 |
| 2 | Technical Reference..... | 37 |
| 2.1 | Memory Resources | 37 |
| 2.1.1 | Addressable Memory..... | 37 |
| 2.1.2 | Memory Map..... | 39 |
| 2.2 | Connectors and Headers..... | 39 |
| 2.2.1 | Back Panel Connectors..... | 40 |
| 2.2.2 | Component-side Connectors and Headers | 41 |
| 2.3 | Jumper Block..... | 51 |
| 2.4 | Mechanical Considerations | 52 |

| | | |
|----------|-----------------------------------------------------------------|-----------|
| 2.4.1 | Form Factor..... | 52 |
| 2.5 | Electrical Considerations..... | 53 |
| 2.5.1 | Power Supply Considerations..... | 53 |
| 2.5.2 | Fan Header Current Capability..... | 54 |
| 2.5.3 | Add-in Board Considerations..... | 54 |
| 2.6 | Thermal Considerations..... | 54 |
| 2.7 | Reliability..... | 57 |
| 2.8 | Environmental..... | 57 |
| 3 | Overview of BIOS Features..... | 59 |
| 3.1 | Introduction..... | 59 |
| 3.2 | BIOS Flash Memory Organization..... | 60 |
| 3.3 | Resource Configuration..... | 60 |
| 3.3.1 | PCI Autoconfiguration..... | 60 |
| 3.4 | System Management BIOS (SMBIOS)..... | 61 |
| 3.5 | Legacy USB Support..... | 61 |
| 3.6 | BIOS Updates..... | 62 |
| 3.6.1 | Language Support..... | 62 |
| 3.6.2 | Custom Splash Screen..... | 63 |
| 3.7 | BIOS Recovery..... | 63 |
| 3.8 | Boot Options..... | 64 |
| 3.8.1 | CD-ROM Boot..... | 64 |
| 3.8.2 | Network Boot..... | 64 |
| 3.8.3 | Booting Without Attached Devices..... | 64 |
| 3.8.4 | Changing the Default Boot Device During POST..... | 64 |
| 3.9 | Adjusting Boot Speed..... | 65 |
| 3.9.1 | Peripheral Selection and Configuration..... | 65 |
| 3.9.2 | BIOS Boot Optimizations..... | 65 |
| 3.10 | BIOS Security Features..... | 66 |
| 4 | Error Messages and Beep Codes..... | 67 |
| 4.1 | Speaker..... | 67 |
| 4.2 | BIOS Beep Codes..... | 67 |
| 4.3 | BIOS Error Messages..... | 67 |
| 4.4 | Port 80h POST Codes..... | 68 |
| 5 | Regulatory Compliance and Battery Disposal Information.. | 73 |
| 5.1 | Regulatory Compliance..... | 73 |
| 5.1.1 | Safety Standards..... | 73 |
| 5.1.2 | European Union Declaration of Conformity Statement..... | 74 |
| 5.1.3 | Product Ecology Statements..... | 75 |
| 5.1.4 | EMC Regulations..... | 79 |
| 5.1.5 | Product Certification Markings (Board Level)..... | 80 |
| 5.2 | Battery Disposal Information..... | 81 |

Figures

| | |
|----------------------------------------------------------------|----|
| Figure 1. Major Board Components..... | 11 |
| Figure 2. Block Diagram..... | 13 |
| Figure 3. Memory Channel and DIMM Configuration | 17 |
| Figure 4. Back Panel Audio Connector Options..... | 24 |
| Figure 5. LAN Connector LED Locations | 26 |
| Figure 6. Thermal Sensors and Fan Headers | 28 |
| Figure 7. Location of the Standby Power Indicator LED | 36 |
| Figure 8. Detailed System Memory Address Map..... | 38 |
| Figure 9. Back Panel Connectors | 40 |
| Figure 10. Component-side Connectors and Headers..... | 41 |
| Figure 11. Connection Diagram for Front Panel Header..... | 48 |
| Figure 12. Connection Diagram for Front Panel USB Headers..... | 50 |
| Figure 13. Connection Diagram for IEEE 1394a Header..... | 50 |
| Figure 14. Location of the Jumper Block | 51 |
| Figure 15. Board Dimensions | 52 |
| Figure 16. Localized High Temperature Zones | 56 |

Tables

| | |
|--------------------------------------------------------------------------|----|
| Table 1. Feature Summary | 9 |
| Table 2. Components Shown in Figure 1..... | 12 |
| Table 3. Supported Memory Configurations..... | 15 |
| Table 4. Audio Jack Retasking Support..... | 23 |
| Table 5. LAN Connector LED States | 26 |
| Table 6. Effects of Pressing the Power Switch..... | 30 |
| Table 7. Power States and Targeted System Power | 31 |
| Table 8. Wake-up Devices and Events..... | 32 |
| Table 9. System Memory Map..... | 39 |
| Table 10. Component-side Connectors and Headers Shown in Figure 10 | 42 |
| Table 11. HD Audio Link Header..... | 43 |
| Table 12. Front Panel Audio Header..... | 43 |
| Table 13. Serial ATA Connectors | 43 |
| Table 14. Serial Port Header..... | 43 |
| Table 15. Chassis Intrusion Header | 44 |
| Table 16. Front and Rear Chassis (3-Pin) Fan Headers..... | 44 |
| Table 17. Processor and Rear Chassis 2 (4-Pin) Fan Headers..... | 44 |
| Table 18. S/PDIF Connector | 45 |
| Table 19. Auxiliary Front Panel Power/Sleep LED Header | 46 |
| Table 20. Processor Core Power Connector | 46 |
| Table 21. Main Power Connector | 47 |
| Table 22. Auxiliary PCI Express Graphics Power..... | 47 |
| Table 23. Front Panel Header..... | 48 |
| Table 24. States for a One-Color Power LED | 49 |
| Table 25. States for a Two-Color Power LED | 49 |
| Table 26. BIOS Setup Configuration Jumper Settings | 51 |
| Table 27. Recommended Power Supply Current Values..... | 53 |

Intel Desktop Board DP45SG Technical Product Specification

| | |
|-----------------------------------------------------------------|----|
| Table 28. Fan Header Current Capability | 54 |
| Table 29. Thermal Considerations for Components..... | 56 |
| Table 30. Environmental Specifications | 57 |
| Table 31. BIOS Setup Program Menu Bar | 60 |
| Table 32. BIOS Setup Program Function Keys | 60 |
| Table 33. Acceptable Drives/Media Types for BIOS Recovery | 63 |
| Table 34. Boot Device Menu Options..... | 64 |
| Table 35. Supervisor and User Password Functions | 66 |
| Table 36. Beep Codes..... | 67 |
| Table 37. BIOS Error Messages | 67 |
| Table 38. Port 80h POST Code Ranges | 68 |
| Table 39. Port 80h POST Codes..... | 69 |
| Table 40. Typical Port 80h POST Sequence | 72 |
| Table 41. Safety Standards | 73 |
| Table 42. Lead-Free Board Markings | 78 |
| Table 43. EMC Regulations | 79 |
| Table 44. Product Certification Markings..... | 80 |

1 Product Description

1.1 Overview

1.1.1 Feature Summary

Table 1 summarizes the major features of the board.

Table 1. Feature Summary

| | |
|------------------------------------------|--------------------------------------------------------------------------------------------------------------------------------------------------------------------------------------------------------------------------------------------------------------------------------------------------------------------------------------------------------------------------------------------------------------------------------------------|
| Form Factor | ATX (11.60 inches by 9.60 inches [294.60 millimeters by 243.84 millimeters]) |
| Processor | <ul style="list-style-type: none">• Intel® Core™2 Extreme Processor in an LGA775 socket• Intel® Core™2 Quad Processor in an LGA775 socket• Intel® Core™2 Duo Processor in an LGA775 socket• Intel® Pentium® Dual-Core Processor in an LGA775 socket• Intel® Celeron® Dual-Core Processor in an LGA775 socket• Intel® Celeron® Processor 400 Sequence in an LGA775 socket |
| Memory | <ul style="list-style-type: none">• Four 240-pin DDR3 SDRAM Dual Inline Memory Module (DIMM) sockets• Support for DDR3 1333 MHz, DDR3 1066 MHz, and DDR3 800 MHz DIMMs• Support for up to 8 GB of system memory• Support for non-ECC memory |
| Chipset | Intel® P45 Chipset, consisting of: <ul style="list-style-type: none">• Intel® 82P45 Memory Controller Hub (MCH)• Intel® 82801JR I/O Controller Hub (ICH10R) |
| Audio | 8-channel (7.1) audio subsystem using the IDT* 92HD73E high definition audio codec and Dolby* Home Theater certification |
| Legacy I/O Control | Legacy I/O controller for serial port header and Consumer Infrared (CIR) |
| Peripheral Interfaces | <ul style="list-style-type: none">• Twelve USB 2.0 ports: six back panel connectors and six front panel headers• Two IEEE-1394a interfaces: one back panel connector and one front-panel header• Six Serial ATA (3 Gbps) interfaces, including one red-colored external Serial ATA (eSATA) interface on the back panel• One serial port header (may require specialized chassis or cable for use) |
| BIOS | <ul style="list-style-type: none">• Intel® BIOS resident in the SPI Flash device• Support for Advanced Configuration and Power Interface (ACPI), Plug and Play, and SMBIOS |
| Instantly Available PC Technology | <ul style="list-style-type: none">• Support for PCI Local Bus Specification Revision 2.2• Support for PCI Express* Revision 1.0a• Suspend to RAM support• Wake on PCI, front panel, CIR, and USB ports |
| LAN Support | Gigabit (10/100/1000 Mb/s) LAN subsystem using the Intel® 82567LF Gigabit Ethernet Controller |

continued

Table 1. Feature Summary (continued)

| | |
|-----------------------------------|---------------------------------------------------------------------------------------------------------------------------------------------------------------------------------------------------------------------------------------------------------------------------------------------------------------------------------------------------------------------------------------------------------------------------------------------------------------------------------------------------|
| Expansion Capabilities | <ul style="list-style-type: none">• Three PCI* Conventional bus add-in card connectors (SMBus routed to all PCI Conventional bus add-in card connectors)• Two PCI Express 2.0 x16 bus add-in card connectors• Two PCI Express x1 bus add-in card connector |
| Hardware Monitor Subsystem | <ul style="list-style-type: none">• Hardware monitoring and fan control ASIC• Voltage sense to detect out of range power supply voltages• Thermal sense to detect out of range thermal values• Four fan headers using PWM control• Four fan sense inputs used to monitor fan activity• Fan speed control using voltage control (3-pin fan headers front and rear)• Support for Product Environmental Control Interface (PECI) |

1.1.2 Board Layout

Figure 1 shows the location of the major components on the board.

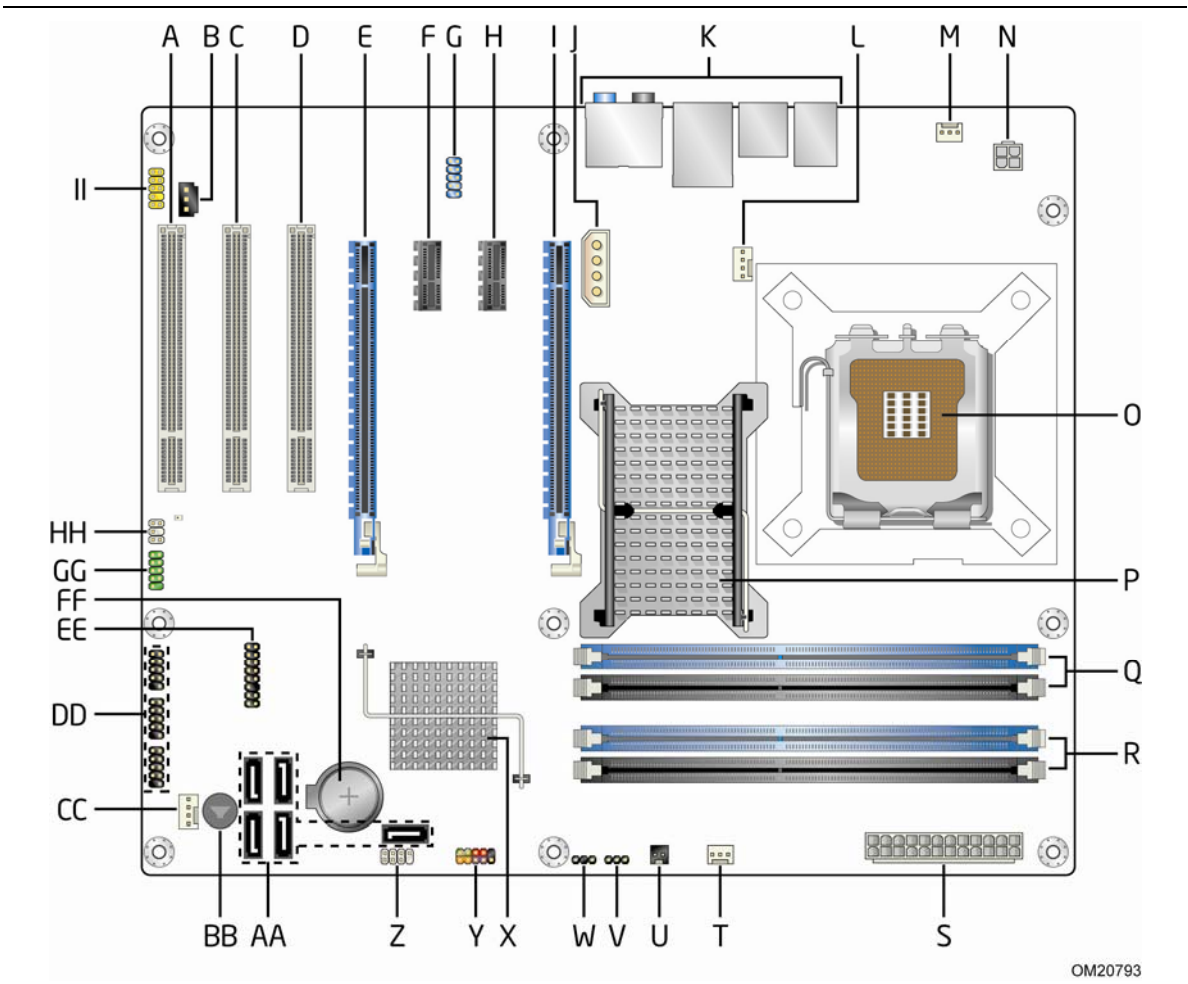

Figure 1. Major Board Components

Table 2 lists the components identified in Figure 1.

Table 2. Components Shown in Figure 1

| Item/callout from Figure 1 | Description |
|-----------------------------------|--------------------------------------------------|
| A | PCI Conventional bus add-in card connector |
| B | S/PDIF connector |
| C | PCI Conventional bus add-in card connector |
| D | PCI Conventional bus add-in card connector |
| E | PCI Express x16 bus add-in card connector |
| F | PCI Express x1 bus add-in card connector |
| G | IEEE 1394a front panel header |
| H | PCI Express x1 bus add-in card connector |
| I | PCI Express x16 us add-in card connector |
| J | Auxiliary PCI Express graphics power |
| K | Back panel connectors |
| L | Processor fan header |
| M | Rear chassis fan header |
| N | Processor core power connector (2 X 2) |
| O | LGA775 processor socket |
| P | Intel 82P45 Memory Controller Hub (MCH) |
| Q | DIMM Channel A sockets [2] |
| R | DIMM Channel B sockets [2] |
| S | Main power connector |
| T | Front chassis fan header |
| U | Chassis intrusion header |
| V | BIOS Setup configuration jumper block |
| W | Auxiliary front panel power LED header |
| X | Intel 82801JR I/O Controller Hub (ICH10R) |
| Y | Front panel header |
| Z | Front panel CIR receiver (input) header |
| AA | Serial ATA connectors [5] |
| BB | Speaker |
| CC | Auxiliary chassis fan header |
| DD | Front panel USB headers [3] |
| EE | High Definition Audio Link header |
| FF | Battery |
| GG | Serial header |
| HH | Back panel CIR emitter (output) header connector |
| II | Front panel audio header |

1.1.3 Block Diagram

Figure 2 is a block diagram of the major functional areas of the board.

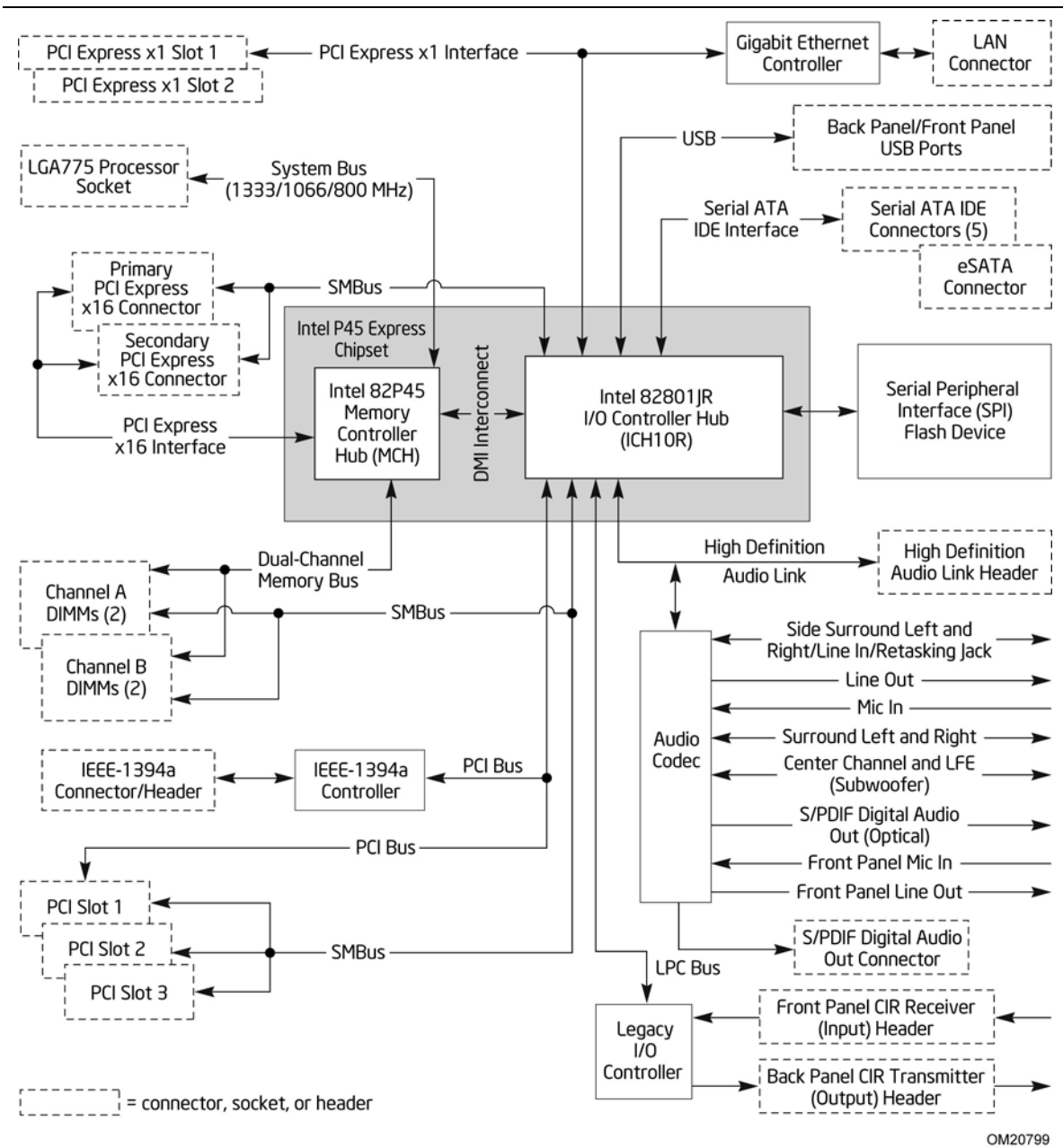

Figure 2. Block Diagram

1.2 Legacy Considerations

This board differs from other Intel Desktop Board products, with specific changes including (but not limited to) the following:

- No parallel port
- No floppy drive connector
- No PS/2 connectors
- No PATA connector

1.3 Online Support

| To find information about... | Visit this World Wide Web site: |
|-------------------------------------------------------------|-----------------------------------------------------------------------------------------------------------------------------------------|
| Intel® Desktop Board DP45SG | http://www.intel.com/products/motherboard/DP45SG/index.htm |
| Desktop Board Support | http://support.intel.com/support/motherboards/desktop/DP45SG |
| Available configurations for the Intel Desktop Board DP45SG | http://www.intel.com/products/motherboard/DP45SG/index.htm |
| Supported processors | http://processormatch.intel.com/ |
| Chipset information | http://www.intel.com/products/desktop/chipsets/index.htm |
| BIOS and driver updates | http://downloadcenter.intel.com |

1.4 Processor

The board is designed to support the following processors:

- Intel Core 2 Extreme Processor in an LGA775 socket
- Intel Core 2 Quad Processor in an LGA775 socket
- Intel Core 2 Duo Processor in an LGA775 socket
- Intel Pentium Dual-Core Processor in an LGA775 socket
- Intel Celeron Dual-Core Processor in an LGA775 socket
- Intel Celeron Processor 400 Sequence in an LGA775 socket

See the Intel web site listed below for the most up-to-date list of supported processors.

| For information about... | Refer to: |
|------------------------------------|---------------------------------------------------------------------------------|
| Supported processors for the board | http://processormatch.intel.com/ |



CAUTION

Use only the processors listed on the web site above. Use of unsupported processors can damage the board, the processor, and the power supply.



INTEGRATOR'S NOTE

This board has specific requirements for providing power to the processor. Refer to Section 2.5.1 on page 53 for information on power supply requirements for this board.

1.5 System Memory

The board has four DIMM sockets and supports the following memory features:

- 1.5 V DDR3 SDRAM DIMMs with gold plated contacts, with the option to raise the voltage to support higher performance DDR3 SDRAM DIMMs
- Dual channel interleaved mode support
Unbuffered, single-sided or double-sided DIMMs.
- 8 GB maximum total system memory. Refer to Section 2.1.1 on page 37 for information on the total amount of addressable memory.
- Minimum recommended total system memory: 256 MB
- Non-ECC DIMMs
- Serial Presence Detect
- DDR3 1333 MHz, DDR3 1066 MHz, and DDR3 800 MHz SDRAM DIMMs



NOTES

- *Remove the video card in the Primary PCI Express x16 before installing or upgrading memory to avoid interference with the memory retention mechanism.*
- *To be fully compliant with all applicable DDR SDRAM memory specifications, the board should be populated with DIMMs that support the Serial Presence Detect (SPD) data structure. This allows the BIOS to read the SPD data and program the chipset to accurately configure memory settings for optimum performance. If non-SPD memory is installed, the BIOS will attempt to correctly configure the memory settings, but performance and reliability may be impacted or the DIMMs may not function under the determined frequency.*

Table 3 lists the supported DIMM configurations.

Table 3. Supported Memory Configurations

| DIMM Capacity | Configuration (Note) | SDRAM Density | SDRAM Organization Front-side/Back-side | Number of SDRAM Devices |
|----------------------|--------------------------------|----------------------|----------------------------------------------------------|--------------------------------|
| 256 MB | SS | 512 Mbit | 32 M x 16/empty | 4 |
| 512 MB | SS | 512 Mbit | 64 M x 8/empty | 8 |
| 512 MB | DS | 512 Mbit | 32 M x 16/32 M x 16 | 8 |
| 512 MB | SS | 1 Gbit | 64 M x 16/empty | 4 |
| 1024 MB | DS | 512 Mbit | 64 M x 8/64 M x 8 | 16 |
| 1024 MB | SS | 1 Gbit | 128 M x 8/empty | 8 |
| 1024 MB | DS | 1 Gbit | 64 M x 16/64 M x 16 | 8 |
| 2048 MB | DS | 1 Gbit | 128 M x 8/128 M x 8 | 16 |

Note: In the second column, "DS" refers to double-sided memory modules (containing two rows of SDRAM) and "SS" refers to single-sided memory modules (containing one row of SDRAM).

For information about...

Tested Memory

Refer to:

<http://support.intel.com/support/motherboards/desktop/sb/CS-025414.htm>

1.5.1 Memory Configurations

The Intel 82P45 MCH supports the following types of memory organization:

- **Dual channel (Interleaved) mode.** This mode offers the highest throughput for real world applications. Dual channel mode is enabled when the installed memory capacities of both DIMM channels are equal. Technology and device width can vary from one channel to the other but the installed memory capacity for each channel must be equal. If different speed DIMMs are used between channels, the slowest memory timing will be used.
- **Single channel (Asymmetric) mode.** This mode is equivalent to single channel bandwidth operation for real world applications. This mode is used when only a single DIMM is installed or the memory capacities are unequal. Technology and device width can vary from one channel to the other. If different speed DIMMs are used between channels, the slowest memory timing will be used.
- **Flex mode.** This mode provides the most flexible performance characteristics. The bottommost DRAM memory (the memory that is lowest within the system memory map) is mapped to dual channel operation; the topmost DRAM memory (the memory that is nearest to the 8 GB address space limit), if any, is mapped to single channel operation. Flex mode results in multiple zones of dual and single channel operation across the whole of DRAM memory. To use flex mode, it is necessary to populate both channels.

For information about...

Memory Configuration Examples

Refer to:

<http://www.intel.com/support/motherboards/desktop/sb/cs-011965.htm>

Figure 3 illustrates the memory channel and DIMM configuration.



NOTE

The DIMM 0 sockets of both channels are blue. The DIMM 1 sockets of both channels are black.

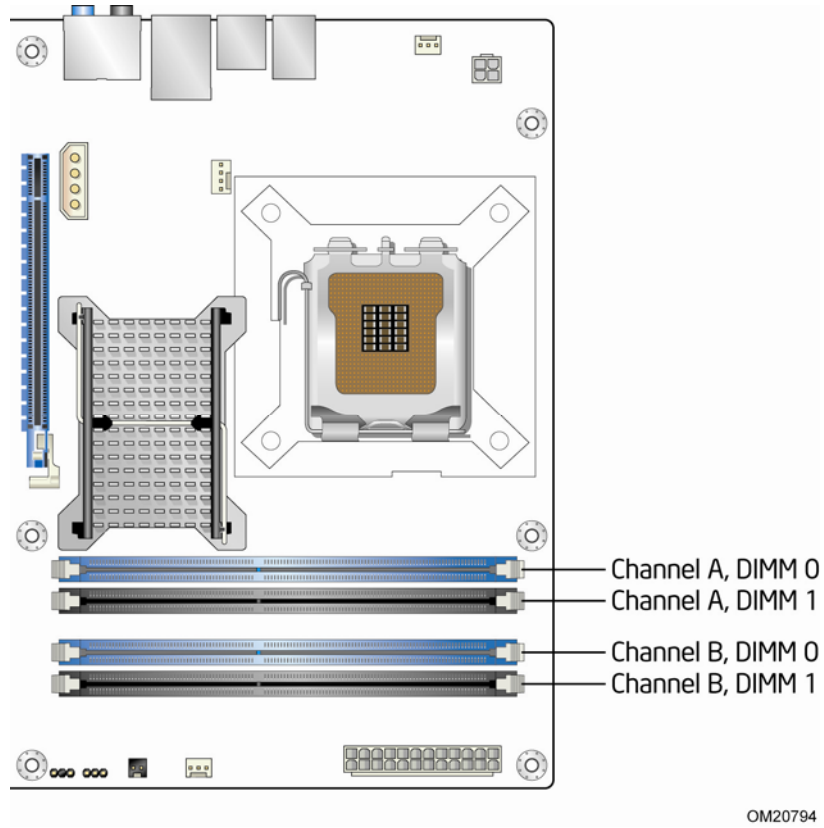

Figure 3. Memory Channel and DIMM Configuration

1.6 Intel® P45 Chipset

The Intel P45 chipset consists of the following devices:

- Intel 82P45 Memory Controller Hub (MCH) with Direct Media Interface (DMI) interconnect
- Intel 82801JR I/O Controller Hub (ICH10R)

The MCH component provides interfaces to the processor, memory, and PCI Express. The ICH10R is a centralized controller for the board's I/O paths.

| For information about | Refer to |
|-------------------------------|---------------------------------------------------------------------------------------------------------------------------------|
| The Intel P45 chipset | http://www.intel.com/products/desktop/chipsets/index.htm |
| Resources used by the chipset | Chapter 2 |

1.6.1 PCI Express x16 Graphics

The MCH supports two add-in discrete graphics card via the PCI Express 2.0 graphics connector:

- One Primary PCI Express 2.0 x16 (electrical x16 or x8) bus add-in card connector. The x16 interface supports simultaneous (full duplex) transfers up to 16 GBytes/sec when operating in x16 mode with a compatible PCI Express 2.0 x16 discrete graphics card. Backwards compatible with PCI Express 1.1 x16, supporting a maximum theoretical bandwidth of 8 GB/s. Interface will operate in x16 mode only if the secondary PCI Express x16 connector is not populated.
- One Secondary PCI Express 2.0 x16 (electrical x8) bus add-in card connector: The board provides a PCI Express add-in card connector in the form of a physical x16 connector with electrical routing of x8. This connector is an electrical equivalent of a PCI Express x8 bus add-in card connector. This connector also supports x4 and x1 PCI Express add-in cards. This interface supports PCI Express 2.0 bandwidth when used with a compatible PCI Express 2.0 x16 discrete graphics card.

| For information about | Refer to |
|------------------------------|-----------------------------------------------------------|
| PCI Express technology | http://www.pcisig.com |

1.6.2 USB

The board supports up to twelve USB 2.0 ports, supports UHCI and EHCI, and uses UHCI- and EHCI-compatible drivers.

The ICH10R provides the USB controller for all ports. The port arrangement is as follows:

- Six ports are implemented with dual stacked back panel connectors adjacent to the audio connectors
- Six ports are routed to three separate front panel USB headers

| For information about | Refer to |
|------------------------------------------------------|--------------------|
| The location of the USB connectors on the back panel | Figure 9, page 40 |
| The location of the front panel USB headers | Figure 10, page 41 |

1.6.3 Serial ATA Interfaces

The board provides five Serial ATA (SATA) connectors, which support one device per connector. The board also provides one red-colored external Serial ATA (eSATA) connector on the back panel.

1.6.3.1 Serial ATA Support

The board's Serial ATA controller offers six independent Serial ATA ports with a theoretical maximum transfer rate of 3 Gbits/sec per port. One device can be installed on each port for a maximum of six Serial ATA devices. A point-to-point interface is used for host to device connections, unlike Parallel ATA IDE which supports a master/slave configuration and two devices per channel.

For compatibility, the underlying Serial ATA functionality is transparent to the operating system. The Serial ATA controller can operate in both legacy and native modes. In legacy mode, standard IDE I/O and IRQ resources are assigned (IRQ 14 and 15). In Native mode, standard PCI Conventional bus resource steering is used. Native mode is the preferred mode for configurations using the Windows* XP and Windows Vista* operating systems.



NOTE

Many Serial ATA drives use new low-voltage power connectors and require adapters or power supplies equipped with low-voltage power connectors.

For more information, see: <http://www.serialata.org/>.

| For information about | Refer to |
|-------------------------------------------|--------------------|
| The location of the Serial ATA connectors | Figure 10, page 41 |

1.6.3.2 Serial ATA RAID

The board supports Intel Matrix Storage Technology which provides the following RAID (Redundant Array of Independent Drives) levels via the ICH10R:

- **RAID 0** - data striping
- **RAID 1** - data mirroring
- **RAID 0+1 (or RAID 10)** - data striping and mirroring
- **RAID 5** - distributed parity



NOTE

In order to use supported RAID features, you must first enable RAID in the BIOS. Also, during Microsoft Windows XP installation, you must press F6 to install the RAID drivers. See your Microsoft Windows XP documentation for more information about installing drivers during installation.

1.6.3.3 Intel® Rapid Recover Technology

The board incorporates the Intel® Rapid Recover Technology (Intel® RRT). Intel® Rapid Recover Technology is a feature of Intel® Matrix Storage Manager. It uses RAID 1 (mirroring) functionality to copy data from a designated master drive to a designated recovery drive. The master drive data can be copied to the recovery drive either continuously or on request.

When using the continuous update policy, changes made to the data on the master drive while the recovery drive is disconnected or offline are automatically copied to the recovery drive when it is reconnected. When using the on request update policy, the master drive data can be restored to a previous state by copying the data on the recovery drive back to the master drive.

For information about

Intel® Matrix Storage and Intel® Rapid Recovery Technology

Refer to

http://www.intel.com/design/chipsets/matrixstorage_sb.htm

1.7 Real-Time Clock Subsystem

A coin-cell battery (CR2032) powers the real-time clock and CMOS memory. When the computer is not plugged into a wall socket, the battery has an estimated life of three years. When the computer is plugged in, the standby current from the power supply extends the life of the battery. The clock is accurate to ± 13 minutes/year at 25 °C with 3.3 VSB applied.



NOTE

If the battery and AC power fail, custom defaults, if previously saved, will be loaded into CMOS RAM at power-on.

When the voltage drops below a certain level, the BIOS Setup program settings stored in CMOS RAM (for example, the date and time) might not be accurate. Replace the battery with an equivalent one. Figure 1 on page 11 shows the location of the battery.

1.8 Legacy I/O Controller

The I/O controller provides the following features:

- Consumer Infrared (CIR) headers
- Serial IRQ interface compatible with serialized IRQ support for PCI systems
- Intelligent power management, including a programmable wake-up event interface
- PCI power management support

The BIOS Setup program provides configuration options for the I/O controller.

1.8.1 Consumer Infrared (CIR)

The Consumer Infrared (CIR) feature is designed to comply with Microsoft Consumer Infrared usage models. Microsoft Windows Vista is the supported operating system.

The CIR feature is made up of two separate pieces: the receiving (receiver) header, and the output (emitter) header. The receiving header consists of a filtered translated infrared input compliant with Microsoft CIR specifications, and also a "learning" infrared input. This learning input is simply a high pass input which the computer can use to "learn" to speak the infrared communication language of other user remotes. The emitter header consists of two output ports which the PC can use to emulate "learned" infrared commands in order to control external electronic hardware.

Customers are required to buy or create their own interface modules to plug into Intel Desktop Boards for this feature to work.

1.9 Audio Subsystem

The onboard audio subsystem consists of the following:

- Intel 82801JR (ICH10R)
- IDT 92HD73E audio codec
- Back panel audio connectors
- Component-side audio headers:
 - Intel® High Definition Audio front panel header
 - HD audio link header
 - S/PDIF connector

The audio subsystem supports the following features:

- Dolby Home Theater support
- A signal-to-noise (S/N) ratio of 95 dB
- Independent multi-streaming 7.1 audio (using the back panel audio connectors) and stereo (using the Intel High Definition Audio front panel header).



NOTE

Systems built with AC 97 front panel will not be able to obtain the Microsoft Windows Vista logo after June 2007.*

Table 4 lists the supported functions of the front panel and back panel audio jacks.

Table 4. Audio Jack Retasking Support

| Audio Jack | Supports Micro- phone? | Supports Line out? | Supports Head- phones? | Supports Line in / Side Surround ? | Supports Rear Surround ? | Supports Center/ Sub- woofer? |
|---------------------|---------------------------|-----------------------|------------------------------|------------------------------------------------|-----------------------------------|----------------------------------------|
| Front panel – Green | No | Yes | Yes | No | No | No |
| Front panel – Pink | Yes | No | No | No | No | No |
| Back panel – Blue | No | No | No | Yes | No | No |
| Back panel – Green | No | Yes | Yes | No | No | No |
| Back panel – Pink | Yes | No | No | No | No | No |
| Back panel – Black | No | No | No | No | Yes | No |
| Back panel – Orange | No | No | No | No | No | Yes |

1.9.1 Audio Subsystem Software

Audio software and drivers are available from Intel's World Wide Web site.

For information about

Obtaining audio software and drivers

Refer to

Section 1.3, page 14

1.9.2 Audio Connectors and Headers

The board contains audio connectors and headers on both the back panel and the component side of the board. The component-side audio connectors include the following:

- Front panel audio (a 2 x 5-pin header that provides mic in and line out signals for front panel audio connectors)
- High Definition (HD) Audio Link header (a 2 x 8-pin header) used for compatible discrete graphic cards supporting HDMI
- S/PDIF audio connector (a 1 x 3-pin header) can be alternately used for discrete graphic cards supporting HDMI that do not have compatibility with the HD Audio Link header

The back panel audio connectors are configurable through the audio device drivers. The available configurable audio ports are shown in Figure 4.

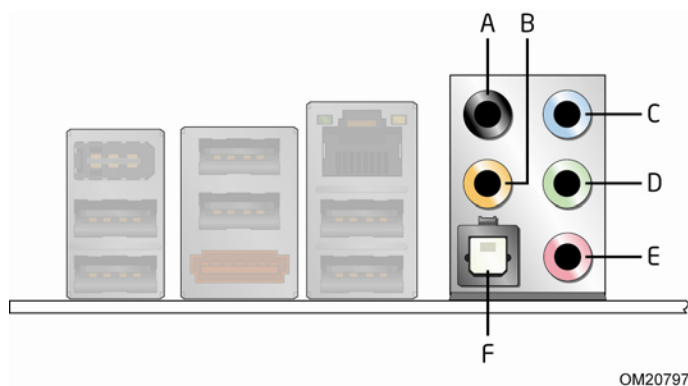

| Item | Description |
|------|----------------------------------------------|
| A | Rear surround left/right channel audio out |
| B | Center channel and LFE (subwoofer) audio out |
| C | Line in / Side surround |
| D | Line out |
| E | Mic in |
| F | S/PDIF Digital Audio Out (Optical) |

Figure 4. Back Panel Audio Connector Options

| For information about | Refer to |
|--------------------------------------------------|------------------------|
| The back panel audio connectors | Section 2.2.1, page 40 |
| The location of the front panel audio header | Figure 1, page 11 |
| The signal names of the front panel audio header | Table 12, page 43 |
| The location of the HD Audio Link header | Figure 1, page 11 |
| The signal names of the HD Audio Link header | Table 11, page 43 |

1.10 LAN Subsystem

The LAN subsystem consists of the following:

- Intel 82567LF Gigabit Ethernet Controller (10/100/1000 Mb/s)
- Intel 82801JR (ICH10R)
- RJ-45 LAN connector with integrated status LEDs

Additional features of the LAN subsystem include:

- CSMA/CD protocol engine
- LAN connect interface between ICH10R and the LAN controller
- PCI Conventional bus power management
 - ACPI technology support
 - LAN wake capabilities
- LAN subsystem software

For information about

LAN software and drivers

Refer to

<http://downloadcenter.intel.com>

1.10.1 Intel® 82567LF Gigabit Ethernet Controller

The Intel 82567LF Gigabit Ethernet Controller supports the following features:

- PCI Express link
- 10/100/1000 IEEE 802.3 compliant
- Compliant to IEEE 802.3x flow control support
- 802.1p and 802.1q
- TCP, IP, and UDP checksum offload (for IPv4 and IPv6)
- Transmit TCP segmentation
- Full device driver compatibility
- PCI Express power management support

1.10.2 LAN Subsystem Software

LAN software and drivers are available from Intel’s World Wide Web site.

For information about

Refer to

Obtaining LAN software and drivers

<http://downloadcenter.intel.com>

1.10.3 RJ-45 LAN Connector with Integrated LEDs

Two LEDs are built into the RJ-45 LAN connector (shown in Figure 5 below).

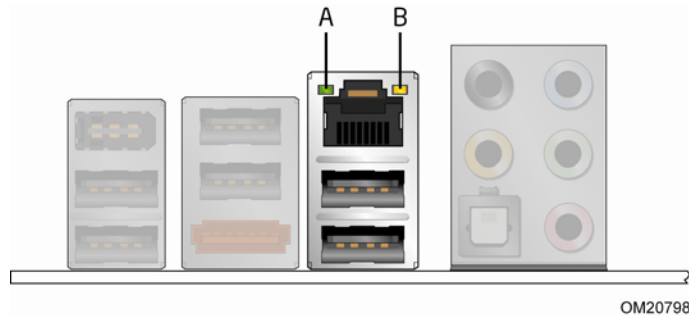

| Item | Description |
|------|------------------------------|
| A | Link LED (Green) |
| B | Data Rate LED (Green/Yellow) |

Figure 5. LAN Connector LED Locations

Table 5 describes the LED states when the board is powered up and the LAN subsystem is operating.

Table 5. LAN Connector LED States

| LED | LED Color | LED State | Condition |
|-----------|--------------|-----------|---------------------------------------|
| Link | Green | Off | LAN link is not established. |
| | | On | LAN link is established. |
| | | Blinking | LAN activity is occurring |
| Data Rate | Green/Yellow | Off | 10 Mbits/sec data rate is selected. |
| | | Green | 100 Mbits/sec data rate is selected. |
| | | Yellow | 1000 Mbits/sec data rate is selected. |

1.11 Hardware Management Subsystem

The hardware management features enable the board to be compatible with the Wired for Management (WfM) specification. The board has several hardware management features, including the following:

- Fan monitoring and control
- Thermal and voltage monitoring
- Chassis intrusion detection

1.11.1 Hardware Monitoring and Fan Control

The features of the hardware monitoring and fan control include:

- Fan speed control controllers and sensors provided by the Hardware Monitoring and Fan Control ASIC
- Thermal sensors in the processor, 82P45 MCH, 82801JR ICH10R, and remote thermal sensors
- Power supply monitoring of five voltages (+5 V, +12 V, +3.3 V, +1.125 V, and +VCCP) to detect levels above or below acceptable values
- Thermally monitored closed-loop fan control, for all four fans, that can adjust the fan speed according to thermal conditions

1.11.2 Fan Monitoring

Fan monitoring can be implemented using Intel® Desktop Control Center or third-party software.

| For information about | Refer to |
|----------------------------------|---------------------------|
| The functions of the fan headers | Section 1.12.2.2, page 33 |

1.11.3 Chassis Intrusion and Detection

The board supports a chassis security feature that detects if the chassis cover is removed. The security feature uses a mechanical switch on the chassis that attaches to the chassis intrusion header. When the chassis cover is removed, the mechanical switch is in the closed position.

| For information about | Refer to |
|----------------------------------------------|--------------------|
| The location of the chassis intrusion header | Figure 10, page 41 |

1.11.4 Thermal Monitoring

Figure 6 shows the locations of the thermal sensors and fan headers.

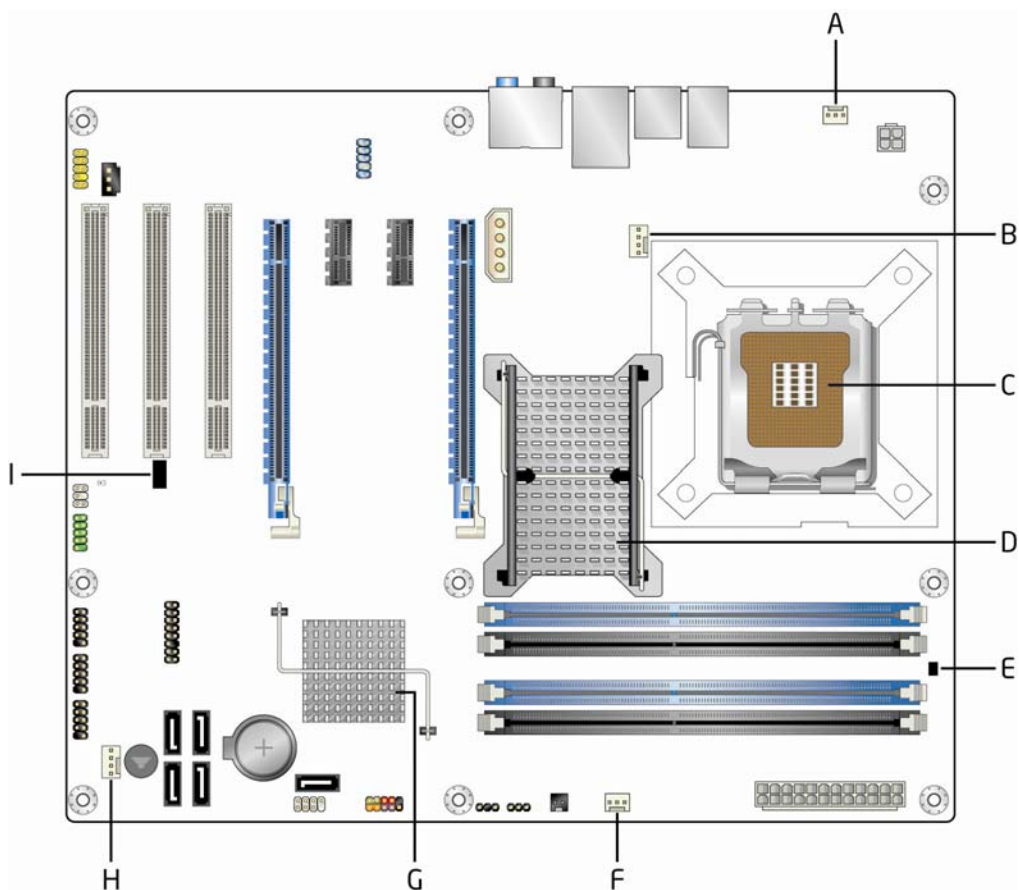

OM20800

| Item | Description |
|------|------------------------------------------|
| A | Rear chassis fan |
| B | Processor fan |
| C | Thermal diode, located on processor die |
| D | Thermal diode, located on the MCH die |
| E | Remote thermal diode |
| F | Front chassis fan |
| G | Thermal diode, located on the ICH10R die |
| H | Auxiliary chassis fan |
| I | Hardware monitoring and fan control ASIC |

Figure 6. Thermal Sensors and Fan Headers



NOTE

The minimum thermal reporting threshold for the MCH is 66 °C. The MCH thermal sensor will display 66 °C until the temperature rises above this point.

1.12 Power Management

Power management is implemented at several levels, including:

- Software support through Advanced Configuration and Power Interface (ACPI)
- Hardware support:
 - Power connector
 - Fan headers
 - LAN wake capabilities
 - Instantly Available PC technology
 - Wake from USB
 - Power Management Event signal (PME#) wake-up support
 - PCI Express WAKE# signal support

1.12.1 ACPI

ACPI gives the operating system direct control over the power management and Plug and Play functions of a computer. The use of ACPI with this board requires an operating system that provides full ACPI support. ACPI features include:

- Plug and Play (including bus and device enumeration)
- Power management control of individual devices, add-in boards (some add-in boards may require an ACPI-aware driver), video displays, and hard disk drives
- Methods for achieving less than 15-watt system operation in the power-on/standby sleeping state
- A Soft-off feature that enables the operating system to power-off the computer
- Support for multiple wake-up events (see Table 8 on page 32)
- Support for a front panel power and sleep mode switch

Table 6 lists the system states based on how long the power switch is pressed, depending on how ACPI is configured with an ACPI-aware operating system.

Table 6. Effects of Pressing the Power Switch

| If the system is in this state... | ...and the power switch is pressed for | ...the system enters this state |
|------------------------------------------|-----------------------------------------------|------------------------------------------------|
| Off (ACPI G2/G5 – Soft off) | Less than four seconds | Power-on (ACPI G0 – working state) |
| On (ACPI G0 – working state) | Less than four seconds | Soft-off/Standby (ACPI G1 – sleeping state) |
| On (ACPI G0 – working state) | More than six seconds | Fail safe power-off (ACPI G2/G5 – Soft off) |
| Sleep (ACPI G1 – sleeping state) | Less than four seconds | Wake-up (ACPI G0 – working state) |
| Sleep (ACPI G1 – sleeping state) | More than six seconds | Power-off (ACPI G2/G5 – Soft off) |

1.12.1.1 System States and Power States

Under ACPI, the operating system directs all system and device power state transitions. The operating system puts devices in and out of low-power states based on user preferences and knowledge of how devices are being used by applications. Devices that are not being used can be turned off. The operating system uses information from applications and user settings to put the system as a whole into a low-power state.

Table 7 lists the power states supported by the board along with the associated system power targets. See the ACPI specification for a complete description of the various system and power states.

Table 7. Power States and Targeted System Power

| Global States | Sleeping States | Processor States | Device States | Targeted System Power (Note 1) |
|--------------------------------------------------------------------|----------------------------------------------------------|-------------------------|--------------------------------------------------------------------------------------|----------------------------------------------------------|
| G0 – working state | S0 – working | C0 – working | D0 – working state. | Full power > 30 W |
| G1 – sleeping state | S1 – Processor stopped | C1 – stop grant | D1, D2, D3 – device specification specific. | 5 W < power < 52.5 W |
| G1 – sleeping state | S3 – Suspend to RAM. Context saved to RAM. | No power | D3 – no power except for wake-up logic. | Power < 5 W (Note 2) |
| G1 – sleeping state | S4 – Suspend to disk. Context saved to disk. | No power | D3 – no power except for wake-up logic. | Power < 5 W (Note 2) |
| G2/S5 | S5 – Soft off. Context not saved. Cold boot is required. | No power | D3 – no power except for wake-up logic. | Power < 5 W (Note 2) |
| G3 – mechanical off AC power is disconnected from the computer. | No power to the system. | No power | D3 – no power for wake-up logic, except when provided by battery or external source. | No power to the system. Service can be performed safely. |

Notes:

1. Total system power is dependent on the system configuration, including add-in boards and peripherals powered by the system chassis' power supply.
2. Dependent on the standby power consumption of wake-up devices used in the system.

1.12.1.2 Wake-up Devices and Events

Table 8 lists the devices or specific events that can wake the computer from specific states.

Table 8. Wake-up Devices and Events

| These devices/events can wake up the computer... | ...from this state |
|--------------------------------------------------|----------------------------------------|
| LAN | S1, S3, S4, S5 ^(Note 1) |
| PME# signal | S1, S3, S4, S5 ^(Note 1) |
| Power switch | S1, S3, S4, S5 |
| RTC alarm | S1, S3, S4, S5 |
| USB | S1, S3 |
| WAKE# | S1, S3, S4, S5 |
| Consumer IR | S1, S3 (S4 and S5) ^(Note 2) |

Note 1: For LAN and PME# signal, S5 is disabled by default in the BIOS Setup program. Setting this option to Power On will enable a wake-up event from LAN in the S5 state.

Note 2: Wake from S4 and S5 is optional by the specification.



NOTE

The use of these wake-up events from an ACPI state requires an operating system that provides full ACPI support. In addition, software, drivers, and peripherals must fully support ACPI wake events.

1.12.2 Hardware Support



CAUTION

Ensure that the power supply provides adequate +5 V standby current if LAN wake capabilities and Instantly Available PC technology features are used. Failure to do so can damage the power supply. The total amount of standby current required depends on the wake devices supported and manufacturing options.

The board provides several power management hardware features, including:

- Power connector
- Fan headers
- LAN wake capabilities
- Instantly Available PC technology
- Wake from USB
- PME# signal wake-up support
- WAKE# signal wake-up support
- Wake from Consumer IR

LAN wake capabilities and Instantly Available PC technology require power from the +5 V standby line.

**NOTE**

The use of Wake from USB from an ACPI state requires an operating system that provides full ACPI support.

1.12.2.1 Power Connector

ATX12V-compliant power supplies can turn off the system power through system control. When an ACPI-enabled system receives the correct command, the power supply removes all non-standby voltages.

When resuming from an AC power failure, the computer returns to the power state it was in before power was interrupted (on or off). The computer's response can be set using the Last Power State feature in the BIOS Setup program's Boot menu.

| For information about | Refer to |
|----------------------------------------------|--------------------|
| The location of the main power connector | Figure 10, page 41 |
| The signal names of the main power connector | Table 21, page 47 |

1.12.2.2 Fan Headers

The function/operation of the fan headers is as follows:

- The fans are on when the board is in the S0 state.
- The fans are off when the board is off or in the S3, S4, or S5 state.
- The processor fan header is wired to a fan tachometer input. The front and rear fan headers each have independent tachometer input to the hardware monitoring and fan control device. All fan headers support closed-loop fan control that can adjust the fan speed according to thermal conditions.
- All fan headers have a +12 V DC connection.

| For information about | Refer to |
|--------------------------------------------------------------------|--------------------|
| The location of the fan headers | Figure 10, page 41 |
| The location of the fan headers and sensors for thermal monitoring | Figure 6, page 28 |
| The signal names of the fan headers | Section 0, page 40 |

1.12.2.3 LAN Wake Capabilities



CAUTION

For LAN wake capabilities, the +5 V standby line for the power supply must be capable of providing adequate +5 V standby current. Failure to provide adequate standby current when implementing LAN wake capabilities can damage the power supply.

LAN wake capabilities enable remote wake-up of the computer through a network. The LAN subsystem PCI bus network adapter monitors network traffic at the Media Independent Interface. Upon detecting a Magic Packet* frame, the LAN subsystem asserts a wake-up signal that powers up the computer. Depending on the LAN implementation, the board supports LAN wake capabilities with ACPI in the following ways:

- The PCI Express WAKE# signal
- The PCI bus PME# signal for PCI 2.3 compliant LAN designs
 - By Ping
 - Magic Packet
- The onboard LAN subsystem

1.12.2.4 Instantly Available PC Technology



CAUTION

For Instantly Available PC technology, the +5 V standby line for the power supply must be capable of providing adequate +5 V standby current. Failure to provide adequate standby current when implementing Instantly Available PC technology can damage the power supply.

Instantly Available PC technology enables the board to enter the ACPI S3 (Suspend-to-RAM) sleep-state. While in the S3 sleep-state, the computer will appear to be off (the power supply is off, and the front panel LED is amber if dual colored, or off if single colored.) When signaled by a wake-up device or event, the system quickly returns to its last known wake state. Table 8 on page 32 lists the devices and events that can wake the computer from the S3 state.

The board supports the *PCI Bus Power Management Interface Specification*. Add-in boards that also support this specification can participate in power management and can be used to wake the computer.

The use of Instantly Available PC technology requires operating system support and PCI 2.2 compliant add-in cards, PCI Express add-in cards, and drivers.

1.12.2.5 Wake from USB

USB bus activity wakes the computer from ACPI S1 or S3 states.



NOTE

Wake from USB requires the use of a USB peripheral that supports Wake from USB.

1.12.2.6 Wake from CIR

Consumer IR activity wakes the computer from ACPI S1 and S3 state, and optionally from the ACPI S4 and S5 state.

1.12.2.7 PME# Signal Wake-up Support

When the PME# signal on the PCI Conventional bus is asserted, the computer wakes from an ACPI S1, S3, S4, or S5 state (with Wake on PME enabled in the BIOS).

1.12.2.8 WAKE# Signal Wake-up Support

When the WAKE# signal on the PCI Express bus is asserted, the computer wakes from an ACPI S1, S3, S4, or S5 state.

1.12.2.9 +5 V Standby Power Indicator LED and Additional LEDs

The +5 V standby power indicator LED shows that power is still present even when the computer appears to be off. Figure 7 shows the location of the standby power indicator LED on the board.



CAUTION

If AC power has been switched off and the standby power indicators are still lit, disconnect the power cord before installing or removing any devices connected to the board. Failure to do so could damage the board and any attached devices.

In addition to the standby power indicator, the board contains two LEDs that indicate the following:

- The Processor LED indicates an elevated temperature on the processor that could effect performance
- The Voltage Regulator LED indicates an elevated temperature in the processor voltage regulator circuit that could effect performance

Figure 7 shows the location of these additional LEDs.

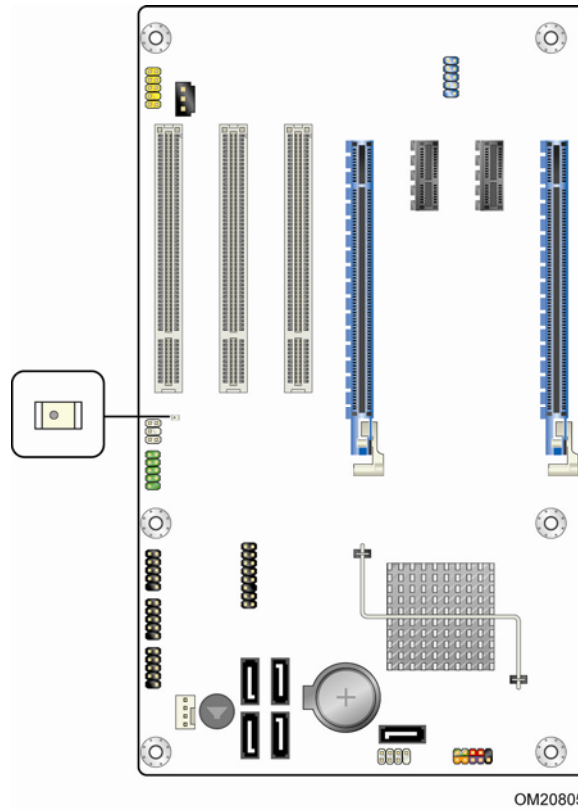

Figure 7. Location of the Standby Power Indicator LED

1.12.3 ENERGY STAR*

In 2007, the US Department of Energy and the US Environmental Protection Agency revised the ENERGY STAR* requirements. Intel has worked directly with these two governmental agencies to define the new requirements. Currently this Intel Desktop Board meets the new Category C requirements.

For information about

ENERGY STAR requirements and recommended configurations

Refer to

<http://www.intel.com/go/energystar>

2 Technical Reference

2.1 Memory Resources

2.1.1 Addressable Memory

The board utilizes 8 GB of addressable system memory. Typically the address space that is allocated for PCI Conventional bus add-in cards, PCI Express configuration space, BIOS (SPI Flash device), and chipset overhead resides above the top of DRAM (total system memory). On a system that has 8 GB of system memory installed, it is not possible to use all of the installed memory due to system address space being allocated for other system critical functions. These functions include the following:

- BIOS/SPI Flash device (32 Mbit)
- Local APIC (19 MB)
- Direct Media Interface (40 MB)
- Front side bus interrupts (17 MB)
- PCI Express configuration space (256 MB)
- MCH base address registers PCI Express ports (up to 256 MB)
- Memory-mapped I/O that is dynamically allocated for PCI Conventional and PCI Express add-in cards (256 MB)

The board provides the capability to reclaim the physical memory overlapped by the memory mapped I/O logical address space. The board remaps physical memory from the top of usable DRAM boundary to the 4 GB boundary to an equivalent sized logical address range located just above the 4 GB boundary. Figure 8 shows a schematic of the system memory map. All installed system memory can be used when there is no overlap of system addresses.

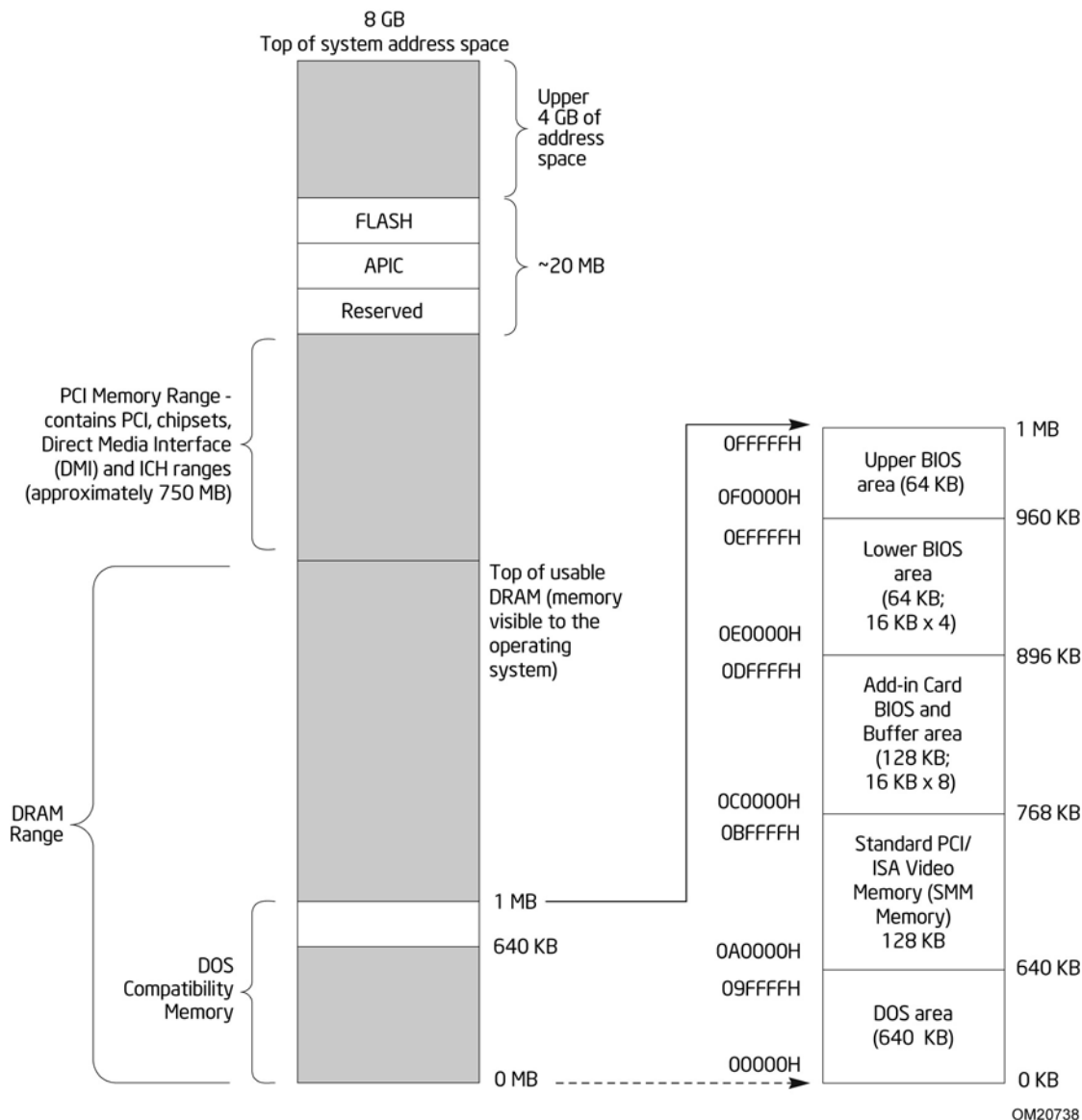

Figure 8. Detailed System Memory Address Map

2.1.2 Memory Map

Table 9 lists the system memory map.

Table 9. System Memory Map

| Address Range (decimal) | Address Range (hex) | Size | Description |
|-------------------------|---------------------|---------|----------------------------------------------------------------------------------------------------------|
| 1024 K - 8388608 K | 100000 - 1FFFFFFF | 8191 MB | Extended memory |
| 960 K - 1024 K | F0000 - FFFFF | 64 KB | Runtime BIOS |
| 896 K - 960 K | E0000 - EFFFF | 64 KB | Reserved |
| 800 K - 896 K | C8000 - DFFFF | 96 KB | Potential available high DOS memory (open to the PCI Conventional bus). Dependent on video adapter used. |
| 640 K - 800 K | A0000 - C7FFF | 160 KB | Video memory and BIOS |
| 639 K - 640 K | 9FC00 - 9FFFF | 1 KB | Extended BIOS data (movable by memory manager software) |
| 512 K - 639 K | 80000 - 9FBFF | 127 KB | Extended conventional memory |
| 0 K - 512 K | 00000 - 7FFFF | 512 KB | Conventional memory |

2.2 Connectors and Headers



CAUTION

Only the following connectors and headers have overcurrent protection: back panel and front panel USB, as well as IEEE 1394.

The other internal connectors and headers are not overcurrent protected and should connect only to devices inside the computer's chassis, such as fans and internal peripherals. Do not use these connectors or headers to power devices external to the computer's chassis. A fault in the load presented by the external devices could cause damage to the computer, the power cable, and the external devices themselves.

Furthermore, improper connection of USB or 1394 header single wire connectors may eventually overload the overcurrent protection and cause damage to the board.

This section describes the board's connectors. The connectors can be divided into these groups:

- Back panel I/O connectors
- Component-side I/O connectors and headers (see page 41)

2.2.1 Back Panel Connectors

Figure 9 shows the location of the back panel connectors for the Intel Desktop Board DP45SG.

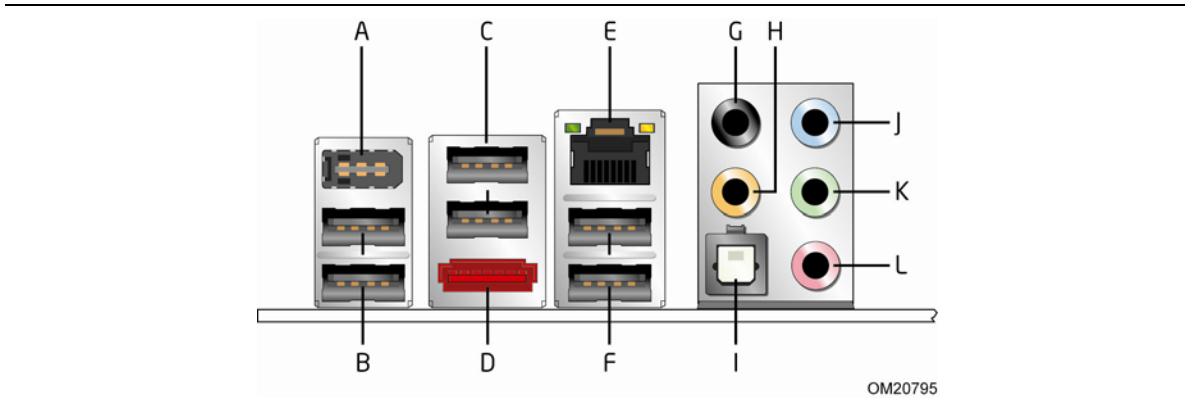

| Item | Description |
|------|----------------------------------------------------------------|
| A | IEEE-1394a connector |
| B | USB ports [2] |
| C | USB ports [2] |
| D | eSATA port |
| E | LAN |
| F | USB ports [2] |
| G | Center channel and LFE (subwoofer) audio out/ Retasking Jack G |
| H | Rear surround left/right channel audio out |
| I | Digital audio out optical |
| J | Audio line in/Side surround left/right channel audio out |
| K | Front left/right channel audio out |
| L | Mic in |

Figure 9. Back Panel Connectors



NOTE

The back panel audio line out connector is designed to power headphones or amplified speakers only. Poor audio quality occurs if passive (non-amplified) speakers are connected to this output.

2.2.2 Component-side Connectors and Headers

Figure 10 shows the locations of the component-side connectors and headers.

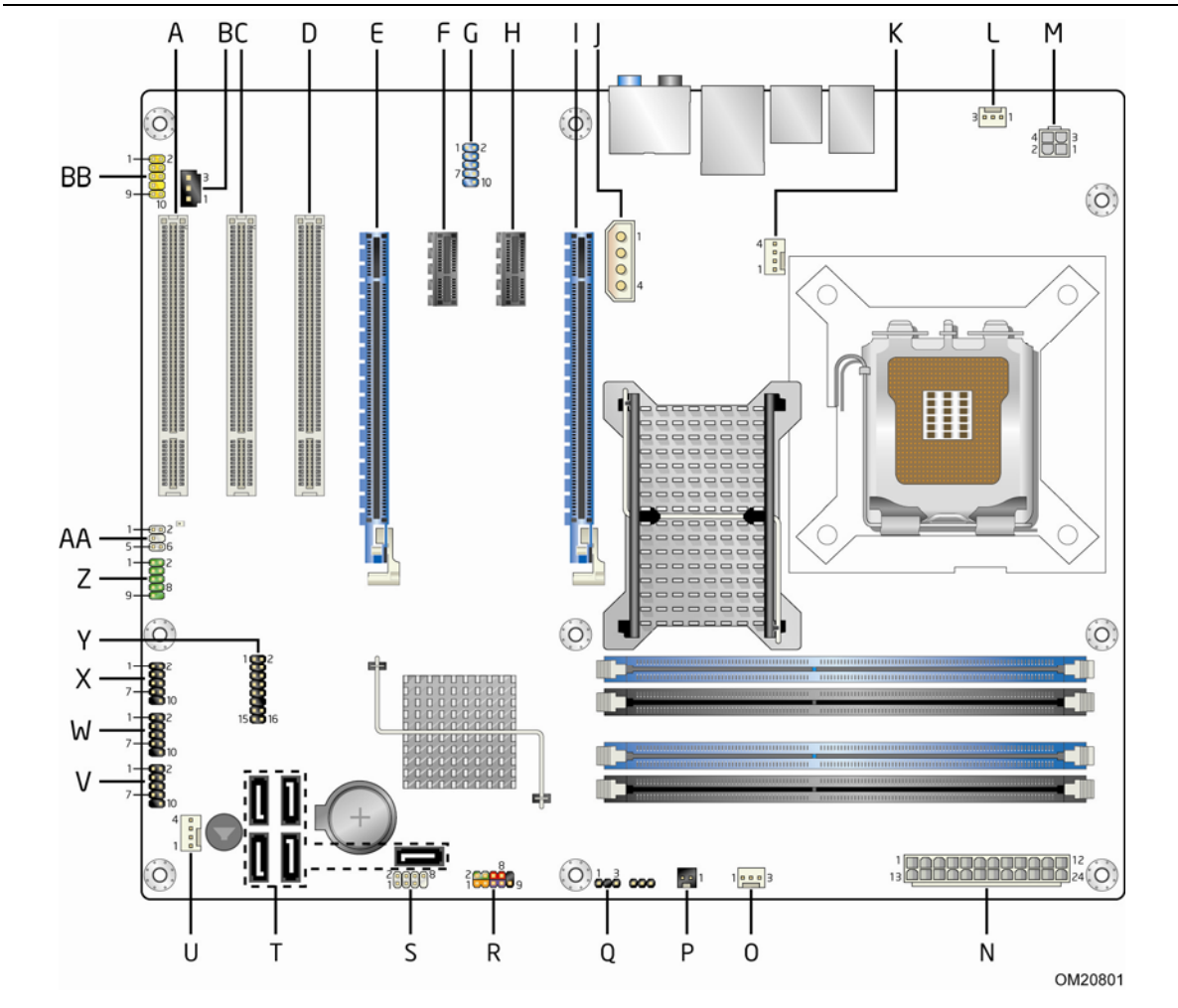

Figure 10. Component-side Connectors and Headers

Table 10 lists the component-side connectors and headers identified in Figure 10.

Table 10. Component-side Connectors and Headers Shown in Figure 10

| Item/callout from Figure 10 | Description |
|------------------------------------|--------------------------------------------------|
| A | PCI Conventional bus add-in card connector |
| B | S/PDIF connector |
| C | PCI Conventional bus add-in card connector |
| D | PCI Conventional bus add-in card connector |
| E | PCI Express x16 bus add-in card connector |
| F | PCI Express x1 bus add-in card connector |
| G | IEEE 1394a front panel header |
| H | PCI Express x1 bus add-in card connector |
| I | PCI Express x16 bus add-in card connector |
| J | Auxiliary PCI Express graphics power |
| K | Processor fan header |
| L | Rear chassis fan header |
| M | Processor core power connector (2 X 2) |
| N | Main power connector |
| O | Front chassis fan header |
| P | Chassis intrusion header |
| Q | Auxiliary front panel power LED header |
| R | Front panel header |
| S | Front panel CIR receiver (input) header |
| T | Serial ATA connectors [5] |
| U | Auxiliary chassis fan header |
| V | Front panel USB header |
| W | Front panel USB header |
| X | Front panel USB header |
| Y | High Definition Audio Link header |
| Z | Serial header |
| AA | Back panel CIR emitter (output) header connector |
| BB | Front panel audio header |

2.2.2.1 Signal Tables for the Connectors and Headers

Table 11. HD Audio Link Header

| Pin | Signal Name | Pin | Signal Name |
|-----|---------------|-----|-----------------|
| 1 | BCLK | 2 | Ground |
| 3 | RST# | 4 | DVDD IO |
| 5 | SYNC | 6 | Ground |
| 7 | SDO | 8 | 3.3 V DVDD CORE |
| 9 | SDI0 | 10 | +12 V |
| 11 | SDI1 | 12 | Key (no pin) |
| 13 | Not connected | 14 | 3.3 V DUAL |
| 15 | Not connected | 16 | Ground |

Table 12. Front Panel Audio Header

| Pin | Signal Name | Pin | Signal Name |
|-----|-----------------------------|-----|----------------------------|
| 1 | [Port 1] Left channel | 2 | Ground |
| 3 | [Port 1] Right channel | 4 | PRESENCE# (Dongle present) |
| 5 | [Port 2] Right channel | 6 | [Port 1] SENSE_RETURN |
| 7 | SENSE_SEND (Jack detection) | 8 | Key (no pin) |
| 9 | [Port 2] Left channel | 10 | [Port 2] SENSE_RETURN |

Table 13. Serial ATA Connectors

| Pin | Signal Name |
|-----|-------------|
| 1 | Ground |
| 2 | TXP |
| 3 | TXN |
| 4 | Ground |
| 5 | RXN |
| 6 | RXP |
| 7 | Ground |

Table 14. Serial Port Header

| Pin | Signal Name | Pin | Signal Name |
|-----|---------------------------|-----|---------------------------|
| 1 | DCD (Data Carrier Detect) | 2 | RXD# (Receive Data) |
| 3 | TXD# (Transmit Data) | 4 | DTR (Data Terminal Ready) |
| 5 | Ground | 6 | DSR (Data Set Ready) |
| 7 | RTS (Request to Send) | 8 | CTS (Clear to Send) |
| 9 | RI (Ring Indicator) | 10 | Key (no pin) |

Table 15. Chassis Intrusion Header

| Pin | Signal Name |
|-----|-------------|
| 1 | Intruder |
| 2 | Ground |

Table 16. Front and Rear Chassis (3-Pin) Fan Headers

| Pin | Signal Name |
|-----|----------------|
| 1 | Control (Note) |
| 2 | +12 V |
| 3 | Tach |

Note: These fan headers use voltage variance control for fan speed.

Table 17. Processor and Rear Chassis 2 (4-Pin) Fan Headers

| Pin | Signal Name |
|-----|---------------|
| 1 | Ground (Note) |
| 2 | +12 V |
| 3 | FAN_TACH |
| 4 | FAN_CONTROL |

Note: These fan headers use Pulse Width Modulation control for fan speed.

Table 20. Back Panel CIR Emitter (Output) Header

| Pin | Signal Name |
|-----|---------------|
| 1 | Emitter out 1 |
| 2 | Emitter out 2 |
| 3 | Ground |
| 4 | Key (no pin) |
| 5 | Jack detect 1 |
| 6 | Jack detect 2 |

Table 21. Front Panel CIR Receiver (Input) Header

| Pin | Signal Name |
|-----|--------------|
| 1 | Ground |
| 2 | LED |
| 3 | NC |
| 4 | Learn-in |
| 5 | 5 V standby |
| 6 | VCC |
| 7 | Key (no pin) |
| 8 | CIR Input |

Table 18. S/PDIF Connector

| Pin | Signal Name |
|-----|-------------|
| 1 | VCC |
| 2 | S/PDIF out |
| 3 | Ground |

2.2.2.2 Add-in Card Connectors

The board has the following add-in card connectors:

- PCI Express 2.0 x16: two PCI Express 2.0 x16 connectors
 - Supports PCI Express GEN1 frequency of 1.25 GHz resulting in 2.5 Gb/s each direction (500 MB/s total). Maximum theoretical bandwidth on interface of 4 GB/s in each direction simultaneously, for an aggregate of 8 GB/s when operating in x16 mode.
 - Supports PCI Express GEN2 frequency of 2.5 GHz resulting in 5.0 Gb/s each direction (1000 MB/s total). Maximum theoretical bandwidth on interface of 8 GB/s in each direction simultaneously, for an aggregate of 16 GB/s when operating in x16 mode.

NOTE

If both PCI Express x16 slots are populated, the effective bandwidth will be at x8 for each slot. Both cards must be PCI Express 2.0 compatible to achieve PCI Express 2.0 bandwidth.

- PCI Express x1: two PCI Express x1 connectors.
 - The x1 interface supports simultaneous transfer speeds up to 250 Mbytes/sec of peak bandwidth per direction and up to 500 MBytes/sec concurrent bandwidth.
- PCI Conventional (rev 2.3 compliant) bus: three PCI Conventional bus add-in card connectors.
 - The SMBus is routed to all PCI Conventional bus connectors. PCI Conventional bus add-in cards with SMBus support can access sensor data and other information residing on the board.

Note the following considerations for the PCI Conventional bus connectors:

- All of the PCI Conventional bus connectors are bus master capable.
- SMBus signals are routed to all PCI Conventional bus connectors. This enables PCI Conventional bus add-in boards with SMBus support to access sensor data on the board. The specific SMBus signals are as follows:
 - The SMBus clock line is connected to pin A40.
 - The SMBus data line is connected to pin A41.

2.2.2.3 Auxiliary Front Panel Power/Sleep LED Header

Pins 1 and 3 of this header duplicate the signals on pins 2 and 4 of the front panel header.

Table 19. Auxiliary Front Panel Power/Sleep LED Header

| Pin | Signal Name | In/Out | Description |
|-----|---------------|--------|------------------------|
| 1 | HDR_BLNK_GRN | Out | Front panel green LED |
| 2 | Not connected | | |
| 3 | HDR_BLNK_YEL | Out | Front panel yellow LED |

2.2.2.4 Power Supply Connectors

The board has the following power supply connectors:

- **Main power** – a 2 x 12 connector. This connector is compatible with 2 x 10 connectors previously used on Intel Desktop boards. The board supports the use of ATX12V power supplies with either 2 x 10 or 2 x 12 main power cables. When using a power supply with a 2 x 10 main power cable, attach that cable on the rightmost pins of the main power connector, leaving pins 11, 12, 23, and 24 unconnected.
- **Processor core power** – a 2 x 2 connector. This connector provides power directly to the processor voltage regulator and must always be used. Failure to do so will prevent the board from booting.
- **Auxiliary PCI Express graphics power** – a 1 x 4 connector. This connector provides the required additional power when using high power (75 W or greater) add-in cards in either of the PCI Express x16 bus add-in card connectors. See Figure 1 for location.



CAUTION

If high power (75 W or greater) add-in cards are installed in either of the PCI Express x16 bus add-in card connectors, the Auxiliary PCI Express graphics power connector must be used. Failure to do so may cause damage to the board and the add-in cards. Furthermore, if you use a 2 X 10 power cable, you must also use the Auxiliary PCI Express graphics power connector to ensure stable board operation.

Table 20. Processor Core Power Connector

| Pin | Signal Name | Pin | Signal Name |
|-----|-------------|-----|-------------|
| 1 | Ground | 2 | Ground |
| 3 | +12 V | 4 | +12 V |

Table 21. Main Power Connector

| Pin | Signal Name | Pin | Signal Name |
|-----|--------------------------------|-----|-------------------------------------|
| 1 | +3.3 V | 13 | +3.3 V |
| 2 | +3.3 V | 14 | -12 V |
| 3 | Ground | 15 | Ground |
| 4 | +5 V | 16 | PS-ON# (power supply remote on/off) |
| 5 | Ground | 17 | Ground |
| 6 | +5 V | 18 | Ground |
| 7 | Ground | 19 | Ground |
| 8 | PWRGD (Power Good) | 20 | No connect |
| 9 | +5 V (Standby) | 21 | +5 V |
| 10 | +12 V | 22 | +5 V |
| 11 | +12 V (Note) | 23 | +5 V (Note) |
| 12 | 2 x 12 connector detect (Note) | 24 | Ground (Note) |

Note: When using a 2 x 10 power supply cable, this pin will be unconnected.

Table 22. Auxiliary PCI Express Graphics Power

| Pin | Signal Name |
|-----|------------------------|
| 1 | +12 V |
| 2 | 1 x 4 connector detect |
| 3 | Ground |
| 4 | +5 V |

For information about

Power supply considerations

Refer to

Section 2.5.1 on page 53

2.2.2.5 Front Panel Header

This section describes the functions of the front panel header. Table 23 lists the signal names of the front panel header. Figure 11 is a connection diagram for the front panel header.

Table 23. Front Panel Header

| Pin | Signal | In/Out | Description | Pin | Signal | In/Out | Description |
|--------------------------------|-----------|--------|-------------------------------|----------------------|--------------|--------|------------------------|
| Hard Drive Activity LED | | | | Power LED | | | |
| 1 | HD_PWR | Out | Hard disk LED pull-up to +5 V | 2 | HDR_BLNK_GRN | Out | Front panel green LED |
| 3 | HDA# | Out | Hard disk active LED | 4 | HDR_BLNK_YEL | Out | Front panel yellow LED |
| Reset Switch | | | | On/Off Switch | | | |
| 5 | Ground | | Ground | 6 | FPBUT_IN | In | Power switch |
| 7 | FP_RESET# | In | Reset switch | 8 | Ground | | Ground |
| Power | | | | Not Connected | | | |
| 9 | +5 V | | Power | 10 | N/C | | Not connected |

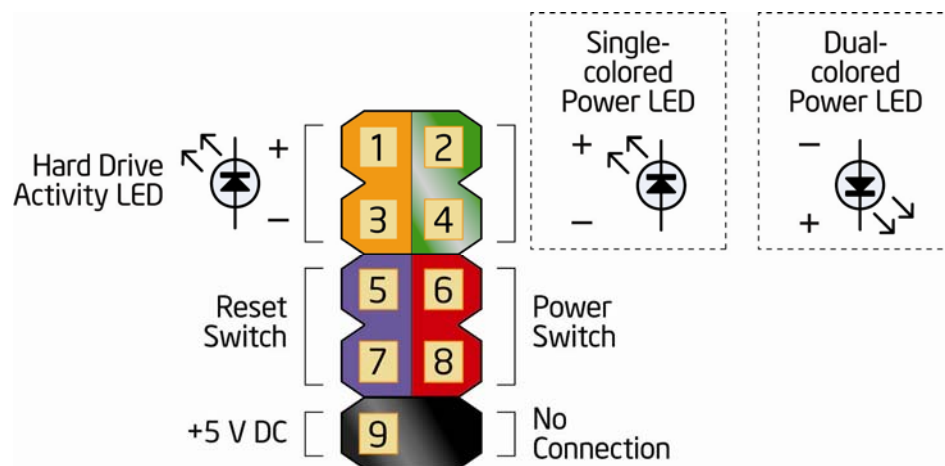

OM20472

Figure 11. Connection Diagram for Front Panel Header

2.2.2.5.1 Hard Drive Activity LED Header

Pins 1 and 3 can be connected to an LED to provide a visual indicator that data is being read from or written to a hard drive. Proper LED function requires one of the following:

- A Serial ATA hard drive or optical drive connected to an onboard Serial ATA connector

- A Parallel ATA IDE hard drive or optical drive connected to an onboard Parallel ATA IDE connector

2.2.2.5.2 Reset Switch Header

Pins 5 and 7 can be connected to a momentary single pole, single throw (SPST) type switch that is normally open. When the switch is closed, the board resets and runs the POST.

2.2.2.5.3 Power/Sleep LED Header

Pins 2 and 4 can be connected to a one- or two-color LED. Table 24 shows the possible states for a one-color LED. Table 25 shows the possible states for a two-color LED.

Table 24. States for a One-Color Power LED

| LED State | Description |
|--------------|--------------------|
| Off | Power off/sleeping |
| Steady Green | Running |

Table 25. States for a Two-Color Power LED

| LED State | Description |
|---------------|-------------|
| Off | Power off |
| Steady Green | Running |
| Steady Yellow | Sleeping |



NOTE

The colors listed in Table 24 and Table 25 are suggested colors only. Actual LED colors are chassis-specific.

2.2.2.5.4 Power Switch Header

Pins 6 and 8 can be connected to a front panel momentary-contact power switch. The switch must pull the SW_ON# pin to ground for at least 50 ms to signal the power supply to switch on or off. (The time requirement is due to internal debounce circuitry on the board.) At least two seconds must pass before the power supply will recognize another on/off signal.

2.2.2.6 Front Panel USB Headers

Figure 12 is a connection diagram for the front panel USB headers.

INTEGRATOR'S NOTES

- The +5 V DC power on the USB headers is fused.
- Use only a front panel USB connector that conforms to the USB 2.0 specification for high-speed USB devices.

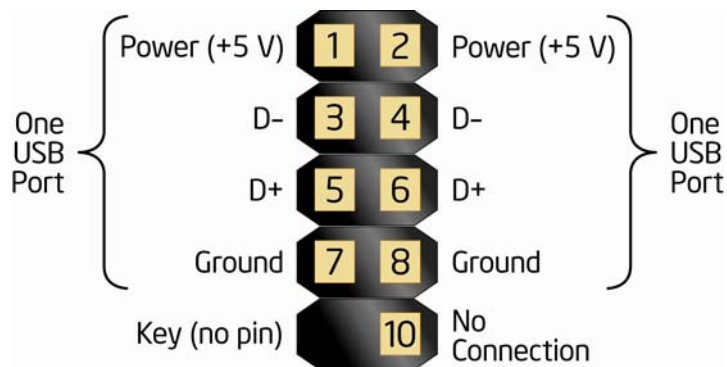

OM20473

Figure 12. Connection Diagram for Front Panel USB Headers

2.2.2.7 Front Panel IEEE 1394a Header

Figure 13 is a connection diagram for the IEEE 1394a header.

INTEGRATOR'S NOTES

- The +12 V DC power on the IEEE 1394a header is fused.
- The IEEE 1394a header provides one IEEE 1394a port.

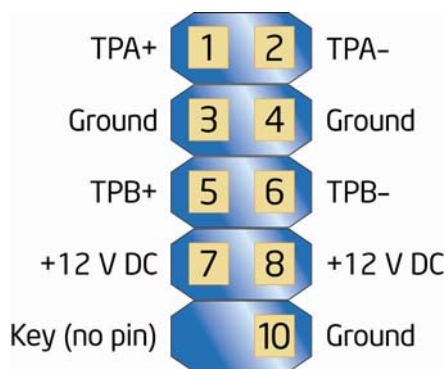

OM20474

Figure 13. Connection Diagram for IEEE 1394a Header

2.3 Jumper Block



CAUTION

Do not move the jumper with the power on. Always turn off the power and unplug the power cord from the computer before changing a jumper setting. Otherwise, the board could be damaged.

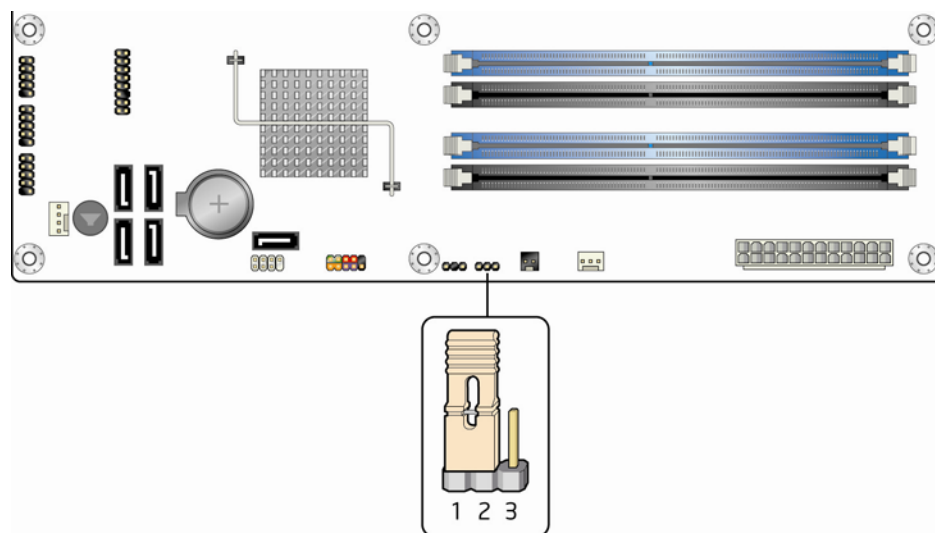
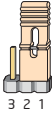
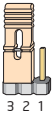

Figure 14 shows the location of the jumper block. The 3-pin jumper block determines the BIOS Setup program's mode. Table 26 describes the jumper settings for the three modes: normal, configure, and recovery. When the jumper is set to configure mode and the computer is powered-up, the BIOS compares the processor version and the microcode version in the BIOS and reports if the two match.



OM20804

Figure 14. Location of the Jumper Block

Table 26. BIOS Setup Configuration Jumper Settings

| Function/Mode | Jumper Setting | Configuration |
|---------------|---------------------------------------------------------------------------------------------|---------------------------------------------------------------------------------------|
| Normal | 1-2  | The BIOS uses current configuration information and passwords for booting. |
| Configure | 2-3  | After the POST runs, Setup runs automatically. The maintenance menu is displayed. |
| Recovery | None  | The BIOS attempts to recover the BIOS configuration. A recovery diskette is required. |

2.4 Mechanical Considerations

2.4.1 Form Factor

The board is designed to fit into an ATX-form-factor chassis. Figure 15 illustrates the mechanical form factor for the board. Dimensions are given in inches [millimeters]. The outer dimensions are 11.60 inches by 9.60 inches [294.60 millimeters by 243.84 millimeters]. Location of the I/O connectors and mounting holes are in compliance with the ATX specification.

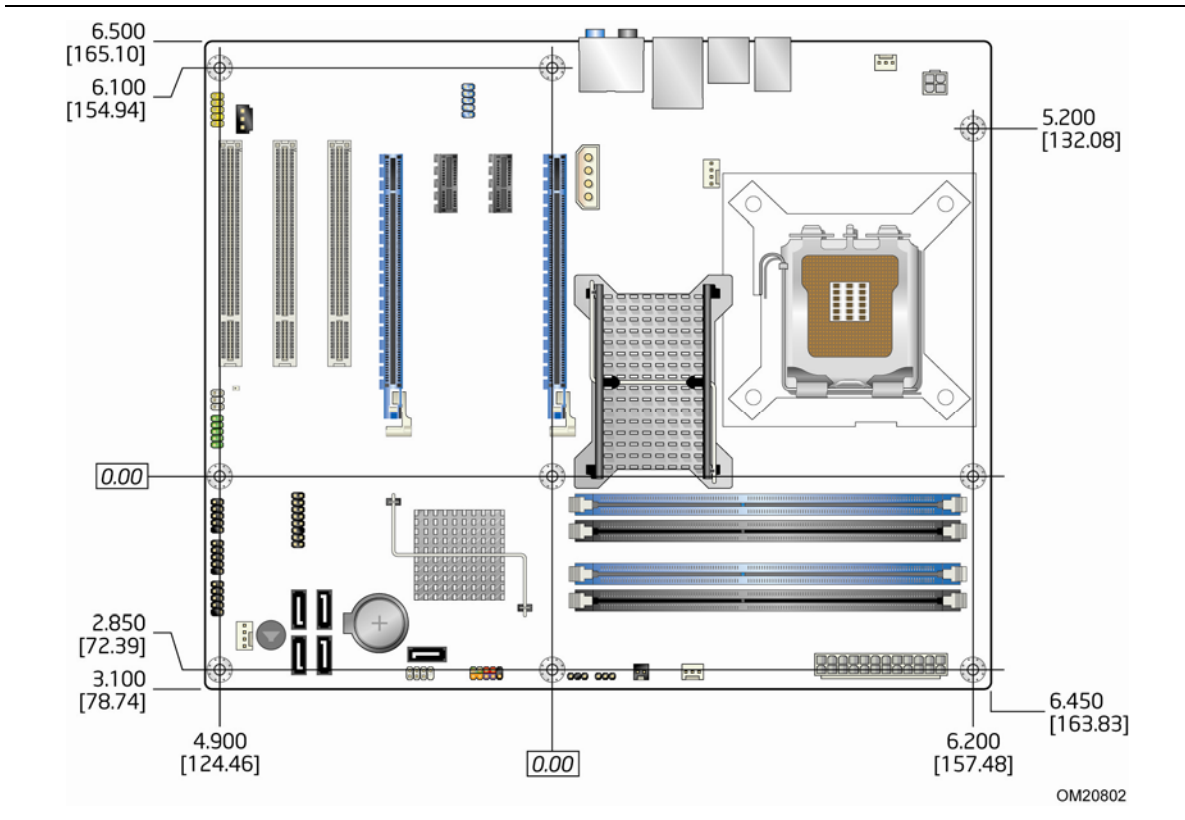

Figure 15. Board Dimensions

2.5 Electrical Considerations

2.5.1 Power Supply Considerations



CAUTION

The +5 V standby line from the power supply must be capable of providing adequate +5 V standby current. Failure to do so can damage the power supply. The total amount of standby current required depends on the wake devices supported and manufacturing options.

Additional power required will depend on configurations chosen by the integrator.

The power supply must comply with the indicated parameters of the ATX form factor specification.

- The potential relation between 3.3 VDC and +5 VDC power rails
- The current capability of the +5 VSB line
- All timing parameters
- All voltage tolerances

For example, for a system consisting of a supported 130 W processor (see section 1.4 on page 14 for a list of supported processors), 1 GB DDR3 RAM, one high end video card, one hard disk drive, one optical drive, and all board peripherals enabled, the minimum recommended power supply is 460 W. Table 27 lists the recommended power supply current values.

Table 27. Recommended Power Supply Current Values

| | | | | | | |
|-----------------------|-------|------|-------|-------|-------|-------|
| Output Voltage | 3.3 V | 5 V | 12 V1 | 12 V2 | -12 V | 5 VSB |
| Current | 22 A | 20 A | 16 A | 16 A | 0.3 A | 1.5 A |

2.5.2 Fan Header Current Capability



CAUTION

The processor fan must be connected to the processor fan header, not to a chassis fan header. Connecting the processor fan to a chassis fan header may result in onboard component damage that will halt fan operation.

Table 28 lists the current capability of the fan headers.

Table 28. Fan Header Current Capability

| Fan Header | Maximum Available Current |
|----------------------------|---------------------------|
| Processor fan | 2.0 A |
| Front chassis fan | 1.5 A |
| Rear chassis fan | 1.5 A |
| Auxiliary rear chassis fan | 2.0 A |

2.5.3 Add-in Board Considerations

The board is designed to provide 2 A (average) of current for each add-in board from the +5 V rail. The total +5 V current draw for add-in boards for a fully loaded board (all seven expansion slots filled) must not exceed the system's power supply +5 V maximum current or 14 A in total.

2.6 Thermal Considerations



CAUTION

A chassis with a maximum internal ambient temperature of 38 °C at the processor fan inlet is a requirement. Use a processor heat sink that provides omni-directional airflow to maintain required airflow across the processor voltage regulator area.



CAUTION

Failure to ensure appropriate airflow may result in reduced performance of both the processor and/or voltage regulator or, in some instances, damage to the board. For a list of chassis that have been tested with Intel desktop boards please refer to the following website:

<http://developer.intel.com/design/motherbd/cooling.htm>

All responsibility for determining the adequacy of any thermal or system design remains solely with the reader. Intel makes no warranties or representations that merely following the instructions presented in this document will result in a system with adequate thermal performance.

**CAUTION**

Ensure that the ambient temperature does not exceed the board's maximum operating temperature. Failure to do so could cause components to exceed their maximum case temperature and malfunction. For information about the maximum operating temperature, see the environmental specifications in Section 2.7.

**CAUTION**

Ensure that proper airflow is maintained in the processor voltage regulator circuit. Failure to do so may result in damage to the voltage regulator circuit. The processor voltage regulator area (shown in Figure 16) can reach a temperature of up to 85 °C in an open chassis.

Figure 16 shows the locations of the localized high temperature zones.

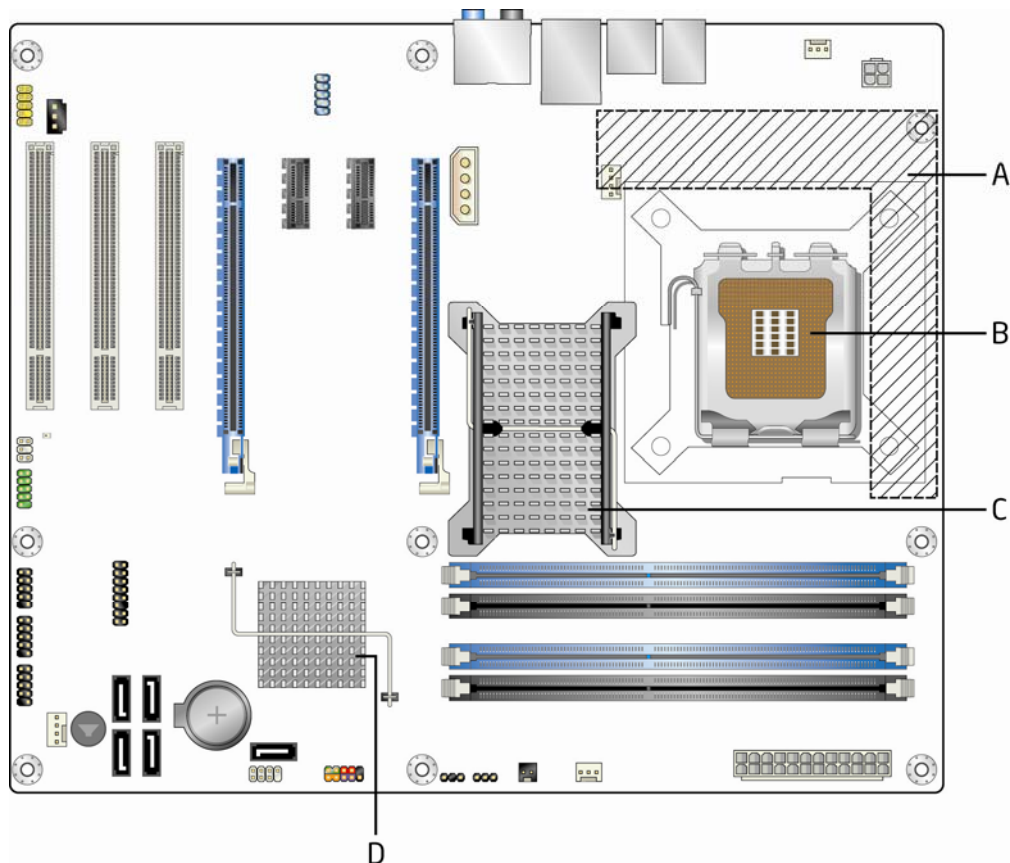

OM20803

| Item | Description |
|------|----------------------------------|
| A | Processor voltage regulator area |
| B | Processor |
| C | Intel 82P45 MCH |
| D | Intel 82801JR ICH10R |

Figure 16. Localized High Temperature Zones

Table 29 provides maximum case temperatures for the components that are sensitive to thermal changes. The operating temperature, current load, or operating frequency could affect case temperatures. Maximum case temperatures are important when considering proper airflow to cool the board.

Table 29. Thermal Considerations for Components

| Component | Maximum Case Temperature |
|------------------------|----------------------------------------------------------------------------------------------|
| Processor | For processor case temperature, see processor datasheets and processor specification updates |
| Intel 82P45 MCH | 97 °C (under bias) |
| Intel 82801JR (ICH10R) | 92 °C (under bias) |

For information about

Processor datasheets and specification updates
 Intel P45 Express chipset datasheets, specification updates,
 and design guides

Refer to

Section 1.3, page 14
<http://www.intel.com/products/chipsets/index.htm>

2.7 Reliability

The Mean Time Between Failures (MTBF) prediction is calculated using component and subassembly random failure rates. The calculation is based on the Bellcore Reliability Prediction Procedure, TR-NWT-000332, Issue 4, September 1991. The MTBF prediction is used to estimate repair rates and spare parts requirements. The MTBF data is calculated from predicted data at 55 °C.

The MTBF for this board will be provided in a Motherboard Specification Update (MSU) when available.

2.8 Environmental

Table 30 lists the environmental specifications for the board.

Table 30. Environmental Specifications

| Parameter | Specification | | |
|--------------------|-------------------------------------------------------------------------------------------------------------------------------------|--------------------|--------------------------------------------|
| Temperature | | | |
| Non-Operating | -20 °C to +70 °C | | |
| Operating | 0 °C to +55 °C | | |
| Shock | | | |
| Unpackaged | 50 g trapezoidal waveform Velocity change of 170 inches/second ² | | |
| Packaged | Half sine 2 millisecond | | |
| | Product Weight (pounds) | Free Fall (inches) | Velocity Change (inches/sec ²) |
| | <20 | 36 | 167 |
| | 21-40 | 30 | 152 |
| | 41-80 | 24 | 136 |
| | 81-100 | 18 | 118 |
| Vibration | | | |
| Unpackaged | 5 Hz to 20 Hz: 0.01 g ² Hz sloping up to 0.02 g ² Hz 20 Hz to 500 Hz: 0.02 g ² Hz (flat) | | |
| Packaged | 5 Hz to 40 Hz: 0.015 g ² Hz (flat) 40 Hz to 500 Hz: 0.015 g ² Hz sloping down to 0.00015 g ² Hz | | |

3 Overview of BIOS Features

3.1 Introduction

The board uses an Intel BIOS that is stored in the Serial Peripheral Interface Flash Memory (SPI Flash) and can be updated using a disk-based program. The SPI Flash contains the BIOS Setup program, POST, the PCI auto-configuration utility, LAN EEPROM information, and Plug and Play support.

The BIOS displays a message during POST identifying the type of BIOS and a revision code. The initial production BIOSs are identified as SGP4510H.86A.

When the BIOS Setup configuration jumper is set to configure mode and the computer is powered-up, the BIOS compares the CPU version and the microcode version in the BIOS and reports if the two match.

The BIOS Setup program can be used to view and change the BIOS settings for the computer. The BIOS Setup program is accessed by pressing the <F2> key after the Power-On Self-Test (POST) memory test begins and before the operating system boot begins. The menu bar is shown below.

| | | | | | | | |
|-------------|------|----------|-------------|----------|-------|------|------|
| Maintenance | Main | Advanced | Performance | Security | Power | Boot | Exit |
|-------------|------|----------|-------------|----------|-------|------|------|



NOTE

The maintenance menu is displayed only when the board is in configure mode. Section 2.3 on page 51 shows how to put the board in configure mode.

Table 31 lists the BIOS Setup program menu features.

Table 31. BIOS Setup Program Menu Bar

| Maintenance | Main | Advanced | Performance | Security | Power | Boot | Exit |
|-----------------------------------------------------|---------------------------------------------|------------------------------------------------------------|------------------------------------------------|--------------------------------------|----------------------------------------------------------------|----------------------|----------------------------------------------------|
| Clears passwords and displays processor information | Displays processor and memory configuration | Configures advanced features available through the chipset | Configures Memory, Bus and Processor overrides | Sets passwords and security features | Configures power management features and power supply controls | Selects boot options | Saves or discards changes to Setup program options |

Table 32 lists the function keys available for menu screens.

Table 32. BIOS Setup Program Function Keys

| BIOS Setup Program Function Key | Description |
|---------------------------------|------------------------------------------------------------------|
| <<-> or <->> | Selects a different menu screen (Moves the cursor left or right) |
| <↑> or <↓> | Selects an item (Moves the cursor up or down) |
| <Tab> | Selects a field (Not implemented) |
| <Enter> | Executes command or selects the submenu |
| <F9> | Load the default configuration values for the current menu |
| <F10> | Save the current values and exits the BIOS Setup program |
| <Esc> | Exits the menu |

3.2 BIOS Flash Memory Organization

The Serial Peripheral Interface Flash Memory (SPI Flash) includes an 32 Mbit (4096 KB) flash memory device

3.3 Resource Configuration

3.3.1 PCI Autoconfiguration

The BIOS can automatically configure PCI devices. PCI devices may be onboard or add-in cards. Autoconfiguration lets a user insert or remove PCI cards without having to configure the system. When a user turns on the system after adding a PCI card, the BIOS automatically configures interrupts, the I/O space, and other system resources. Any interrupts set to Available in Setup are considered to be available for use by the add-in card.

3.4 System Management BIOS (SMBIOS)

SMBIOS is a Desktop Management Interface (DMI) compliant method for managing computers in a managed network.

The main component of SMBIOS is the Management Information Format (MIF) database, which contains information about the computing system and its components. Using SMBIOS, a system administrator can obtain the system types, capabilities, operational status, and installation dates for system components. The MIF database defines the data and provides the method for accessing this information. The BIOS enables applications such as third-party management software to use SMBIOS. The BIOS stores and reports the following SMBIOS information:

- BIOS data, such as the BIOS revision level
- Fixed-system data, such as peripherals, serial numbers, and asset tags
- Resource data, such as memory size, cache size, and processor speed
- Dynamic data, such as event detection and error logging

Non-Plug and Play operating systems require an additional interface for obtaining the SMBIOS information. The BIOS supports an SMBIOS table interface for such operating systems. Using this support, an SMBIOS service-level application running on a non-Plug and Play operating system can obtain the SMBIOS information. Additional board information can be found in the BIOS under the Additional Information header under the Main BIOS page.

3.5 Legacy USB Support

Legacy USB support enables USB devices to be used even when the operating system's USB drivers are not yet available. Legacy USB support is used to access the BIOS Setup program, and to install an operating system that supports USB. By default, Legacy USB support is set to Enabled.

Legacy USB support operates as follows:

1. When you apply power to the computer, legacy support is disabled.
2. POST begins.
3. Legacy USB support is enabled by the BIOS allowing you to use a USB keyboard to enter and configure the BIOS Setup program and the maintenance menu.
4. POST completes.
5. The operating system loads. While the operating system is loading, USB keyboards and mice are recognized and may be used to configure the operating system. (Keyboards and mice are not recognized during this period if Legacy USB support was set to Disabled in the BIOS Setup program.)
6. After the operating system loads the USB drivers, all legacy and non-legacy USB devices are recognized by the operating system, and Legacy USB support from the BIOS is no longer used.
7. Additional USB legacy feature options can be access by using Intel Integrator Toolkit.

To install an operating system that supports USB, verify that Legacy USB support in the BIOS Setup program is set to Enabled and follow the operating system's installation instructions.

3.6 BIOS Updates

The BIOS can be updated using either of the following utilities, which are available on the Intel World Wide Web site:

- Intel® Express BIOS Update utility, which enables automated updating while in the Windows environment. Using this utility, the BIOS can be updated from a file on a hard disk, a USB drive (a flash drive or a USB hard drive), or a CD-ROM, or from the file location on the Web.
- Intel® Flash Memory Update Utility, which requires booting from DOS. Using this utility, the BIOS can be updated from a file on a hard disk, a USB drive (a flash drive or a USB hard drive), or a CD-ROM.

Both utilities verify that the updated BIOS matches the target system to prevent accidentally installing an incompatible BIOS.



NOTE

Review the instructions distributed with the upgrade utility before attempting a BIOS update.

| For information about | Refer to |
|------------------------------|-----------------|
|------------------------------|-----------------|

| | |
|-----------------------|-------------------------------------------------------------------------------------------------------------------------------------------------------------|
| BIOS update utilities | http://support.intel.com/support/motherboards/desktop/sb/CS-022312.htm |
|-----------------------|-------------------------------------------------------------------------------------------------------------------------------------------------------------|

3.6.1 Language Support

The BIOS Setup program and help messages are supported in US English. Additional languages are available in the Integrator Toolkit utility. Check the Intel website for details.

3.6.2 Custom Splash Screen

During POST, an Intel® splash screen is displayed by default. This splash screen can be augmented with a custom splash screen. The Intel® Integrator Toolkit or Intel® Integrator Assistant that are available from Intel can be used to create a custom splash screen.



NOTE

If you add a custom splash screen, it will share space with the Intel branded logo.

| For information about | Refer to |
|---------------------------------|-----------------------------------------------------------------------------------------------------------------------------------------------------------------------------------------------------------------------------------------------------------------------------------------|
| Intel® Integrator Toolkit | http://developer.intel.com/design/motherbd/software/itk/ |
| Additional Intel software tools | http://developer.intel.com/products/motherboard/DP45SG/tools.htm and http://developer.intel.com/design/motherbd/software.htm |

3.7 BIOS Recovery

It is unlikely that anything will interrupt a BIOS update; however, if an interruption occurs, the BIOS could be damaged. Table 33 lists the drives and media types that can and cannot be used for BIOS recovery. The BIOS recovery media does not need to be made bootable.

Table 33. Acceptable Drives/Media Types for BIOS Recovery

| Media Type | Can be used for BIOS recovery? |
|------------------------------------------------------|--------------------------------|
| CD-ROM drive connected to the Serial ATA interface | Yes |
| USB removable drive (a USB Flash Drive, for example) | Yes |
| USB diskette drive (with a 1.44 MB diskette) | No |
| USB hard disk drive | No |

| For information about | Refer to |
|-----------------------|-------------------------------------------------------------------------------------------------------------------------------------------------------------|
| BIOS recovery | http://support.intel.com/support/motherboards/desktop/sb/CS-023360.htm |

3.8 Boot Options

In the BIOS Setup program, the user can choose to boot from a diskette drive, hard drive, USB drive, USB flash drive, CD-ROM, or the network. The default setting is for the diskette drive to be the first boot device, the hard drive second, and the ATAPI CD-ROM third. If enabled, the last default boot device is the network.

3.8.1 CD-ROM Boot

Booting from CD-ROM is supported in compliance to the El Torito bootable CD-ROM format specification. Under the Boot menu in the BIOS Setup program, ATAPI CD-ROM is listed as a boot device. Boot devices are defined in priority order. Accordingly, if there is not a bootable CD in the CD-ROM drive, the system will attempt to boot from the next defined drive.

3.8.2 Network Boot

The network can be selected as a boot device. This selection allows booting from the onboard LAN or a network add-in card with a remote boot ROM installed.

Pressing the <F12> key during POST automatically forces booting from the LAN. To use this key during POST, the User Access Level in the BIOS Setup program's Security menu must be set to Full.

3.8.3 Booting Without Attached Devices

For use in embedded applications, the BIOS has been designed so that after passing the POST, the operating system loader is invoked even if the following devices are not present:

- Video adapter
- Keyboard
- Mouse

3.8.4 Changing the Default Boot Device During POST

Pressing the <F10> key during POST causes a boot device menu to be displayed. This menu displays the list of available boot devices (as set in the BIOS setup program's Boot Device Priority Submenu). Table 34 lists the boot device menu options.

Table 34. Boot Device Menu Options

| Boot Device Menu Function Keys | Description |
|--------------------------------|-------------------------------------------------------------------|
| <↑> or <↓> | Selects a default boot device |
| <Enter> | Exits the menu, saves changes, and boots from the selected device |
| <Esc> | Exits the menu without saving changes |

3.9 Adjusting Boot Speed

These factors affect system boot speed:

- Selecting and configuring peripherals properly
- Optimized BIOS boot parameters

3.9.1 Peripheral Selection and Configuration

The following techniques help improve system boot speed:

- Choose a hard drive with parameters such as “power-up to data ready” less than eight seconds, that minimize hard drive startup delays.
- Select a CD-ROM drive with a fast initialization rate. This rate can influence POST execution time.
- Eliminate unnecessary add-in adapter features, such as logo displays, screen repaints, or mode changes in POST. These features may add time to the boot process.
- Try different monitors. Some monitors initialize and communicate with the BIOS more quickly, which enables the system to boot more quickly.

3.9.2 BIOS Boot Optimizations

Use of the following BIOS Setup program settings reduces the POST execution time.

- In the Boot Menu, set the hard disk drive as the first boot device. As a result, the POST does not first seek a diskette drive, which saves about one second from the POST execution time.
- In the Peripheral Configuration submenu, disable the LAN device if it will not be used. This can reduce up to four seconds of option ROM boot time.



NOTE

It is possible to optimize the boot process to the point where the system boots so quickly that the Intel logo screen (or a custom logo splash screen) will not be seen. Monitors and hard disk drives with minimum initialization times can also contribute to a boot time that might be so fast that necessary logo screens and POST messages cannot be seen.

This boot time may be so fast that some drives might be not be initialized at all. If this condition should occur, it is possible to introduce a programmable delay ranging from zero to 30 seconds by 5 second increments (using the Hard Disk Pre-Delay feature of the Advanced Menu in the Drive Configuration Submenu of the BIOS Setup program).

3.10 BIOS Security Features

The BIOS includes security features that restrict access to the BIOS Setup program and who can boot the computer. A supervisor password and a user password can be set for the BIOS Setup program and for booting the computer, with the following restrictions:

- The supervisor password gives unrestricted access to view and change all the Setup options in the BIOS Setup program. This is the supervisor mode.
- The user password gives restricted access to view and change Setup options in the BIOS Setup program. This is the user mode.
- If only the supervisor password is set, pressing the <Enter> key at the password prompt of the BIOS Setup program allows the user restricted access to Setup.
- If both the supervisor and user passwords are set, users can enter either the supervisor password or the user password to access Setup. Users have access to Setup respective to which password is entered.
- Setting the user password restricts who can boot the computer. The password prompt will be displayed before the computer is booted. If only the supervisor password is set, the computer boots without asking for a password. If both passwords are set, the user can enter either password to boot the computer.
- For enhanced security, use different passwords for the supervisor and user passwords.
- Valid password characters are A-Z, a-z, and 0-9. Passwords may be up to 16 characters in length.

Table 35 shows the effects of setting the supervisor password and user password. This table is for reference only and is not displayed on the screen.

Table 35. Supervisor and User Password Functions

| Password Set | Supervisor Mode | User Mode | Setup Options | Password to Enter Setup | Password During Boot |
|-------------------------|-------------------------------|----------------------------------------|---------------------------------------|--------------------------------|-----------------------------|
| Neither | Can change all options (Note) | Can change all options (Note) | None | None | None |
| Supervisor only | Can change all options | Can change a limited number of options | Supervisor Password | Supervisor | None |
| User only | N/A | Can change all options | Enter Password Clear User Password | User | User |
| Supervisor and user set | Can change all options | Can change a limited number of options | Supervisor Password Enter Password | Supervisor or user | Supervisor or user |

Note: If no password is set, any user can change all Setup options.

4 Error Messages and Beep Codes

4.1 Speaker

The board-mounted speaker provides audible error code (beep code) information during POST.

For information about

The location of the onboard speaker

Refer to

Figure 1, page 11

4.2 BIOS Beep Codes

Whenever a recoverable error occurs during POST, the BIOS causes the board's speaker to beep an error message describing the problem (see Table 36).

Table 36. Beep Codes

| Type | Pattern | Frequency |
|-----------------|---------------------------------------------------------------------|-----------------------------------------|
| Memory error | Three long beeps | 1280 Hz |
| Thermal warning | Four alternating beeps: High tone, low tone, high tone, low tone | High tone: 2000 Hz Low tone: 1600 Hz |

4.3 BIOS Error Messages

Whenever a recoverable error occurs during POST, the BIOS displays an error message describing the problem. Table 37 lists the error messages and provides a brief description of each.

Table 37. BIOS Error Messages

| Error Message | Explanation |
|--------------------------|--------------------------------------------------------------------------------------------------|
| CMOS Battery Low | The battery may be losing power. Replace the battery soon. |
| CMOS Checksum Bad | The CMOS checksum is incorrect. CMOS memory may have been corrupted. Run Setup to reset values. |
| Memory Size Decreased | Memory size has decreased since the last boot. If no memory was removed, then memory may be bad. |
| No Boot Device Available | System did not find a device to boot. |

4.4 Port 80h POST Codes

During the POST, the BIOS generates diagnostic progress codes (POST codes) to I/O port 80h. If the POST fails, execution stops and the last POST code generated is left at port 80h. This code is useful for determining the point where an error occurred.

Displaying the POST codes requires a PCI bus add-in card, often called a POST card. The POST card can decode the port and display the contents on a medium such as a seven-segment display.



NOTE

The POST card must be installed in PCI bus connector 1.

The following tables provide information about the POST codes generated by the BIOS:

- Table 38 lists the Port 80h POST code ranges
- Table 39 lists the Port 80h POST codes themselves
- Table 40 lists the Port 80h POST sequence



NOTE

In the tables listed above, all POST codes and range values are listed in hexadecimal.

Table 38. Port 80h POST Code Ranges

| Range | Category/Subsystem |
|---------|----------------------------------------------------------------------------------------------------------------|
| 00 – 0F | Debug codes: Can be used by any PEIM/driver for debug. |
| 10 – 1F | Host Processors: 1F is an unrecoverable CPU error. |
| 20 – 2F | Memory/Chipset: 2F is no memory detected or no useful memory detected. |
| 30 – 3F | Recovery: 3F indicated recovery failure. |
| 40 – 4F | Reserved for future use. |
| 50 – 5F | I/O Busses: PCI, USB, ATA, etc. 5F is an unrecoverable error. Start with PCI. |
| 60 – 6F | Reserved for future use (for new busses). |
| 70 – 7F | Output Devices: All output consoles. 7F is an unrecoverable error. |
| 80 – 8F | Reserved for future use (new output console codes). |
| 90 – 9F | Input devices: Keyboard/Mouse. 9F is an unrecoverable error. |
| A0 – AF | Reserved for future use (new input console codes). |
| B0 – BF | Boot Devices: Includes fixed media and removable media. BF is an unrecoverable error. |
| C0 – CF | Reserved for future use. |
| D0 – DF | Boot device selection. |
| E0 – FF | E0 – EE: Miscellaneous codes. See Table 39. EF: boot/S3 resume failure. F0 – FF: FF processor exception. |

Table 39. Port 80h POST Codes

| POST Code | Description of POST Operation |
|-----------------------|----------------------------------------------------------------------|
| Host Processor | |
| 10 | Power-on initialization of the host processor (Boot Strap Processor) |
| 11 | Host processor cache initialization (including APs) |
| 12 | Starting Application processor initialization |
| 13 | SMM initialization |
| Chipset | |
| 21 | Initializing a chipset component |
| Memory | |
| 22 | Reading SPD from memory DIMMs |
| 23 | Detecting presence of memory DIMMs |
| 24 | Programming timing parameters in the memory controller and the DIMMs |
| 25 | Configuring memory |
| 26 | Optimizing memory settings |
| 27 | Initializing memory, such as ECC init |
| 29 | Memory testing completed |
| PCI Bus | |
| 50 | Enumerating PCI busses |
| 51 | Allocating resources to PCI bus |
| 52 | Hot Plug PCI controller initialization |
| 53 – 57 | Reserved for PCI Bus |
| USB | |
| 58 | Resetting USB bus |
| 59 | Reserved for USB |
| ATA/ATAPI/SATA | |
| 5A | Resetting PATA/SATA bus and all devices |
| 5B | Reserved for ATA |
| SMBus | |
| 5C | Resetting SMBus |
| 5D | Reserved for SMBus |
| Local Console | |
| 70 | Resetting the VGA controller |
| 71 | Disabling the VGA controller |
| 72 | Enabling the VGA controller |
| Remote Console | |
| 78 | Resetting the console controller |
| 79 | Disabling the console controller |
| 7A | Enabling the console controller |

continued

Table 39. Port 80h POST Codes (continued)

| POST Code | Description of POST Operation |
|------------------------|--------------------------------------------------------------------------------------------------------------|
| Keyboard (USB) | |
| 90 | Resetting keyboard |
| 91 | Disabling keyboard |
| 92 | Detecting presence of keyboard |
| 93 | Enabling the keyboard |
| 94 | Clearing keyboard input buffer |
| 95 | Instructing keyboard controller to run Self Test (PS/2 only) |
| Mouse (USB) | |
| 98 | Resetting mouse |
| 99 | Disabling mouse |
| 9A | Detecting presence of mouse |
| 9B | Enabling mouse |
| Fixed Media | |
| B0 | Resetting fixed media |
| B1 | Disabling fixed media |
| B2 | Detecting presence of a fixed media (IDE hard drive detection etc.) |
| B3 | Enabling/configuring a fixed media |
| Removable Media | |
| B8 | Resetting removable media |
| B9 | Disabling removable media |
| BA | Detecting presence of a removable media (IDE, CD-ROM detection, etc.) |
| BC | Enabling/configuring a removable media |
| BDS | |
| Dy | Trying boot selection y (y=0 to 15) |
| PEI Core | |
| E0 | Started dispatching PEIMs (emitted on first report of EFI_SW_PC_INIT_BEGIN EFI_SW_PEI_PC_HANDOFF_TO_NEXT) |
| E2 | Permanent memory found |
| E1, E3 | Reserved for PEI/PEIMs |
| DXE Core | |
| E4 | Entered DXE phase |
| E5 | Started dispatching drivers |
| E6 | Started connecting drivers |

continued

Table 39. Port 80h POST Codes (continued)

| POST Code | Description of POST Operation |
|------------------|--------------------------------------------------------------|
| | DXE Drivers |
| E7 | Waiting for user input |
| E8 | Checking password |
| E9 | Entering BIOS setup |
| EB | Calling Legacy Option ROMs |
| | Runtime Phase/EFI OS Boot |
| F4 | Entering Sleep state |
| F5 | Exiting Sleep state |
| F8 | EFI boot service ExitBootServices () has been called |
| F9 | EFI runtime service SetVirtualAddressMap () has been called |
| FA | EFI runtime service ResetSystem () has been called |
| | PEIMs/Recovery |
| 30 | Crisis Recovery has initiated per user request |
| 31 | Crisis Recovery has initiated by software (corrupt flash) |
| 34 | Loading recovery capsule |
| 35 | Handing off control to the recovery capsule |
| 3F | Unable to recover |

Table 40. Typical Port 80h POST Sequence

| POST Code | Description |
|------------------|-----------------------------------------------|
| 21 | Initializing a chipset component |
| 22 | Reading SPD from memory DIMMs |
| 23 | Detecting presence of memory DIMMs |
| 25 | Configuring memory |
| 28 | Testing memory |
| 34 | Loading recovery capsule |
| E4 | Entered DXE phase |
| 12 | Starting application processor initialization |
| 13 | SMM initialization |
| 50 | Enumerating PCI busses |
| 51 | Allocating resourced to PCI bus |
| 92 | Detecting the presence of the keyboard |
| 90 | Resetting keyboard |
| 94 | Clearing keyboard input buffer |
| 95 | Keyboard Self Test |
| EB | Calling Video BIOS |
| 58 | Resetting USB bus |
| 5A | Resetting PATA/SATA bus and all devices |
| 92 | Detecting the presence of the keyboard |
| 90 | Resetting keyboard |
| 94 | Clearing keyboard input buffer |
| 5A | Resetting PATA/SATA bus and all devices |
| 28 | Testing memory |
| 90 | Resetting keyboard |
| 94 | Clearing keyboard input buffer |
| E7 | Waiting for user input |
| 01 | INT 19 |
| 00 | Ready to boot |

5 Regulatory Compliance and Battery Disposal Information

5.1 Regulatory Compliance

This section contains the following regulatory compliance information for Intel Desktop Board DP45SG:

- Safety standards
- European Union Declaration of Conformity statement
- Product Ecology statements
- Electromagnetic Compatibility (EMC) standards
- Product certification markings

5.1.1 Safety Standards

Intel Desktop Board DP45SG complies with the safety standards stated in Table 41 when correctly installed in a compatible host system.

Table 41. Safety Standards

| Standard | Title |
|----------------------------------|-------------------------------------------------------------------------------------------|
| CSA/UL 60950-1, First Edition | Information Technology Equipment – Safety - Part 1: General Requirements (USA and Canada) |
| EN 60950-1:2006, Second Edition | Information Technology Equipment – Safety - Part 1: General Requirements (European Union) |
| IEC 60950-1:2005, Second Edition | Information Technology Equipment – Safety - Part 1: General Requirements (International) |

5.1.2 European Union Declaration of Conformity Statement

We, Intel Corporation, declare under our sole responsibility that the product Intel® Desktop Board DP45SG is in conformity with all applicable essential requirements necessary for CE marking, following the provisions of the European Council Directive 2004/108/EC (EMC Directive) and 2006/95/EC (Low Voltage Directive).

The product is properly CE marked demonstrating this conformity and is for distribution within all member states of the EU with no restrictions.



This product follows the provisions of the European Directives 2004/108/EC and 2006/95/EC.

Čeština Tento výrobek odpovídá požadavkům evropských směrnic 2004/108/EC a 2006/95/EC.

Dansk Dette produkt er i overensstemmelse med det europæiske direktiv 2004/108/EC & 2006/95/EC.

Dutch Dit product is in navolging van de bepalingen van Europees Directief 2004/108/EC & 2006/95/EC.

Eesti Antud toode vastab Euroopa direktiivides 2004/108/EC ja 2006/95/EC kehtestatud nõuetele.

Suomi Tämä tuote noudattaa EU-direktiivin 2004/108/EC & 2006/95/EC määräyksiä.

Français Ce produit est conforme aux exigences de la Directive Européenne 2004/108/EC & 2006/95/EC.

Deutsch Dieses Produkt entspricht den Bestimmungen der Europäischen Richtlinie 2004/108/EC & 2006/95/EC.

Ελληνικά Το παρόν προϊόν ακολουθεί τις διατάξεις των Ευρωπαϊκών Οδηγιών 2004/108/EC και 2006/95/EC.

Magyar E termék megfelel a 2004/108/EC és 2006/95/EC Európai Irányelv előírásainak.

Icelandic Þessi vara stenst reglugerð Evrópska Efnahags Bandalagsins númer 2004/108/EC & 2006/95/EC.

Italiano Questo prodotto è conforme alla Direttiva Europea 2004/108/EC & 2006/95/EC.

Latviešu Šis produkts atbilst Eiropas Direktīvu 2004/108/EC un 2006/95/EC noteikumiem.

Lietuvių Šis produktas atitinka Europos direktyvų 2004/108/EC ir 2006/95/EC nuostatas.

Malti Dan il-prodott hu konformi mal-provvedimenti tad-Direttivi Ewropej 2004/108/EC u 2006/95/EC.

Norsk Dette produktet er i henhold til bestemmelsene i det europeiske direktivet 2004/108/EC & 2006/95/EC.

Polski Niniejszy produkt jest zgodny z postanowieniami Dyrektyw Unii Europejskiej 2004/108/EC i 73/23/EWG.

Portuguese Este produto cumpre com as normas da Diretiva Europeia 2004/108/EC & 2006/95/EC.

Español Este producto cumple con las normas del Directivo Europeo 2004/108/EC & 2006/95/EC.

Slovensky Tento produkt je v súlade s ustanoveniami európskych direktív 2004/108/EC a 2006/95/EC.

Slovenščina Izdelek je skladen z določbami evropskih direktiv 2004/108/EC in 2006/95/EC.

Svenska Denna produkt har tillverkats i enlighet med EG-direktiv 2004/108/EC & 2006/95/EC.

Türkçe Bu ürün, Avrupa Birliği'nin 2004/108/EC ve 2006/95/EC yönergelerine uyar.

5.1.3 Product Ecology Statements

The following information is provided to address worldwide product ecology concerns and regulations.

5.1.3.1 Disposal Considerations

This product contains the following materials that may be regulated upon disposal: lead solder on the printed wiring board assembly.

5.1.3.2 Recycling Considerations

As part of its commitment to environmental responsibility, Intel has implemented the Intel Product Recycling Program to allow retail consumers of Intel's branded products to return used products to selected locations for proper recycling.

Please consult the http://www.intel.com/intel/other/ehs/product_ecology for the details of this program, including the scope of covered products, available locations, shipping instructions, terms and conditions, etc.

中文

作为其对环境责任之承诺的部分，英特尔已实施 Intel Product Recycling Program（英特尔产品回收计划），以允许英特尔品牌产品的零售消费者将使用过的产品退还至指定地点作恰当的重复使用处理。

请参考http://www.intel.com/intel/other/ehs/product_ecology了解此计划的详情，包括涉及产品之范围、回收地点、运送指导、条款和条件等。

Deutsch

Als Teil von Intels Engagement für den Umweltschutz hat das Unternehmen das Intel Produkt-Recyclingprogramm implementiert, das Einzelhandelskunden von Intel Markenprodukten ermöglicht, gebrauchte Produkte an ausgewählte Standorte für ordnungsgemäßes Recycling zurückzugeben.

Details zu diesem Programm, einschließlich der darin eingeschlossenen Produkte, verfügbaren Standorte, Versandanweisungen, Bedingungen usw., finden Sie auf der http://www.intel.com/intel/other/ehs/product_ecology

Español

Como parte de su compromiso de responsabilidad medioambiental, Intel ha implantado el programa de reciclaje de productos Intel, que permite que los consumidores al detalle de los productos Intel devuelvan los productos usados en los lugares seleccionados para su correspondiente reciclado.

Consulte la http://www.intel.com/intel/other/ehs/product_ecology para ver los detalles del programa, que incluye los productos que abarca, los lugares disponibles, instrucciones de envío, términos y condiciones, etc.

Français

Dans le cadre de son engagement pour la protection de l'environnement, Intel a mis en œuvre le programme Intel Product Recycling Program (Programme de recyclage des produits Intel) pour permettre aux consommateurs de produits Intel de recycler les produits usés en les retournant à des adresses spécifiées.

Visitez la page Web http://www.intel.com/intel/other/ehs/product_ecology pour en savoir plus sur ce programme, à savoir les produits concernés, les adresses disponibles, les instructions d'expédition, les conditions générales, etc.

日本語

インテルでは、環境保護活動の一環として、使い終わったインテルブランド製品を指定の場所へ返送していただき、リサイクルを適切に行えるよう、インテル製品リサイクルプログラムを発足させました。

対象製品、返送先、返送方法、ご利用規約など、このプログラムの詳細情報は、http://www.intel.com/intel/other/ehs/product_ecology (英語)をご覧ください。

Malay

Sebagai sebahagian daripada komitmennya terhadap tanggungjawab persekitaran, Intel telah melaksanakan Program Kitar Semula Produk untuk membenarkan pengguna-pengguna runcit produk jenama Intel memulangkan produk terguna ke lokasi-lokasi terpilih untuk dikitar semula dengan betul.

Sila rujuk http://www.intel.com/intel/other/ehs/product_ecology untuk mendapatkan butir-butir program ini, termasuklah skop produk yang dirangkumi, lokasi-lokasi tersedia, arahan penghantaran, terma & syarat, dsb.

Portuguese

Como parte deste compromisso com o respeito ao ambiente, a Intel implementou o Programa de Reciclagem de Produtos para que os consumidores finais possam enviar produtos Intel usados para locais selecionados, onde esses produtos são reciclados de maneira adequada.

Consulte o site http://www.intel.com/intel/other/ehs/product_ecology (em Inglês) para obter os detalhes sobre este programa, inclusive o escopo dos produtos cobertos, os locais disponíveis, as instruções de envio, os termos e condições, etc.

Russian

В качестве части своих обязательств к окружающей среде, в Intel создана программа утилизации продукции Intel (Product Recycling Program) для предоставления конечным пользователям марок продукции Intel возможности возврата используемой продукции в специализированные пункты для должной утилизации.

Пожалуйста, обратитесь на веб-сайт

http://www.intel.com/intel/other/ehs/product_ecology за информацией об этой программе, принимаемых продуктах, местах приема, инструкциях об отправке, положениях и условиях и т.д.

Türkçe

Intel, çevre sorumluluğuna bağlılığının bir parçası olarak, perakende tüketicilerin Intel markalı kullanılmış ürünlerini belirlenmiş merkezlere iade edip uygun şekilde geri dönüştürmesini amaçlayan Intel Ürünleri Geri Dönüşüm Programı'nı uygulamaya koymuştur.

Bu programın ürün kapsamı, ürün iade merkezleri, nakliye talimatları, kayıtlar ve şartlar v.s dahil bütün ayrıntılarını öğrenmek için lütfen

http://www.intel.com/intel/other/ehs/product_ecology

Web sayfasına gidin.

5.1.3.3 Lead Free Desktop Board



This Desktop Board is a European Union Restriction of Hazardous Substances (EU RoHS Directive 2002/95/EC) compliant product. EU RoHS restricts the use of six materials. One of the six restricted materials is lead.

This Desktop Board is lead free although certain discrete components used on the board contain a small amount of lead which is necessary for component performance and/or reliability. This Desktop Board is referred to as "Lead-free second level interconnect." The board substrate and the solder connections from the board to the components (second-level connections) are all lead free.

China bans the same substances and has the same limits as EU RoHS; however it requires different product marking and controlled substance information. The required mark shows the Environmental Friendly Usage Period (EFUP). The EFUP is defined as the number of years for which controlled listed substances will not leak or chemically deteriorate while in the product.

Table 42 shows the various forms of the "Lead-Free 2nd Level Interconnect" mark as it appears on the board and accompanying collateral.

Table 42. Lead-Free Board Markings

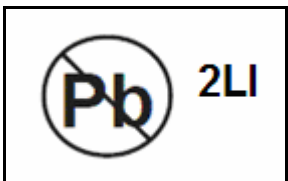
| Description | Mark |
|-----------------------------------------------------------------------------------------------------------------------------------------------------------------------------------------------------------------------------------------------------------------------------------------------------------------------------------------------------------------------------------|------------------------------------------------------------------------------------|
| <p>Lead-Free 2nd Level Interconnect: This symbol is used to identify electrical and electronic assemblies and components in which the lead (Pb) concentration level in the desktop board substrate and the solder connections from the board to the components (second-level interconnect) is not greater than 0.1% by weight (1000 ppm).</p> |  |
| | <p>or</p> |
| |  |
| <p>or</p> | |
|  | |

5.1.4 EMC Regulations

Intel Desktop Board DP45SG complies with the EMC regulations stated in Table 43 when correctly installed in a compatible host system.

Table 43. EMC Regulations

| Regulation | Title |
|-------------------------------------------|-------------------------------------------------------------------------------------------------------------------------------|
| FCC 47 CFR Part 15, Subpart B | Title 47 of the Code of Federal Regulations, Part15, Subpart B, Radio Frequency Devices. (USA) |
| ICES-003 Issue 4 (Class B) | Interference-Causing Equipment Standard, Digital Apparatus. (Canada) |
| EN55022:2006 (Class B) | Limits and methods of measurement of Radio Interference Characteristics of Information Technology Equipment. (European Union) |
| EN55024:1998 (Class B) | Information Technology Equipment – Immunity Characteristics Limits and methods of measurement. (European Union) |
| EN55022:2006 (Class B) | Australian Communications Authority, Standard for Electromagnetic Compatibility. (Australia and New Zealand) |
| CISPR 22:2005 +A1:2005 +A2:2006 (Class B) | Limits and methods of measurement of Radio Disturbance Characteristics of Information Technology Equipment. (International) |
| CISPR 24:1997 +A1:2001 +A2:2002 (Class B) | Information Technology Equipment – Immunity Characteristics – Limits and Methods of Measurement. (International) |
| VCCI V-3/2007.04, V-4/2007.04, Class B | Voluntary Control for Interference by Information Technology Equipment. (Japan) |

Japanese Kanji statement translation: this is a Class B product based on the standard of the Voluntary Control Council for Interference from Information Technology Equipment (VCCI). If this is used near a radio or television receiver in a domestic environment, it may cause radio interference. Install and use the equipment according to the instruction manual.

この装置は、情報処理装置等電波障害自主規制協議会（VCCI）の基準に基づくクラスB 情報技術装置です。この装置は、家庭環境で使用することを目的としていますが、この装置がラジオやテレビジョン受信機に近接して使用されると、受信障害を引き起こすことがあります。
取扱説明書に従って正しい取り扱いをして下さい。









Korean Class B statement translation: this is household equipment that is certified to comply with EMC requirements. You may use this equipment in residential environments and other non-residential environments.

이 기기는 가정용으로 전자파적합등록을 한 기기로서
주거지역에서는 물론 모든 지역에서 사용할 수 있습니다.

5.1.5 Product Certification Markings (Board Level)

Intel Desktop Board DP45SG has the product certification markings shown in Table 44:

Table 44. Product Certification Markings

| Description | Mark |
|--------------------------------------------------------------------------------------------------------------------------------------------------------------------------------------------------------------------------------------------------------------------------------------------------------------------------|---------------------------------------------------------------------------------------|
| UL joint US/Canada Recognized Component mark. Includes adjacent UL file number for Intel desktop boards: E210882. |  |
| FCC Declaration of Conformity logo mark for Class B equipment. Includes Intel name and DP45SG model designation. |  |
| CE mark. Declaring compliance to European Union (EU) EMC directive and Low Voltage directive. |  |
| Australian Communications Authority (ACA) and New Zealand Radio Spectrum Management (NZ RSM) C-tick mark. Includes adjacent Intel supplier code number, N-232. |  |
| Japan VCCI (Voluntary Control Council for Interference) mark. |  |
| S. Korea MIC (Ministry of Information and Communication) mark. Includes adjacent MIC certification number: CPU-DP45SG (B) |  |
| Taiwan BSMI (Bureau of Standards, Metrology and Inspections) mark. Includes adjacent Intel company number, D33025. |  |
| Printed wiring board manufacturer's recognition mark. Consists of a unique UL recognized manufacturer's logo, along with a flammability rating (solder side). | V-0 |
| China RoHS/Environmentally Friendly Use Period Logo: This is an example of the symbol used on Intel Desktop Boards and associated collateral. The color of the mark may vary depending upon the application. The Environmental Friendly Usage Period (EFUP) for Intel Desktop Boards has been determined to be 10 years. |  |

5.2 Battery Disposal Information



CAUTION

Risk of explosion if the battery is replaced with an incorrect type. Batteries should be recycled where possible. Disposal of used batteries must be in accordance with local environmental regulations.



PRECAUTION

Risque d'explosion si la pile usagée est remplacée par une pile de type incorrect. Les piles usagées doivent être recyclées dans la mesure du possible. La mise au rebut des piles usagées doit respecter les réglementations locales en vigueur en matière de protection de l'environnement.



FORHOLDSREGEL

Eksplussionsfare, hvis batteriet erstattes med et batteri af en forkert type. Batterier bør om muligt genbruges. Bortskaffelse af brugte batterier bør foregå i overensstemmelse med gældende miljølovgivning.



OBS!

Det kan oppstå eksplosjonsfare hvis batteriet skiftes ut med feil type. Brukte batterier bør kastes i henhold til gjeldende miljølovgivning.



VIKTIGT!

Risk för explosion om batteriet ersätts med felaktig batterityp. Batterier ska kasseras enligt de lokala miljövårdsbestämmelserna.



VARO

Räjähdyksvaara, jos pariston tyyppi on väärä. Paristot on kierrätettävä, jos se on mahdollista. Käytetyt paristot on hävitettävä paikallisten ympäristömääräysten mukaisesti.



VORSICHT

Bei falschem Einsetzen einer neuen Batterie besteht Explosionsgefahr. Die Batterie darf nur durch denselben oder einen entsprechenden, vom Hersteller empfohlenen Batterietyp ersetzt werden. Entsorgen Sie verbrauchte Batterien den Anweisungen des Herstellers entsprechend.



AVVERTIMENTO

Esiste il pericolo di un esplosione se la pila non viene sostituita in modo corretto. Utilizzare solo pile uguali o di tipo equivalente a quelle consigliate dal produttore. Per disfarsi delle pile usate, seguire le istruzioni del produttore.



PRECAUCIÓN

Existe peligro de explosión si la pila no se cambia de forma adecuada. Utilice solamente pilas iguales o del mismo tipo que las recomendadas por el fabricante del equipo. Para deshacerse de las pilas usadas, siga igualmente las instrucciones del fabricante.



WAARSCHUWING

Er bestaat ontploffingsgevaar als de batterij wordt vervangen door een onjuist type batterij. Batterijen moeten zoveel mogelijk worden gerecycled. Houd u bij het weggoaien van gebruikte batterijen aan de plaatselijke milieuwetgeving.



ATENÇÃO

Haverá risco de explosão se a bateria for substituída por um tipo de bateria incorreto. As baterias devem ser recicladas nos locais apropriados. A eliminação de baterias usadas deve ser feita de acordo com as regulamentações ambientais da região.



AŠCIAROŽZNAŚĆ

Існуе рызыка выбуху, калі заменены акумулятар неправильнага тыпу. Акумулятары павінны, па магчымасці, перепрацоўвацца. Пазбаўляцца ад старых акумулятараў патрэбна згодна з мясцовым заканадаўствам па экалогіі.



UPOZORNĚNÍ

V případě výměny baterie za nesprávný druh může dojít k výbuchu. Je-li to možné, baterie by měly být recyklovány. Baterie je třeba zlikvidovat v souladu s místními předpisy o životním prostředí.



Προσοχή

Υπάρχει κίνδυνος για έκρηξη σε περίπτωση που η μπαταρία αντικατασταθεί από μία λανθασμένου τύπου. Οι μπαταρίες θα πρέπει να ανακυκλώνονται όταν κάτι τέτοιο είναι δυνατό. Η απόρριψη των χρησιμοποιημένων μπαταριών πρέπει να γίνεται σύμφωνα με τους κατά τόπο περιβαλλοντικούς κανονισμούς.



VIGYAZAT

Ha a telepet nem a megfelelő típusú telepre cseréli, az felrobbanhat. A telepeket lehetőség szerint újra kell hasznosítani. A használt telepeket a helyi környezetvédelmi előírásoknak megfelelően kell kiselejtezni.



注意

異なる種類の電池を使用すると、爆発の危険があります。リサイクルが可能な地域であれば、電池をリサイクルしてください。使用後の電池を破棄する際には、地域の環境規制に従ってください。



AWAS

Risiko letupan wujud jika bateri digantikan dengan jenis yang tidak betul. Bateri sepatutnya dikitar semula jika boleh. Pelupusan bateri terpakai mestilah mematuhi peraturan alam sekitar tempatan.



OSTRZEŻENIE

Istnieje niebezpieczeństwo wybuchu w przypadku zastosowania niewłaściwego typu baterii. Zużyte baterie należy w miarę możliwości utylizować zgodnie z odpowiednimi przepisami ochrony środowiska.



PRECAUȚIE

Risc de explozie, dacă bateria este înlocuită cu un tip de baterie necorespunzător. Bateriile trebuie reciclate, dacă este posibil. Depozitarea bateriilor uzate trebuie să respecte reglementările locale privind protecția mediului.



ВНИМАНИЕ

При использовании батареи несоответствующего типа существует риск ее взрыва. Батареи должны быть утилизированы по возможности. Утилизация батарей должна проводиться по правилам, соответствующим местным требованиям.



UPOZORNENIE

Ak batériu vymeníte za nesprávny typ, hrozí nebezpečenstvo jej výbuchu. Batérie by sa mali podľa možnosti vždy recyklovať. Likvidácia použitých batérií sa musí vykonávať v súlade s miestnymi predpismi na ochranu životného prostredia.



POZOR

Zamenjava baterije z baterijo drugačnega tipa lahko povzroči eksplozijo. Če je mogoče, baterije reciklirajte. Rabljene baterije zavržite v skladu z lokalnimi okoljevarstvenimi predpisi.



คำเตือน

ระวังการระเบิดที่เกิดจากเปลี่ยนแบตเตอรี่ผิดประเภท หากเป็นไปได้ ควรนำแบตเตอรี่ไปรีไซเคิล การทิ้งแบตเตอรี่ใช้แล้วต้องเป็นไปตามกฎข้อบังคับด้านสิ่งแวดล้อมของท้องถิ่น.



UYARI

Yanlış türde pil takıldığında patlama riski vardır. Piller mümkün olduğunda geri dönüştürülmelidir. Kullanılmış piller, yerel çevre yasalarına uygun olarak atılmalıdır.



ОСТОРОГА

Використовуйте батареї правильного типу, інакше існуватиме ризик вибуху. Якщо можливо, використані батареї слід утилізувати. Утилізація використаних батарей має бути виконана згідно місцевих норм, що регулюють охорону довкілля.



UPOZORNĚNÍ

V případě výměny baterie za nesprávný druh může dojít k výbuchu. Je-li to možné, baterie by měly být recyklovány. Baterie je třeba zlikvidovat v souladu s místními předpisy o životním prostředí.



ETTEVAATUST

Kui patarei asendatakse uue ebasobivat tüüpi patareiga, võib tekkida plahvatusoht. Tühjad patareid tuleb võimaluse korral viia vastavasse kogumispunkti. Tühjade patareide äraviskamisel tuleb järgida kohalikke keskkonnakaitse alaseid reegleid.



FIGYELMEZTETÉS

Ha az elemet nem a megfelelő típusúra cseréli, felrobbanhat. Az elemeket lehetőség szerint újra kell hasznosítani. A használt elemeket a helyi környezetvédelmi előírásoknak megfelelően kell kiselejtezni.



UZMANĪBU

Pastāv eksplozijas risks, ja baterijas tiek nomainītas ar nepareiza veida baterijām. Ja iespējams, baterijas vajadzētu nodot attiecīgos pieņemšanas punktus. Bateriju izmešanai atkritumos jānotiek saskaņā ar vietējiem vides aizsardzības noteikumiem.



DĒMESIO

Naudojant netinkamo tipo baterijas įrenginys gali sprogti. Kai tik įmanoma, baterijas reikia naudoti pakartotinai. Panaudotas baterijas išmesti būtina pagal vietinius aplinkos apsaugos nuostatus.



ATTENZJONI

Riskju ta' splużjoni jekk il-batterija tinbidel b'tip ta' batterija mhux korrett. Il-batteriji għandhom jiġu riċiklati fejn hu possibbli. Ir-rimi ta' batteriji użati għandu jsir skond ir-regolamenti ambjentali lokali.



OSTRZEŻENIE

Ryzyko wybuchu w przypadku wymiany na baterie niewłaściwego typu. W miarę możliwości baterie należy poddać recyklingowi. Zużytych baterii należy pozbywać się zgodnie z lokalnie obowiązującymi przepisami w zakresie ochrony środowiska.