

PRELIMINARY SPEC

Features

- BUILT-IN CURRENT LIMITING RESISTOR FOR DIRECT APPLICATION OF DIFFERENT ACROSS CURRENT.
- LONG LIFE.
- LOW CURRENT, POWER SAVINGS.
- LOW MAINTENANCE.
- DIFFERENT COLOR AVAILABLE.
- SOLID STATE, HIGH VIBRATION RESISTANT.
- 6V INTERNAL RESISTOR.
- RoHS COMPLIANT.



Notes:

1. All dimensions are in millimeters (inches).
2. Tolerance is $\pm 0.25(0.01)$ " unless otherwise noted.
3. Specifications are subject to change without notice.

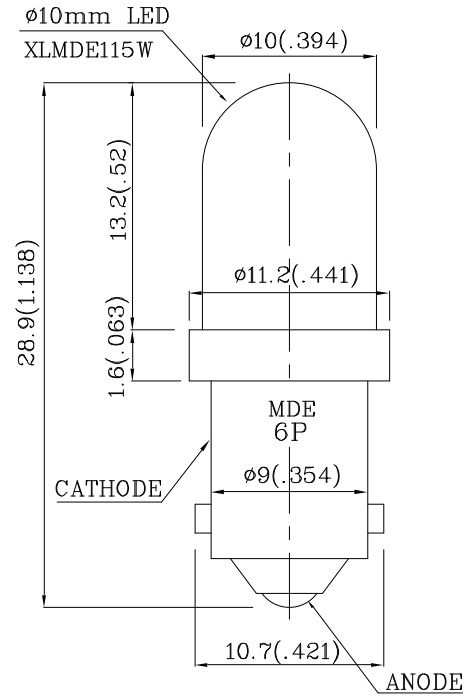

Absolute Maximum Ratings (TA=25°C)		MDE (InGaAlP)	Unit
Reverse Voltage	VR	5	V
Forward Voltage	VF	7	V
Power Dissipation	PT	175	mW
Operating Temperature	TA	-40 ~ +70	°C
Storage Temperature	Tstg	-40 ~ +85	

Operating Characteristics (TA=25°C)		MDE (InGaAlP)	Unit
Forward Current (Typ.) (VF=6V)	IF	20	mA
Forward Current (Max.) (VF=6V)	IF	25	mA
Reverse Current (Max.) (VR=5V)	IR	10	uA
Wavelength Of Peak Emission (Typ.) (VF=6V)	λ P	640	nm
Wavelength Of Dominant Emission (Typ.) (VF=6V)	λ D	630	nm
Spectral Line Full Width At Half-Maximum (Typ.) (VF=6V)	Δλ	25	nm

Part Number	Emitting Color	Emitting Material	Lens-color	Luminous Intensity (V=6V) mcd		Wavelength nm λ P	Viewing Angle 2 θ 1/2
				min.	typ.		
XYMDE101W6V	Red	InGaAlP	Water Clear	1800	3290	640	20°

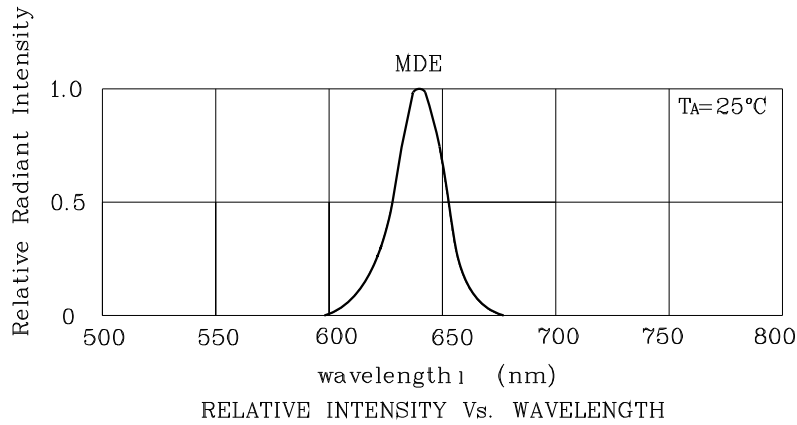

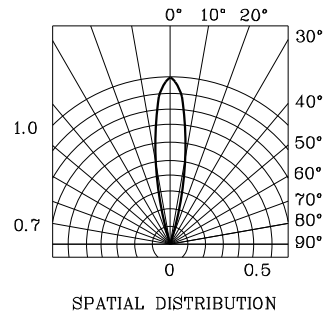
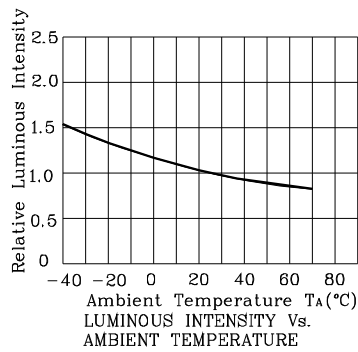
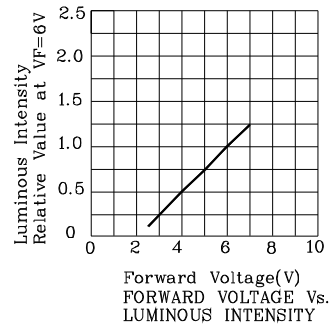
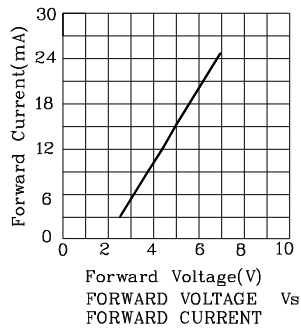

❖ MD-E

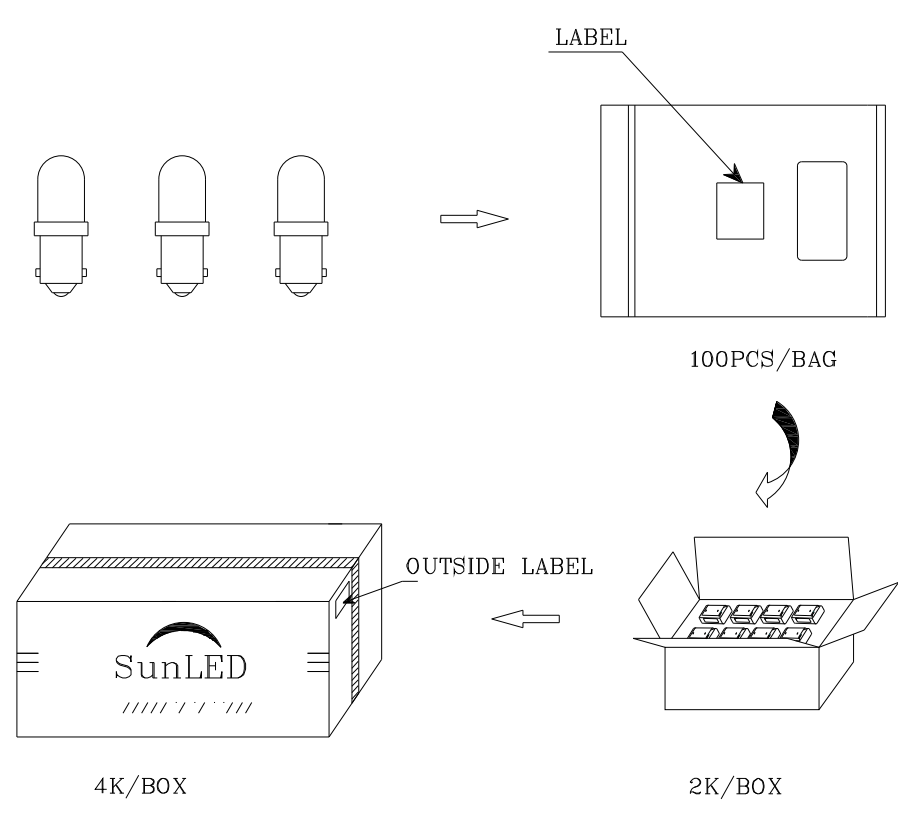

PACKING & LABEL SPECIFICATIONS

XYMDE101W6V

P/NO : XYxxx102x	
QTY : 100 pcs	CODE: XXX
S/N : XX	
LOT NO :	
 XXXXXXXXXXXXXXXXXXXXXXXX	
RoHS Compliant	