

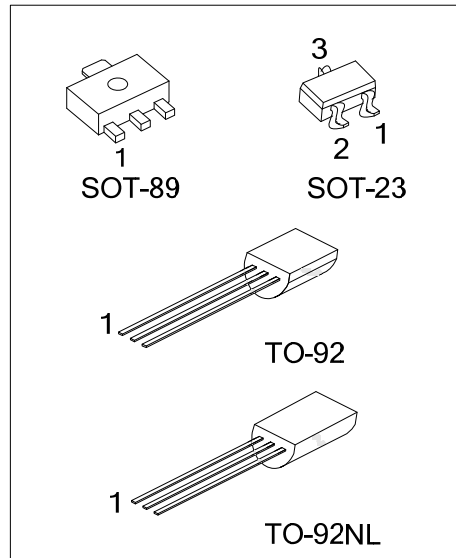

HE8550

PNP SILICON TRANSISTOR

LOW VOLTAGE HIGH
CURRENT SMALL SIGNAL PNP
TRANSISTOR



■ DESCRIPTION

The UTC **HE8550** is a low voltage high current small signal PNP transistor, designed for Class B push-pull 2W audio amplifier for portable radio and general purpose applications.

■ FEATURES

- * Collector Current up to 1.5A
- * Collector-Emitter Voltage up to 25 V
- * Complimentary to UTC **HE8050**

■ ORDERING INFORMATION

Ordering Number			Package	Pin Assignment			Packing
Normal	Lead Free	Halogen Free		1	2	3	
HE8550-x-AB3-R	HE8550L-x-AB3-R	HE8550G-x-AB3-R	SOT-89	B	C	E	Tape Reel
HE8550-x-AE3-R	HE8550L-x-AE3-R	HE8550G-x-AE3-R	SOT-23	E	B	C	Tape Reel
HE8550-x-T92-B	HE8550L-x-T92-B	HE8550G-x-T92-B	TO-92	E	C	B	Tape Box
HE8550-x-T92-K	HE8550L-x-T92-K	HE8550G-x-T92-K	TO-92	E	C	B	Bulk
HE8550-x-T9N-B	HE8550L-x-T9N-B	HE8550G-x-T9N-B	TO-92NL	E	C	B	Tape Box
HE8550-x-T9N-K	HE8550L-x-T9N-K	HE8550G-x-T9N-K	TO-92NL	E	C	B	Bulk

<p>HE8550L-x-AE3-R</p>	<p>(1) B: Tape Box, K: Bulk, R: Tape Reel</p> <p>(2) AB3: SOT-89, AE3: SOT-23, T92: TO-92, T9N: TO-92NL</p> <p>(3) x: refer to Classification of h_{FE2}</p> <p>(4) G: Halogen Free, L: Lead Free, Blank: Pb/Sn</p>
------------------------	--

■ MARKING(For SOT-23 Package)

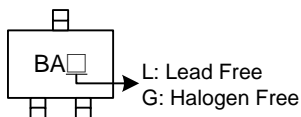

■ ABSOLUTE MAXIMUM RATING (Ta=25°C, unless otherwise specified)

PARAMETER		SYMBOL	RATINGS	UNIT
Collector-Base Voltage		V_{CBO}	-40	V
Collector-Emitter Voltage		V_{CEO}	-25	V
Emitter-Base Voltage		V_{EBO}	-6	V
Collector Dissipation	SOT-23	P_C	350	mW
	SOT-89		0.5	W
	TO-92/TO-92NL		1	W
Collector Current		I_C	-1.5	A
Junction Temperature		T_J	+150	°C
Storage Temperature		T_{STG}	-65 ~ +150	°C

Note Absolute maximum ratings are those values beyond which the device could be permanently damaged. Absolute maximum ratings are stress ratings only and functional device operation is not implied.

■ ELECTRICAL CHARACTERISTICS (Ta=25°C, unless otherwise specified)

PARAMETER	SYMBOL	TEST CONDITIONS	MIN	TYP	MAX	UNIT
Collector-Base Breakdown Voltage	BV_{CBO}	$I_C=-100\mu A, I_E=0$	-40			V
Collector-Emitter Breakdown Voltage	BV_{CEO}	$I_C=-2mA, I_B=0$	-25			V
Emitter-Base Breakdown Voltage	BV_{EBO}	$I_E=-100\mu A, I_C=0$	-6			V
Collector Cut-Off Current	I_{CBO}	$V_{CB}=-35V, I_E=0$			-100	nA
Emitter Cut-Off Current	I_{EBO}	$V_{EB}=-6V, I_C=0$			-100	nA
DC Current Gain	h_{FE1}	$V_{CE}=-1V, I_C=-5mA$	45	170		
	h_{FE2}	$V_{CE}=-1V, I_C=-100mA$	85	160	500	
	h_{FE3}	$V_{CE}=-1V, I_C=-800mA$	40	80		
Collector-Emitter Saturation Voltage	$V_{CE(SAT)}$	$I_C=-800mA, I_B=-80mA$		-0.28	-0.5	V
Base-Emitter Saturation Voltage	$V_{BE(SAT)}$	$I_C=-800mA, I_B=-80mA$		-0.98	-1.2	V
Base-Emitter Voltage	V_{BE}	$V_{CE}=-1V, I_C=-10mA$		-0.66	-1.0	V
Current Gain Bandwidth Product	f_T	$V_{CE}=-10V, I_C=-50mA$	100	190		MHz
Output Capacitance	C_{ob}	$V_{CB}=-10V, I_E=0 f=1MHz$		9.0		pF

■ CLASSIFICATION OF h_{FE2}

RANK	C	D	E
RANGE	120-200	160-300	250-500

■ TYPICAL CHARACTERISTICS

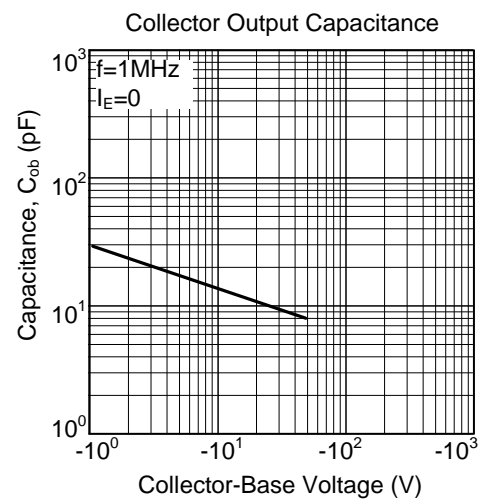
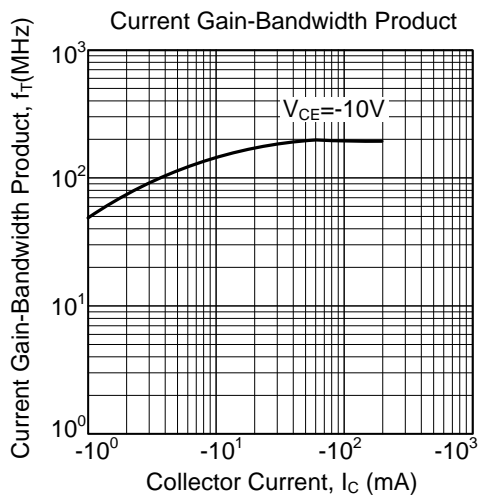
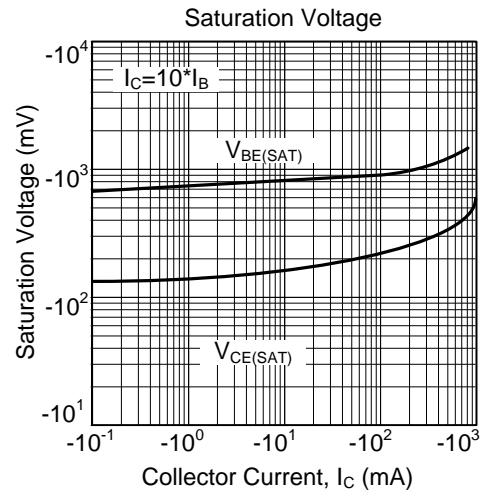
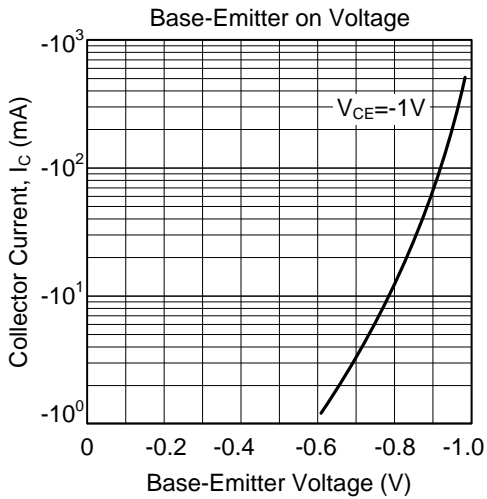
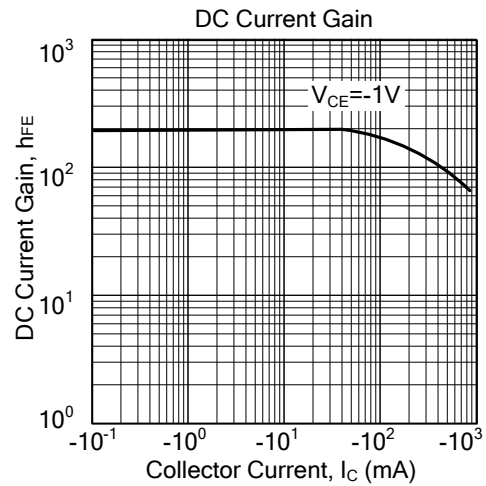
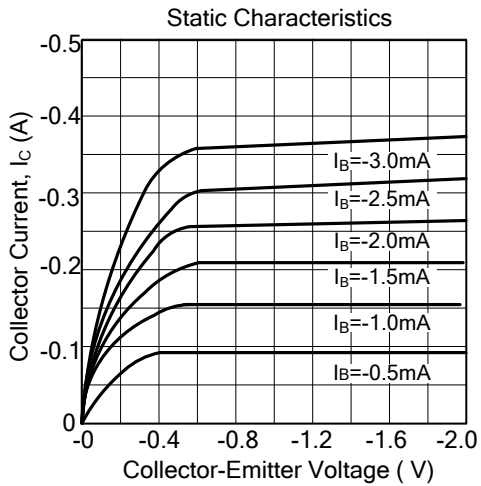

■ TYPICAL CHARACTERISTICS

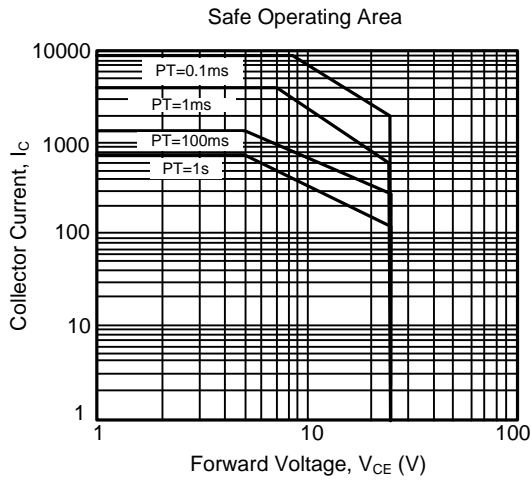

UTC assumes no responsibility for equipment failures that result from using products at values that exceed, even momentarily, rated values (such as maximum ratings, operating condition ranges, or other parameters) listed in products specifications of any and all UTC products described or contained herein. UTC products are not designed for use in life support appliances, devices or systems where malfunction of these products can be reasonably expected to result in personal injury. Reproduction in whole or in part is prohibited without the prior written consent of the copyright owner. The information presented in this document does not form part of any quotation or contract, is believed to be accurate and reliable and may be changed without notice.