

RF & MICROWAVE TRANSISTORS 1.6 GHz SATCOM APPLICATIONS

- 1.65 GHz
- 28 VOLTS
- OVERLAY DIE GEOMETRY
- ALL GOLD METALLIZED SYSTEM
- HIGH RELIABILITY AND RUGGEDNESS
- COMMON BASE
- $P_{OUT} = 15$ W MIN. WITH 9.2 dB GAIN

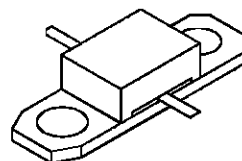

.250 x .320 2LFL (M170)
epoxy sealed

ORDER CODE

SD1895-03

BRANDING

SD1895-3

PIN CONNECTION

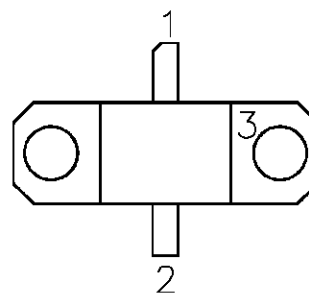

1. Collector

2. Emitter

3. Base

DESCRIPTION

The SD1895-03 is a 28 V silicon NPN planar transistor designed for INMARSAT and other 1.6 GHz SATCOM applications. This device utilizes polysilicon site ballasting with a gold metallized die to achieve high reliability and ruggedness.

ABSOLUTE MAXIMUM RATINGS ($T_{case} = 25^{\circ}C$)

Symbol	Parameter	Value	Unit
V_{CBO}	Collector-Base Voltage	45	V
V_{CEO}	Collector-Emitter Voltage	15	V
V_{EBO}	Emitter-Base Voltage	3.0	V
I_C	Device Current	3.0	A
P_{DISS}	Power Dissipation	37.2	W
T_J	Junction Temperature	+200	$^{\circ}C$
T_{STG}	Storage Temperature	- 65 to +150	$^{\circ}C$

THERMAL DATA

$R_{TH(j-c)}$	Junction-Case Thermal Resistance	4.7	$^{\circ}C/W$
---------------	----------------------------------	-----	---------------

SD1895-03**ELECTRICAL SPECIFICATIONS** ($T_{\text{case}} = 25^{\circ}\text{C}$)

STATIC

Symbol	Test Conditions		Value			Unit
			Min.	Typ.	Max.	
BV_{CBO}	$I_{\text{C}} = 5 \text{ mA}$	$I_{\text{E}} = 0 \text{ mA}$	45	—	—	V
BV_{CEO}	$I_{\text{C}} = 5 \text{ mA}$	$I_{\text{B}} = 0 \text{ mA}$	12	—	—	V
BV_{EBO}	$I_{\text{E}} = 5 \text{ mA}$	$I_{\text{C}} = 0 \text{ mA}$	3.0	—	—	V
h_{FE}	$V_{\text{CE}} = 5 \text{ V}$	$I_{\text{C}} = 1 \text{ A}$	15	—	150	—

DYNAMIC

Symbol	Test Conditions			Value			Unit
				Min.	Typ.	Max.	
P_{OUT}	$f = 1.65 \text{ GHz}$	$P_{\text{IN}} = 2.4 \text{ W}$	$V_{\text{CE}} = 28 \text{ V}$	20	—	—	W
G_{P}	$f = 1.65 \text{ GHz}$	$P_{\text{IN}} = 2.4 \text{ W}$	$V_{\text{CE}} = 28 \text{ V}$	9.2	—	—	dB
η_{c}	$f = 1.65 \text{ GHz}$	$P_{\text{IN}} = 2.4 \text{ W}$	$V_{\text{CE}} = 28 \text{ V}$	48	—	—	%

TYPICAL PERFORMANCE

POWER OUTPUT vs POWER INPUT

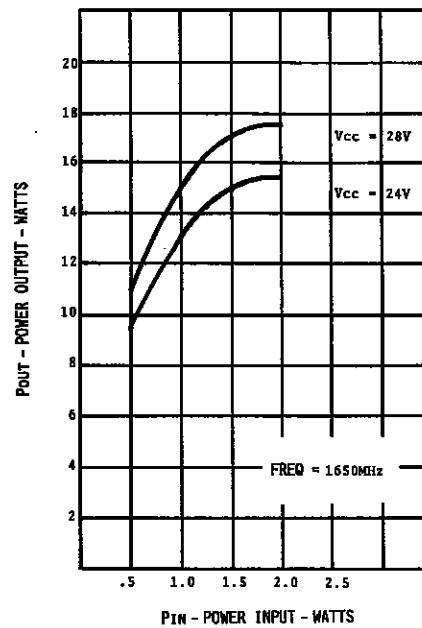

IMPEDANCE DATA

FREQ.	$Z_{\text{IN}} (\Omega)$	$Z_{\text{CL}} (\Omega)$
1.65 GHz	$17.0 + j 18.0$	$3.5 - j 2.0$

TEST CIRCUIT

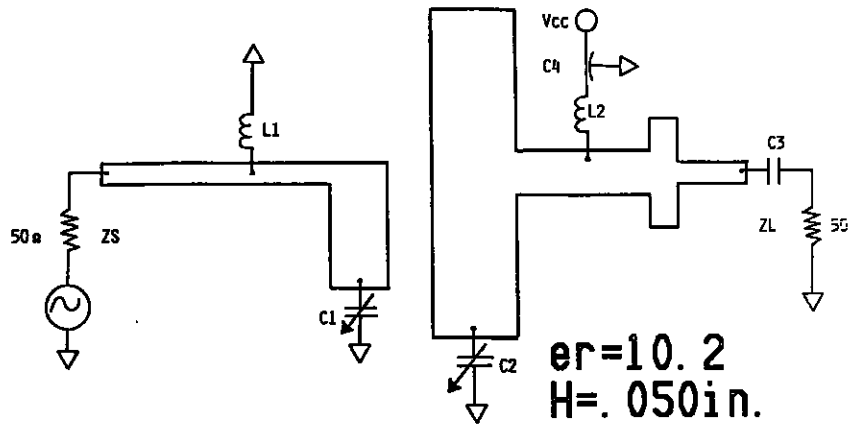

- C1, C2 : 0.4 - 2.5pF #27283 Johanson Trimmer
- C3 : 100pF ATC 100A101KCA150 Chip Capacitor
- C4 : 15,000pF EMI Filter Murata/Erie #9900-381-6004
- L1, L2 : 4 Turns, #28 AWG. .080" I.D.

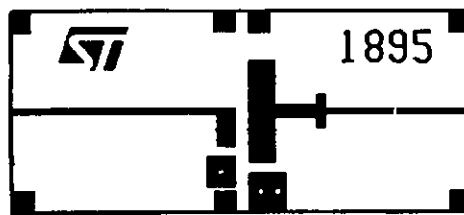
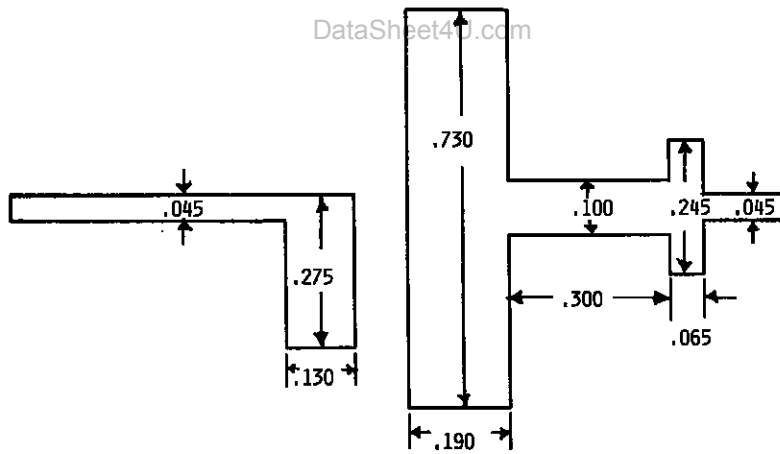

et4U.com

DataShee

DataSheet4U.com

DataSheet4U.com

www.DataSheet4U.com

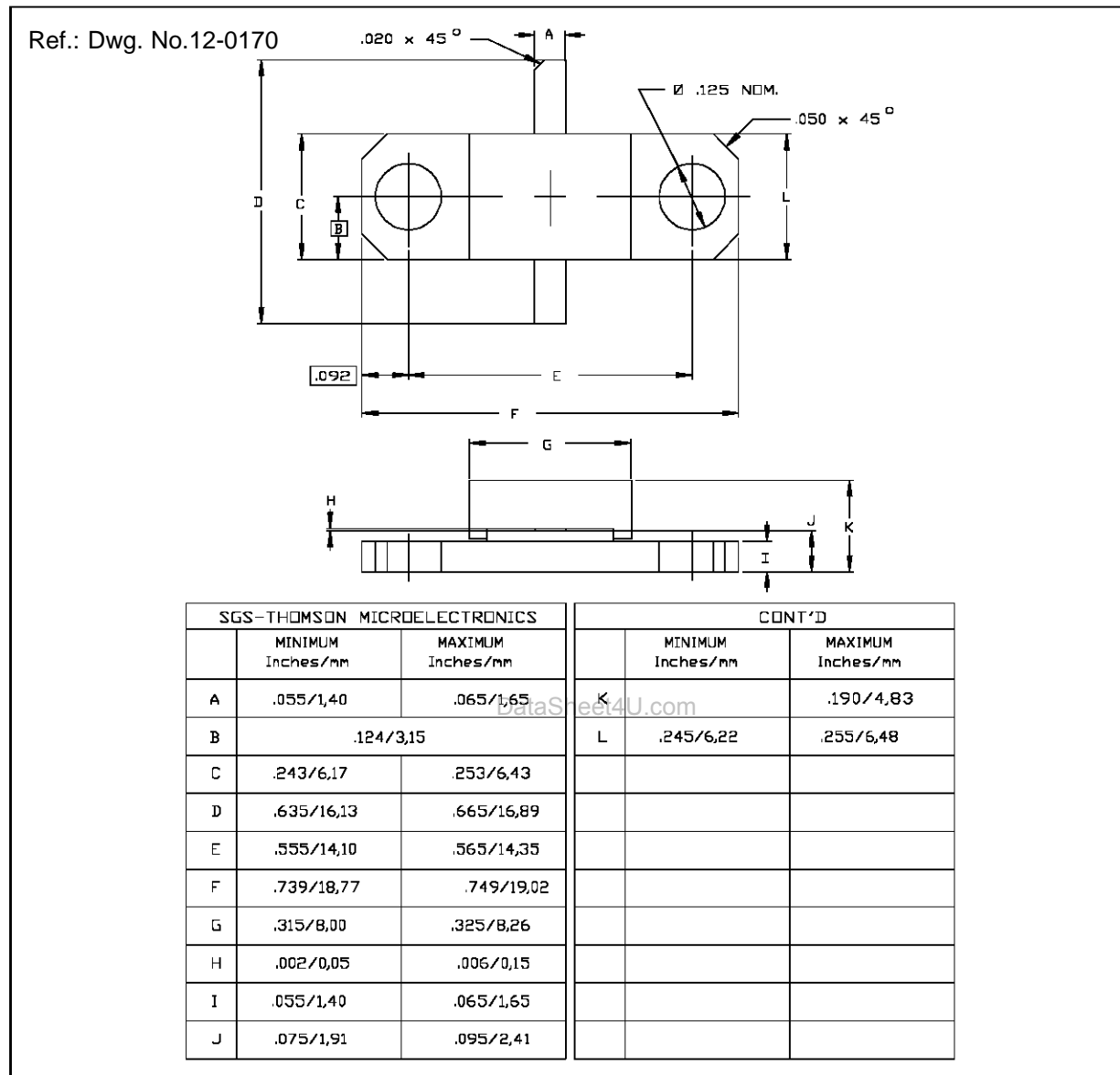
SD1895-03**PACKAGE MECHANICAL DATA**

Information furnished is believed to be accurate and reliable. However, SGS-THOMSON Microelectronics assumes no responsibility for the consequences of use of such information nor for any infringement of patents or other rights of third parties which may result from its use. No license is granted by implication or otherwise under any patent or patent rights of SGS-THOMSON Microelectronics. Specifications mentioned in this publication are subject to change without notice. This publication supersedes and replaces all information previously supplied. SGS-THOMSON Microelectronics products are not authorized for use as critical components in life support devices or systems without express written approval of SGS-THOMSON Microelectronics.

© 1994 SGS-THOMSON Microelectronics - All Rights Reserved

SGS-THOMSON Microelectronics GROUP OF COMPANIES
Australia - Brazil - France - Germany - Hong Kong - Italy - Japan - Korea - Malaysia - Malta - Morocco - The Netherlands -
Singapore - Spain - Sweden - Switzerland - Taiwan - Thailand - United Kingdom - U.S.A