

THIS DRAWING IS UNPUBLISHED. RELEASED FOR PUBLICATION. ALL RIGHTS RESERVED.

LOC H DIST -

REVISIONS

P	LTR	DESCRIPTION	DATE	DWN	APVD
	S3	APPLICATION SPECIFICATION NUMBER ADDED	24JUL2013	KJK	RP

REFERENCE MATING INTERFACE PATTERN:
1,27 STAGGERED PITCH x 1,5 ROW-DISTANCE.

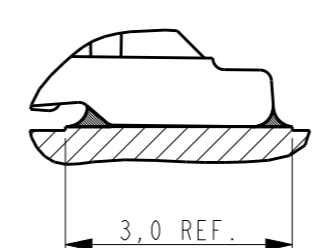
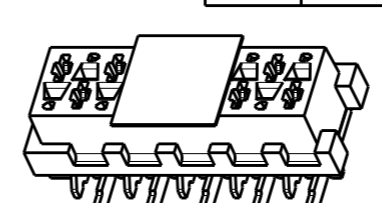
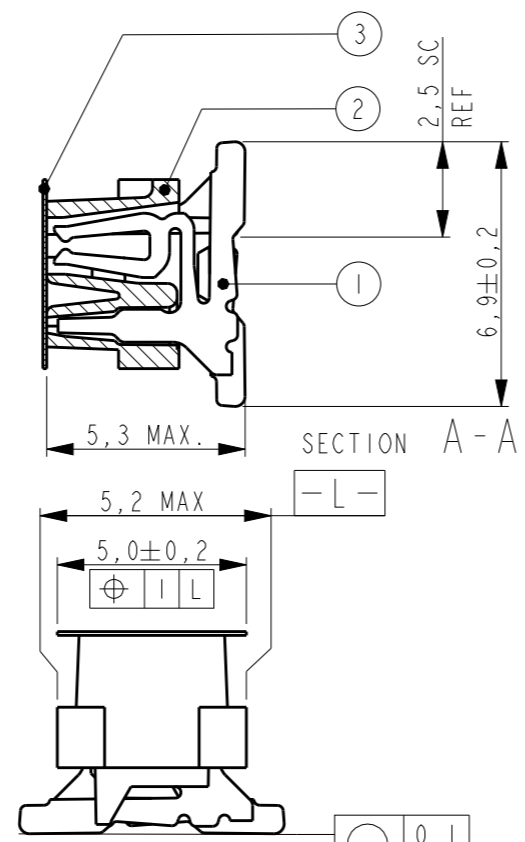
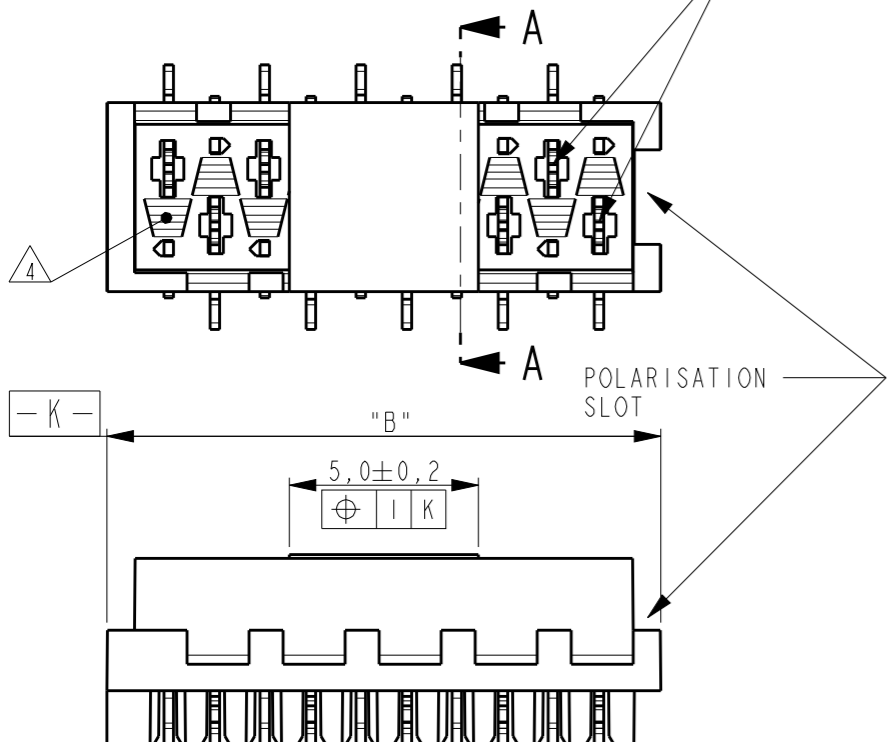

1	PARTNUMBER VAC. TAPE.	3	PARTNUMBER	NR. OF POS. "n"	"A"	"B" MAX.
	7-188275-4		0-188275-4	4	3,81	7,1
	7-188275-6		0-188275-6	6	6,35	9,7
	7-188275-8		0-188275-8	8	8,89	12,2
	8-188275-0		1-188275-0	10	11,43	14,7
	8-188275-2		1-188275-2	12	13,97	17,3
	8-188275-4		1-188275-4	14	16,51	19,8
	8-188275-6		1-188275-6	16	19,05	22,4
	8-188275-8		1-188275-8	18	21,59	24,9
	9-188275-0		2-188275-0	20	24,13	27,5

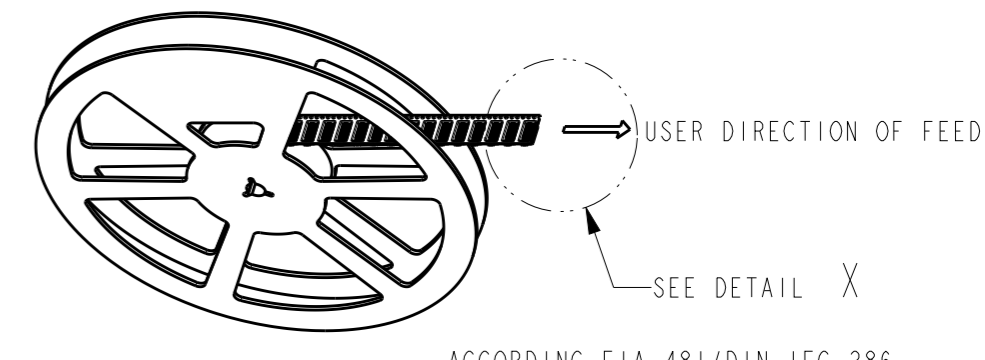
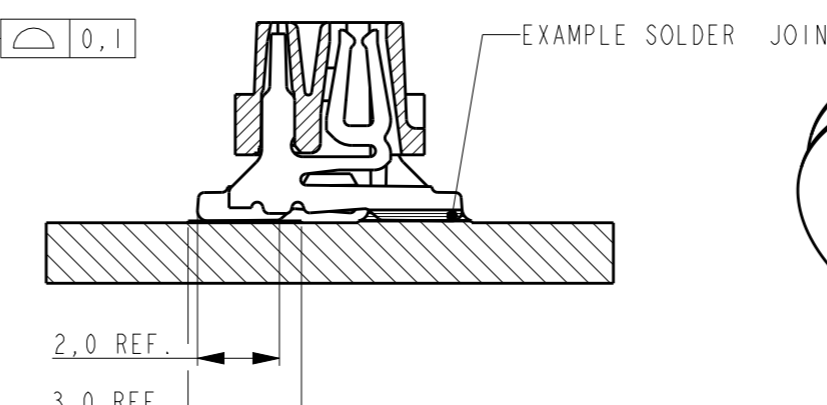
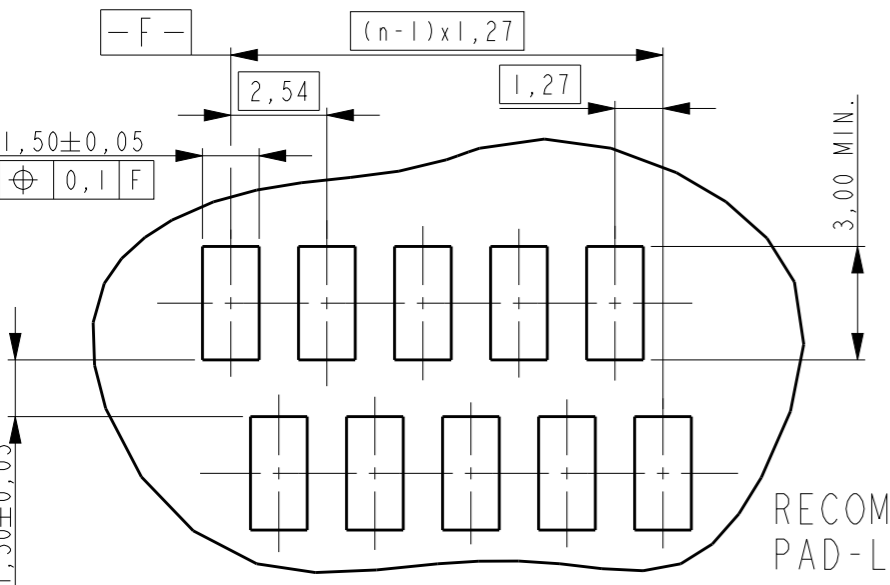
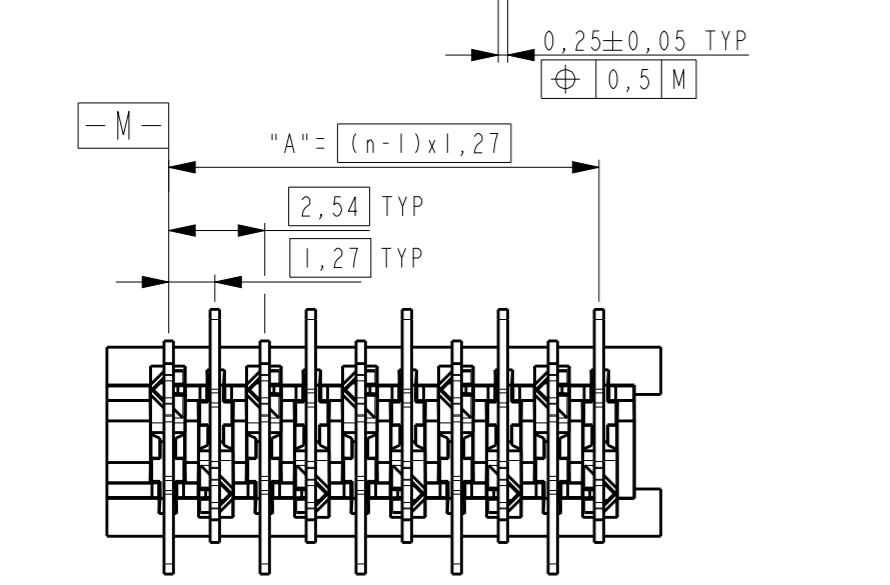

- NOTES:
- 1 TAPE FOR VACUUM P&P ONLY FOR DASHNUMBERS 7- /8- /9-
 - 2 FOR PACKAGING SEE SHEET 2 OF 2
 - 3 WITHOUT VACUUM TAPE.
 - 4 CORING-OUTS FOR MANUFACTURING PURPOSE ONLY. SHAPE MAY VARY, BUT IS NOT FUNCTIONAL FOR THE APPLICATION.
 - 5 SHOWN IS A 10 POSITION CONNECTOR.

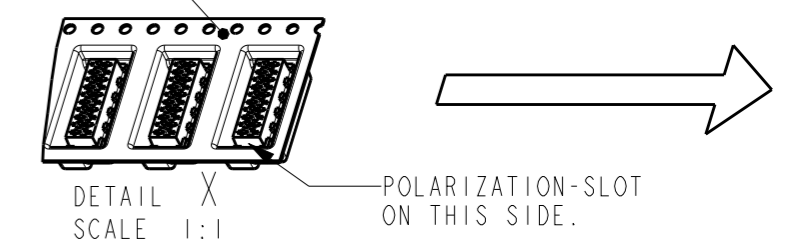

ITEM NO.	COMPONENT DESCRIPTION	MATERIAL	FINISH / COLOR
3	PICK & PLACE TAPE	KAPTON	AMBER TRANSPARENT
2	FEMALE HOUSING	POLYAMIDE 4/6,GF	RED
1	FEMALE CONTACT	PHOSPHOR BRONZE	TIN OVER NICKEL

THIS DRAWING IS A CONTROLLED DOCUMENT.		DWN M. GOSSELINK	TE Connectivity	
DIMENSIONS: mm		CHK -		
TOLERANCES UNLESS OTHERWISE SPECIFIED:		APVD -	NAME	
0 PLC ±-		PRODUCT SPEC 108-19052	CONNECTOR, FEMALE-ON-BOARD TOP-ENTRY, SMD, Micro-MatCh	
1 PLC ±-		APPLICATION SPEC 114-13318	SIZE A3	CAGE CODE 00779
2 PLC ±-		MATERIAL SEE TABLE	DRAWING NO C=188275	RESTRICTED TO -
3 PLC ±-		FINISH SEE TABLE	SCALE 5:1	SHEET 1 OF 2
4 PLC ±-				REV S3
ANGLES ±-				
CUSTOMER DRAWING				

THIS DRAWING IS UNPUBLISHED.

RELEASED FOR PUBLICATION

© COPYRIGHT -

ALL RIGHTS RESERVED.

LOC	DIST	REVISIONS					
H	-	P	LTR	DESCRIPTION	DATE	DWN	APVD
				SEE SHEET 1			

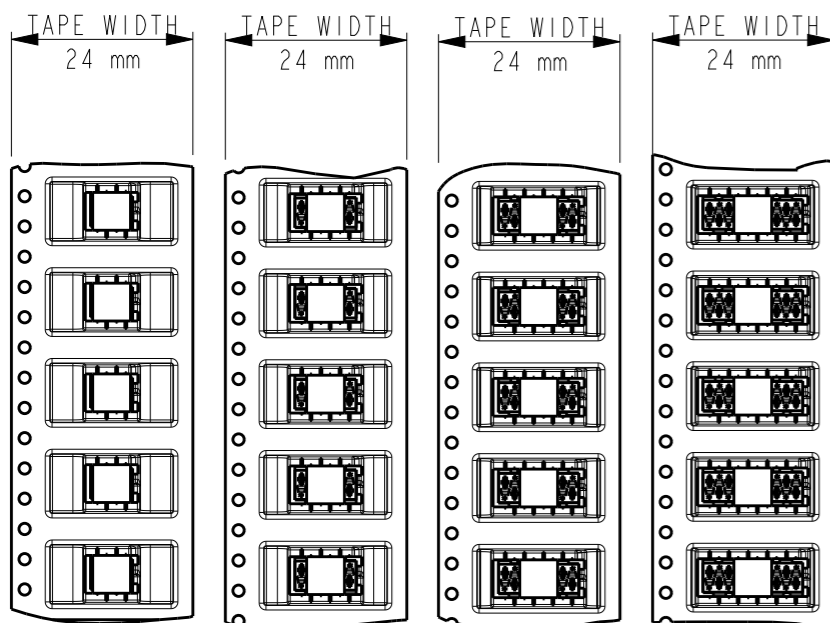

7-188275-4	7-188275-6	7-188275-8	8-188275-0
4 POSITION	6 POSITION	8 POSITION	10 POSITION
0-188275-4	0-188275-6	0-188275-8	1-188275-0

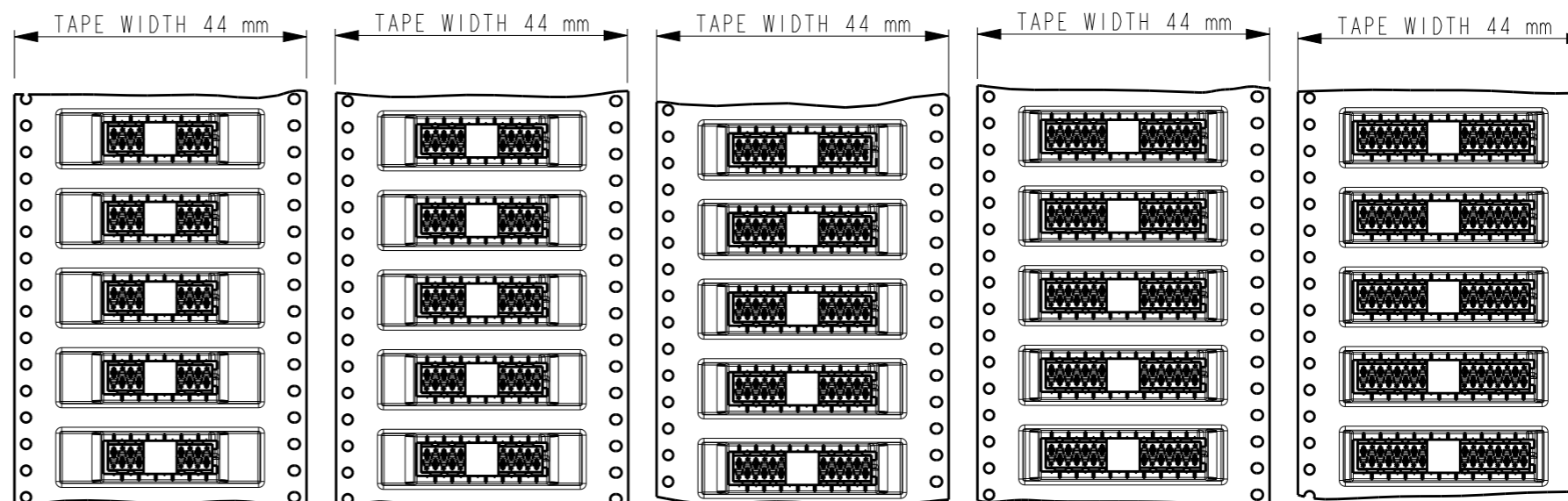
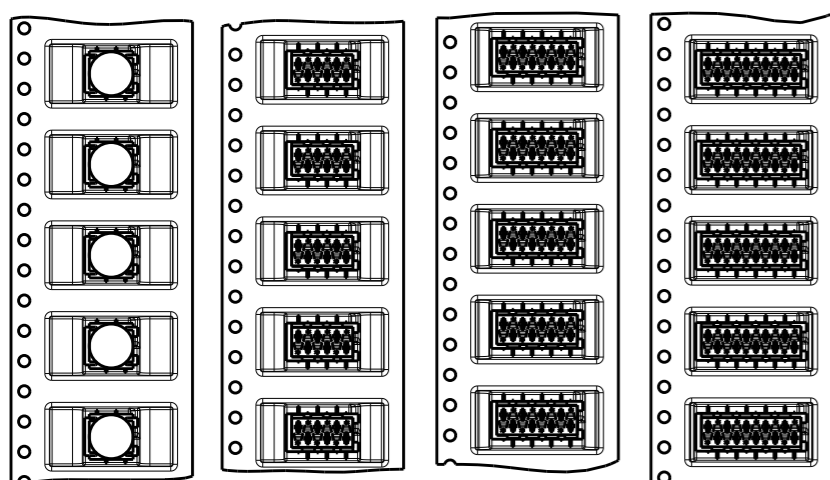

8-188275-2	8-188275-4	8-188275-6	8-188275-8	9-188275-0
12 POSITION	14 POSITION	16 POSITION	18 POSITION	20 POSITION
1-188275-2	1-188275-4	1-188275-6	1-188275-8	2-188275-0

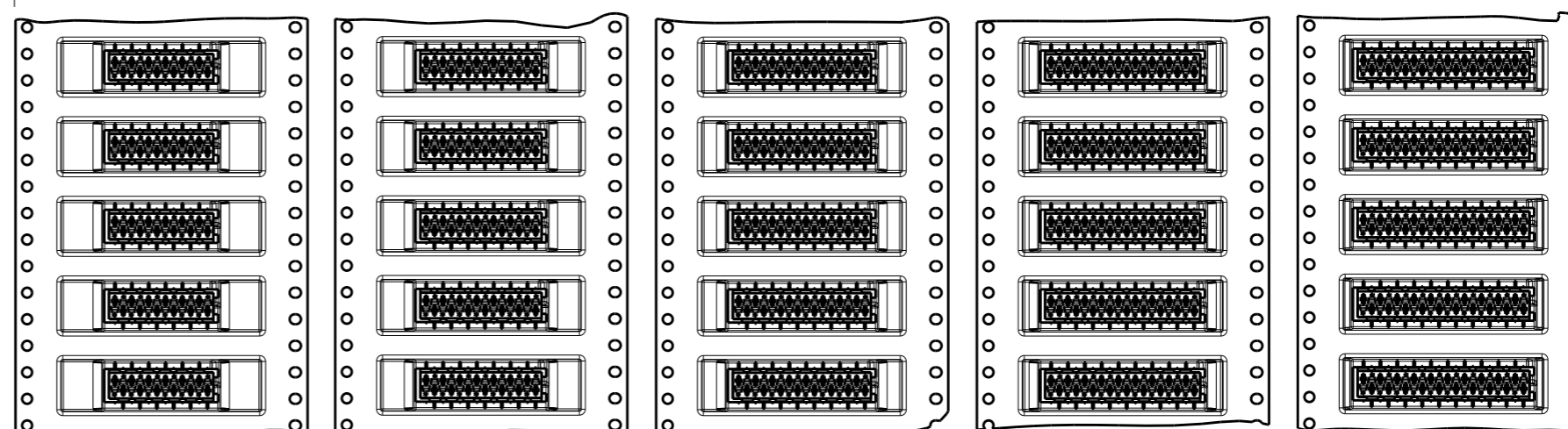

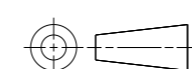
THIS DRAWING IS A CONTROLLED DOCUMENT.		DWN M. GOSSELINK	 TE Connectivity		
DIMENSIONS: mm		CHK -			
		APVD -	NAME CONNECTOR, FEMALE-ON-BOARD TOP-ENTRY, SMD, Micro-MaTch		
TOLERANCES UNLESS OTHERWISE SPECIFIED:		PRODUCT SPEC 108-19052	RESTRICTED TO		
0 PLC ±-		APPLICATION SPEC 114-13318	SIZE A3	CAGE CODE 00779	DRAWING NO C-188275
1 PLC ±0.1		WEIGHT -	SCALE 1:1		
2 PLC ±0.05		CUSTOMER DRAWING	SHEET 2 OF 2		
3 PLC ±-			REV S3		
4 PLC ±-					
ANGLES ±-					
FINISH -					