



# MDS35 / 50 / 80 Series

## DIODE / SCR MODULE

### MAIN FEATURES:

Symbol	Value	Unit
$I_{T(RMS)}$	50-70-85	A
$V_{DRM}/V_{RRM}$	800 and 1200	V
$I_{GT}$	50 and 100	mA

### DESCRIPTION

Packaged in ISOTOP modules, the MDS Series is based on the half-bridge SCR-diode configuration. They are suitable for high power applications, using phase controlled bridges, such as soft-start circuits, welding equipment, motor speed controller. The compactness of the ISOTOP package allows high power density and optimized power bus connections. Thanks to their internal ceramic pad, they provide high voltage insulation (2500V RMS), complying with UL standards (File ref: E81734).

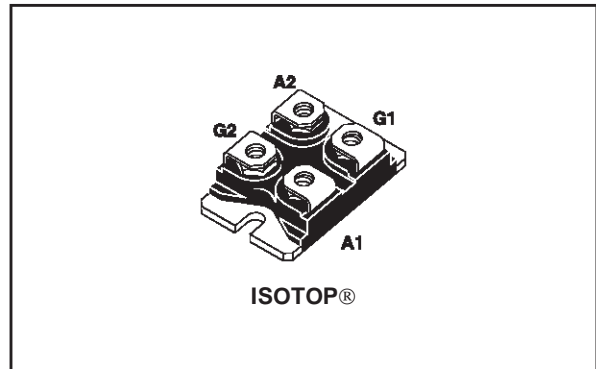

### PIN CONNECTIONS

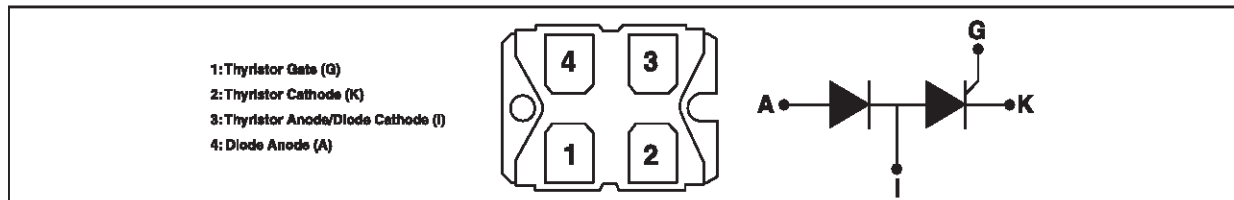

### ABSOLUTE RATINGS (limiting values)

Symbol	Parameter	Value			Unit		
		35	50	80			
$I_{T(RMS)}$	RMS on-state current	50	70	85	A		
$I_{T(AV)}$	Average on-state current (Single phase-circuit, 180° conduction angle per device)	T <sub>c</sub> = 85°C		25	35	55	A
$I_{TSM}$	Non repetitive surge peak on-state current (T <sub>j</sub> initial = 25°C)	tp = 8.3 ms	T <sub>j</sub> = 25°C	420	630	730	A
$I_{FSM}$				tp = 10 ms	400	600	
I t	I t Value for fusing	tp = 10 ms	T <sub>j</sub> = 25°C	800	1800	2450	A <sup>2</sup> s
di/dt	Critical rate of rise of on-state current I <sub>G</sub> = 2 x I <sub>GT</sub> , tr ≤ 100 ns	F = 60 Hz	T <sub>j</sub> = 125°C	50			A/μs
I <sub>GM</sub>	Peak gate current	tp = 20 μs	T <sub>j</sub> = 125°C	4			A
P <sub>G(AV)</sub>	Average gate power dissipation	T <sub>j</sub> = 125°C		1			W
T <sub>stg</sub>	Storage junction temperature range				- 40 to + 150		°C
T <sub>j</sub>	Operating junction temperature range				- 40 to + 125		
V <sub>RGM</sub>	Maximum peak reverse SCR gate voltage				5		V

ISOTOP is a registered trademark of STMicroelectronics

## MDS35 / 50 / 80 Series

### ELECTRICAL CHARACTERISTICS (T<sub>j</sub> = 25°C, unless otherwise specified)

#### SCR

Symbol	Test Conditions			MDS			Unit	
				35	50	80		
I <sub>GT</sub>	V <sub>D</sub> = 12 V    R <sub>L</sub> = 30 Ω			MIN.	5	10	mA	
				MAX.	50	100		
V <sub>GT</sub>				MAX.	1.3		V	
V <sub>GD</sub>	V <sub>D</sub> = V <sub>DRM</sub>	R <sub>L</sub> = 3.3 kΩ	T <sub>j</sub> = 125°C	MIN.	0.2		V	
I <sub>H</sub>	I <sub>T</sub> = 500 mA    Gate open			MAX.	80		mA	
I <sub>L</sub>	I <sub>G</sub> = 1.2 I <sub>GT</sub>			MAX.	120		mA	
dV/dt	V <sub>D</sub> = 67% V <sub>DRM</sub>	Gate open	T <sub>j</sub> = 125°C	MIN.	1000		V/μs	
V <sub>TM</sub>	I <sub>TM</sub> = 80 A	tp = 380 μs	T <sub>j</sub> = 25°C	MAX.	1.7	-	-	V
	I <sub>TM</sub> = 110 A	tp = 380 μs			-	1.75	-	
	I <sub>TM</sub> = 170 A	tp = 380 μs			-	-	1.75	
V <sub>t0</sub>	Threshold voltage		T <sub>j</sub> = 125°C	MAX.	0.85		V	
R <sub>d</sub>	Dynamic resistance		T <sub>j</sub> = 125°C	MAX.	11	7.0	5.5	mΩ
I <sub>DRM</sub> I <sub>R</sub>	V <sub>DRM</sub> / V <sub>R</sub> RATED		T <sub>j</sub> = 25°C	MAX.	20			μA
			T <sub>j</sub> = 125°C		10			mA

#### DIODE

Symbol	Test Conditions			MDS			Unit	
				35	50	80		
V <sub>F</sub>	I <sub>F</sub> = 80 A		T <sub>j</sub> = 25°C	MAX.	1.7	-	-	V
	I <sub>F</sub> = 110 A				-	1.7	-	
	I <sub>F</sub> = 170 A				-	-	1.7	
V <sub>t0</sub>	Threshold voltage		T <sub>j</sub> = 125°C	MAX.	0.85			V
R <sub>d</sub>	Dynamic resistance		T <sub>j</sub> = 125°C	MAX.	11	7.0	5.5	mΩ
I <sub>R</sub>	V <sub>R</sub> = V <sub>R</sub> RATED		T <sub>j</sub> = 25°C	MAX.	20			μA
			T <sub>j</sub> = 125°C		10			mA

**THERMAL RESISTANCES**

Symbol	Parameter	Value	Unit
R <sub>th(j-c)</sub>	Junction to case (DC)	MDS35	1.00
		MDS50	0.75
		MDS80	0.45

**PRODUCT SELECTOR**

Part Number	Voltage (xxx)		Sensitivity	Package
	800 V	1200 V		
MDS35-xxx	X	X	50 mA	ISOTOP™
MDS50-xxx	X	X	50 mA	
MDS80-xxx	X	X	150 mA	

**ORDERING INFORMATION**

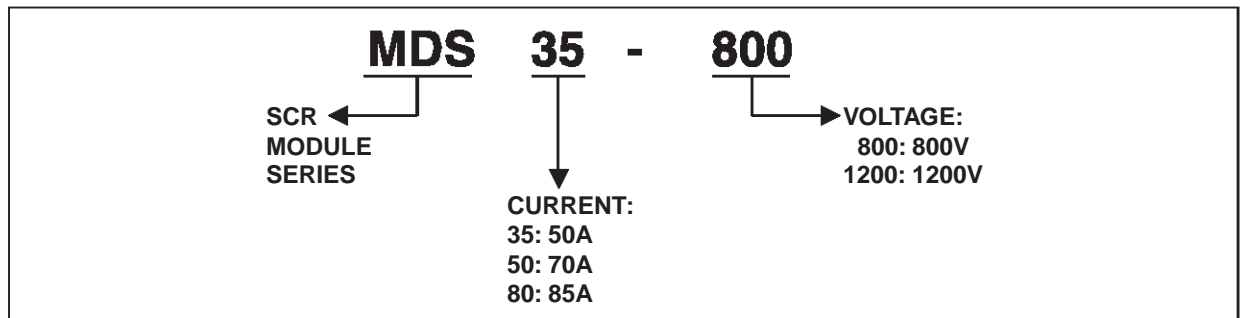

**OTHER INFORMATION**

Part Number	Marking	Weight	Base Quantity	Packing mode
MDS35-xxx	MDS35-xxx	27.0 g	10	Tube
MDS50-xxx	MDS50-xxx	27.0 g	10	Tube
MDS80-xxx	MDS80-xxx	27.0 g	10	Tube

**Note:** xxx = voltage

**Fig. 1-1:** Maximum average power dissipation versus average on-state current (thyristor or diode, sinusoidal waveform).

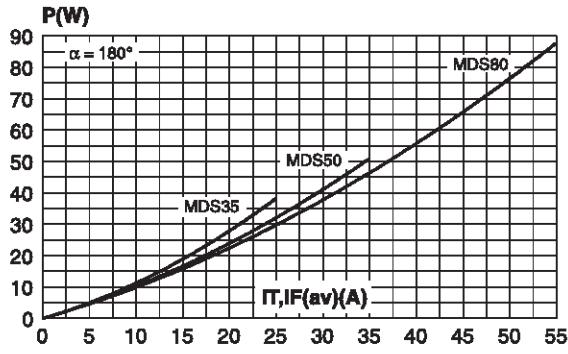

**Fig. 1-2:** Maximum average power dissipation versus average on-state current (thyristor or diode, rectangular waveform).

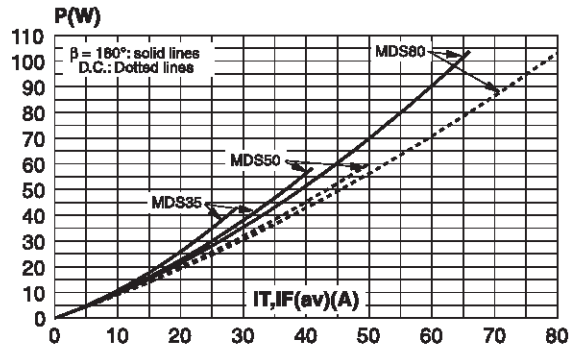

**Fig. 1-3:** Maximum total power dissipation versus output current on resistive or inductive load (Single phase bridge rectifier, two packages).

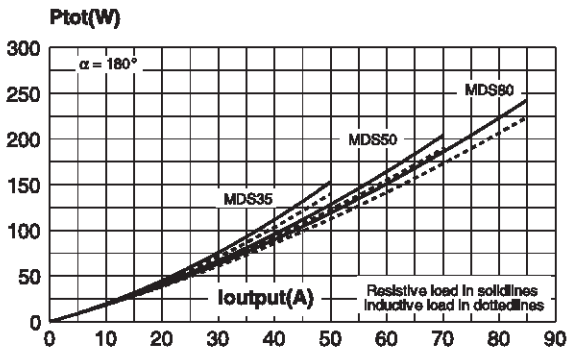

**Fig. 1-4:** Maximum total power dissipation versus output current (Three phase bridge rectifier, three packages).

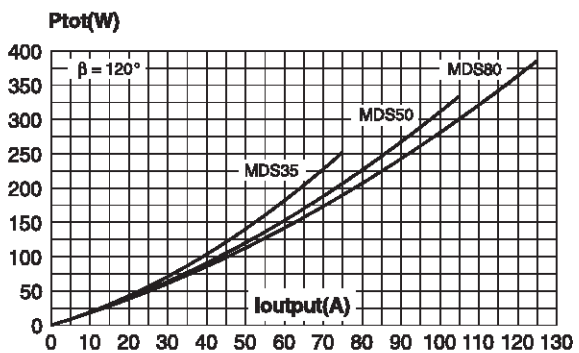

**Fig. 2-1:** Average on-state current versus case temperature (thyristor or diode, sinusoidal waveform).

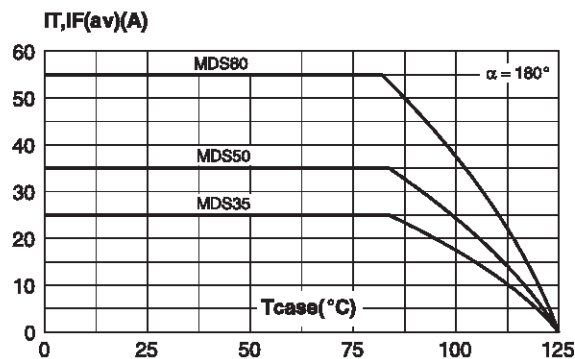

**Fig. 2-2:** Average on-state current versus case temperature (thyristor or diode, rectangular waveform).

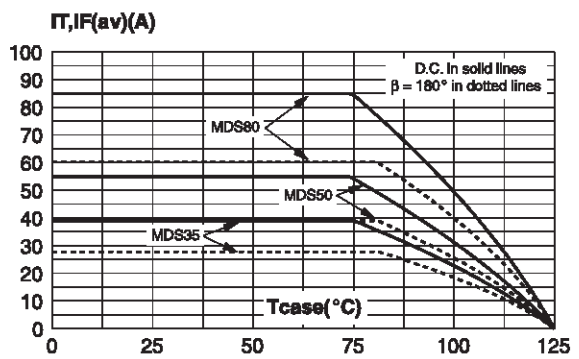

**Fig. 3:** Relative variation of thermal impedance junction to case versus pulse duration.

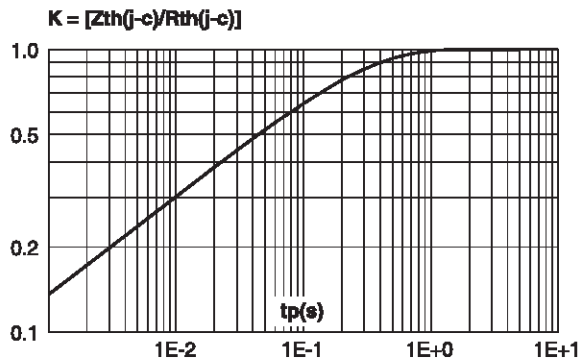

**Fig. 5-1:** Surge peak on-state current versus number of cycles (MDS35 and MDS50).

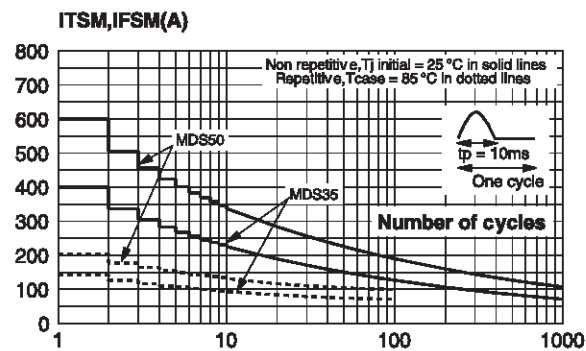

**Fig. 6-1:** Non-repetitive surge peak on-state current for a sinusoidal pulse with width  $t_p < 10$  ms, and corresponding value of  $I t$  (MDS35 and MDS50).

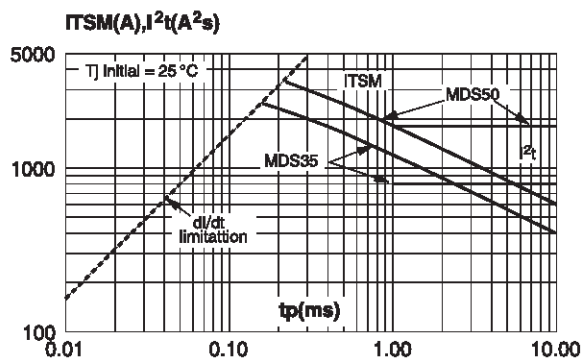

**Fig. 4:** Relative variation of gate trigger current, holding current and latching current versus junction temperature (typical values).

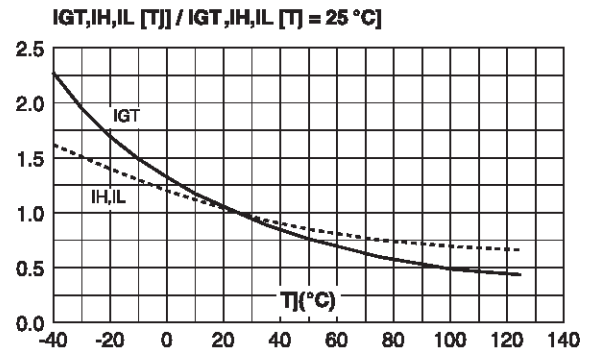

**Fig. 5-2:** Surge peak on-state current versus number of cycles (MDS80).

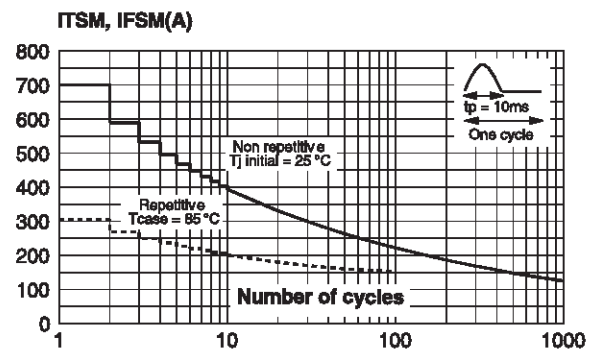

**Fig. 6-2:** Non repetitive surge peak on-state current for a sinusoidal pulse with width  $t_p < 10$  ms, and corresponding value of  $I t$  (MDS80).

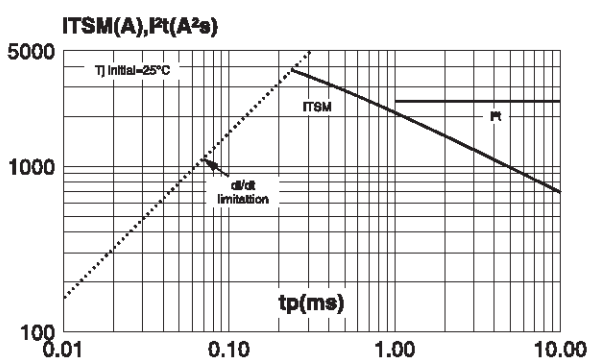

Fig. 7-1: On-state characteristics (thyristor or diode, maximum values) (MDS35).

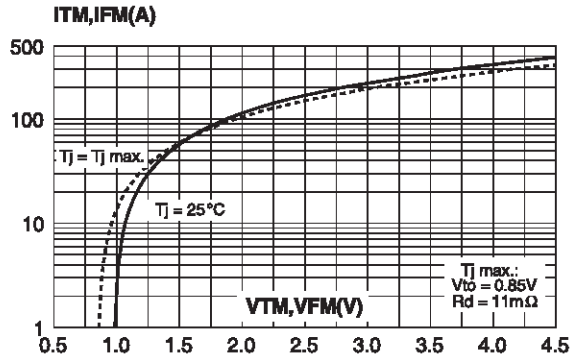

Fig. 7-2: On-state characteristics (thyristor or diode, maximum values) (MDS50).

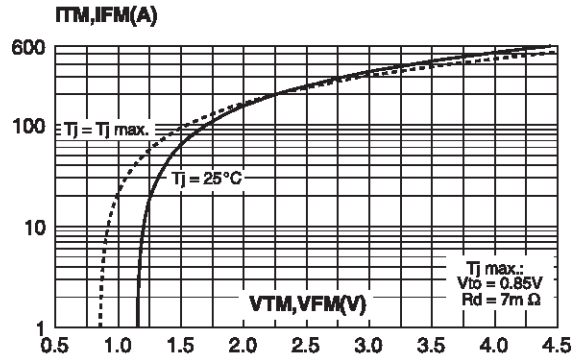
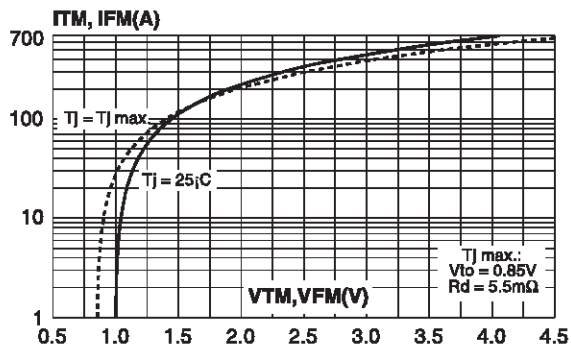
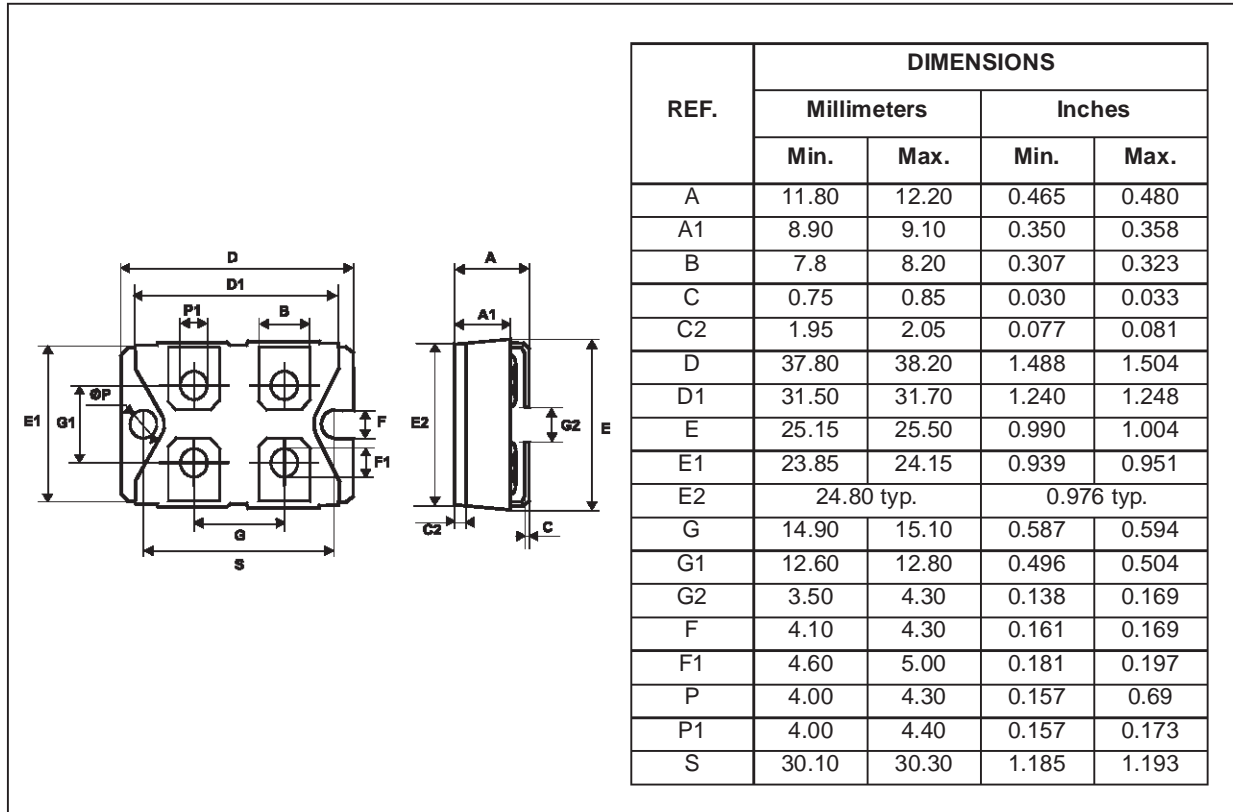

Fig. 7-3: On-state characteristics (thyristor or diode, maximum values) (MDS80).



## PACKAGE MECHANICAL DATA

ISOTOP™



- Recommended torque value: 1.3 Nm (max. 1.5 Nm) for the 6 x M4 screws (2 x M4 screws recommended for mounting the package on the heatsink and the 4 provided screws).
- The screws supplied with the package are adapted for mounting on a board (or other types of terminals) with a thickness of 0.6 mm min. and 2.2 mm max.

Information furnished is believed to be accurate and reliable. However, STMicroelectronics assumes no responsibility for the consequences of use of such information nor for any infringement of patents or other rights of third parties which may result from its use. No license is granted by implication or otherwise under any patent or patent rights of STMicroelectronics. Specifications mentioned in this publication are subject to change without notice. This publication supersedes and replaces all information previously supplied. STMicroelectronics products are not authorized for use as critical components in life support devices or systems without express written approval of STMicroelectronics.

© The ST logo is a registered trademark of STMicroelectronics

© 2000 STMicroelectronics - Printed in Italy - All Rights Reserved

STMicroelectronics GROUP OF COMPANIES

Australia - Brazil - China - Finland - France - Germany - Hong Kong - India - Italy - Japan - Malaysia - Malta - Morocco  
Singapore - Spain - Sweden - Switzerland - United Kingdom

<http://www.st.com>

