

# SAW Bandpass Filter F2204



## Features

- RF bandpass filter
- High attenuation
- No matching 50Ω single-ended operation
- Ceramic Surface Mounted Device (SMD) Package ( 5.0 mm \* 5.0 mm )
- RoHS Compliant

## Package Dimension – SMD 5.0 × 5.0

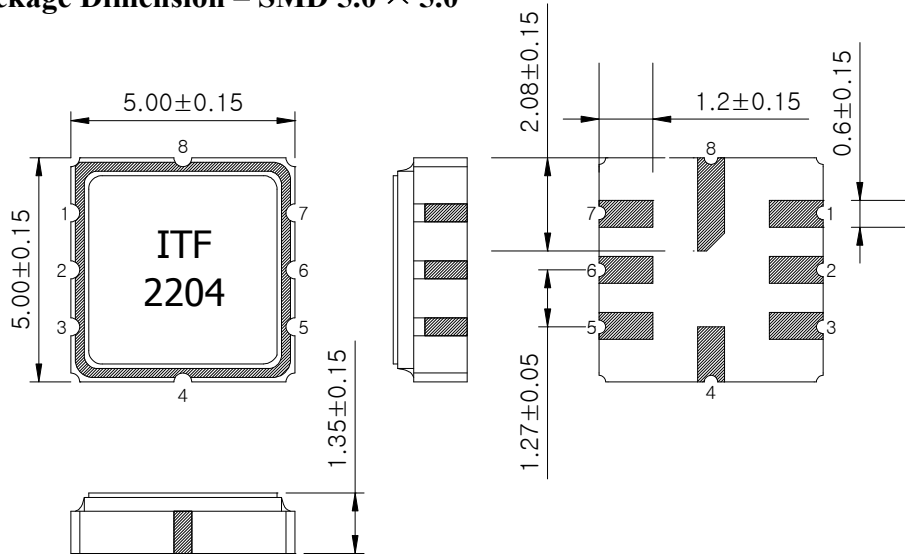

Dimensions shown are nominal in millimeters

Body :  $\text{Al}_2\text{O}_3$  Ceramic

Lid : Kovar, Ni Plated

Terminations : Au plating 0.3 ~ 1.0  $\mu\text{m}$ , Over a 1.27 ~ 8.89  $\mu\text{m}$  Ni Plating

Pin Configuration	
2	Input
6	Output
1, 3, 4, 5, 7, 8	Case ground

## Maximum Ratings

Parameter	Unit	Minimum	Typical	Maximum
Operating Temperature Range	°C	-40	25	85
Storage Temperature Range	°C	-40	25	85
Power Handling Capability	dBm	-	0	-

Electrostatics Sensitive Device (ESD)

	<b>ITF Co., Ltd.</b> 102-901, Bucheon Technopark 364, Samjeong-Dong, Ojeong-Gu, Bucheon-City, Gyeonggi-Do, Korea 421-809	Part No.	NSME01-F2204	
		Rev. Date	2011-05-04	
		Rev.	AS 01	1/7

# SAW Bandpass Filter F2204



## Specifications

Fc = 220 MHz

Terminating source impedance : 50Ω

Terminating load impedance : 50Ω

	Minimum	Typical	Maximum	Unit
Center Frequency ( Fc )	-	220	-	MHz
Insertion Loss (In Fc +/- 1.5 MHz)	-	3.5	4.0	dB
Amplitude Ripple (In Fc +/- 1.5 MHz)	-	1.2	2.0	dBp-p
VSWR (In Fc +/- 1.5 MHz)	-	1.8	2.5	
Relative Attenuation 120.0 ~ 177.5 MHz 259.5 ~ 320.0 MHz	50 50	55 55	- -	dB
Temperature Range (Operational)	-40	25	85	°C
Input/Output Impedance		50		Ohms

### Notes :

- 1) All specifications are based on the matching schematic shown below, measured by Agilent Network analyzer and full 2 port calibration.
- 2) Electrical margin has been built into the design to account for the variations due to temperature drift and manufacturing tolerances

 Integrated Technology Future	<b>ITF Co., Ltd.</b> 102-901, Bucheon Technopark 364, Samjeong-Dong, Ojeong-Gu, Bucheon-City, Gyeonggi-Do, Korea 421-809	Part No.	NSME01-F2204	
		Rev. Date	2011-05-04	
		Rev.	AS 01	2/7

# SAW Bandpass Filter F2204



## Matching Schematic

( Actual matching values may vary due to PCB layout and parasitics )



## Marking Configuration

ITF <sup>1)</sup>

2204 <sup>2)</sup>

1) Manufacturer name

2) Marking Number

\* Ink or Laser Marking available

 Integrated Technology Future	<b>ITF Co., Ltd.</b> 102-901, Bucheon Technopark 364, Samjeong-Dong, Ojeong-Gu, Bucheon-City, Gyeonggi-Do, Korea 421-809	Part No.	NSME01-F2204	
		Rev. Date	2011-05-04	
		Rev.	AS 01	3/7

# SAW Bandpass Filter F2204



## Typical Performance ( at 25 °C )

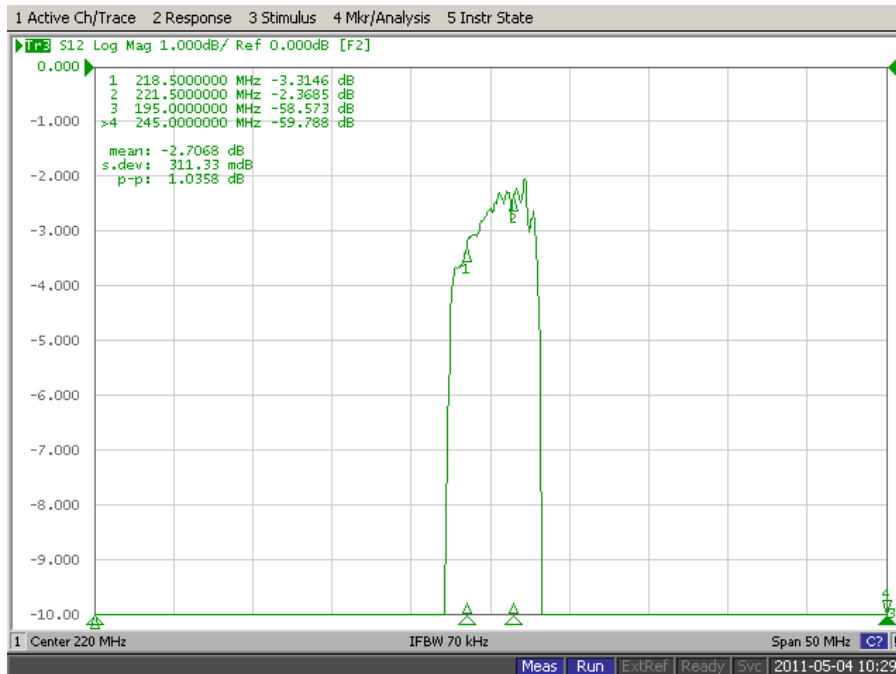
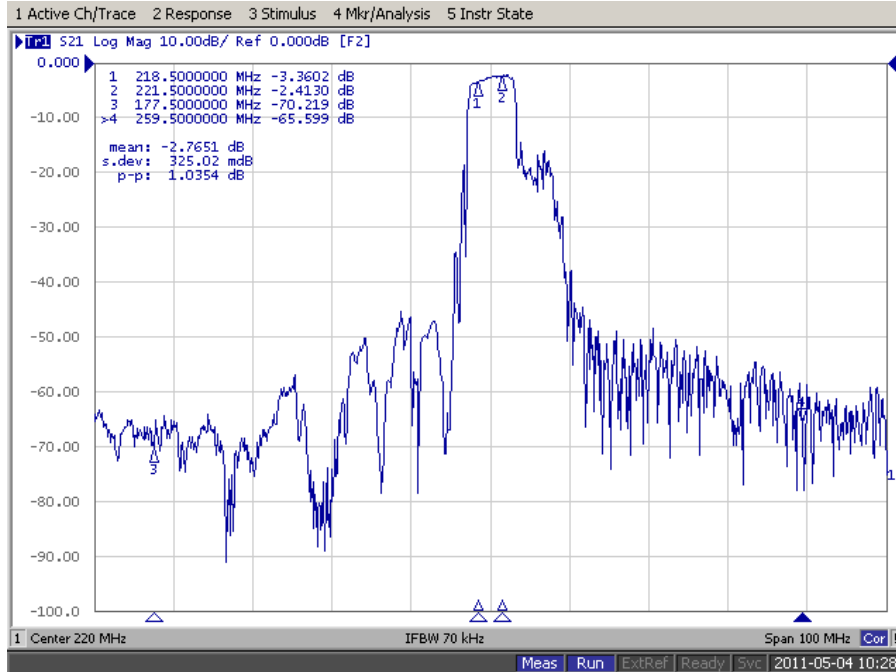

	<b>ITF Co., Ltd.</b> 102-901, Bucheon Technopark 364, Samjeong-Dong, Ojeong-Gu, Bucheon-City, Gyeonggi-Do, Korea 421-809	Part No.	NSME01-F2204	
		Rev. Date	2011-05-04	
		Rev.	AS 01	4/7

# SAW Bandpass Filter F2204



## Input / Output VSWR Charts

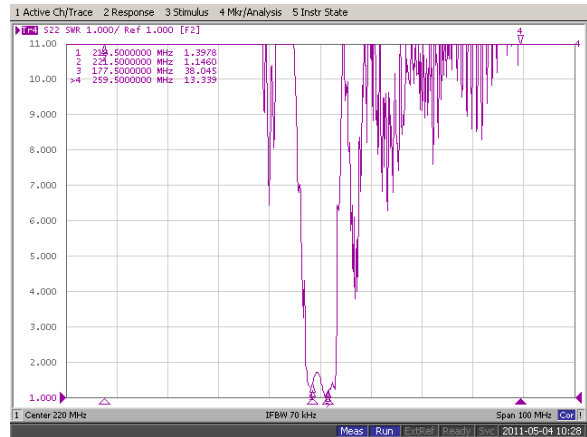
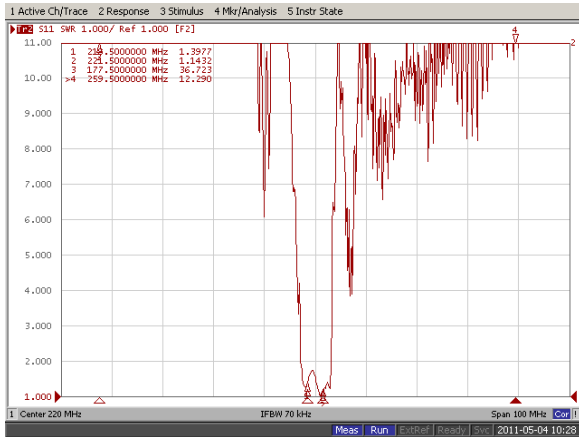

## Input / Output Smith Charts

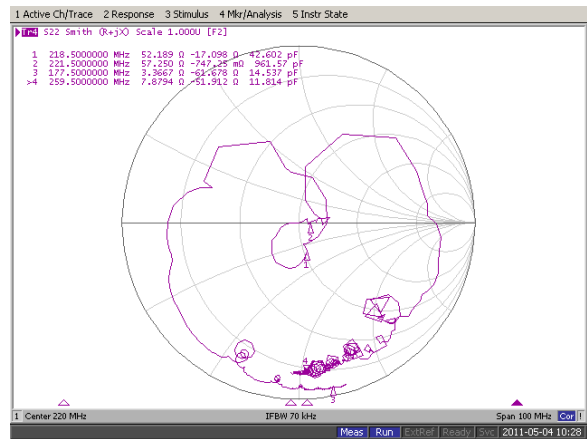
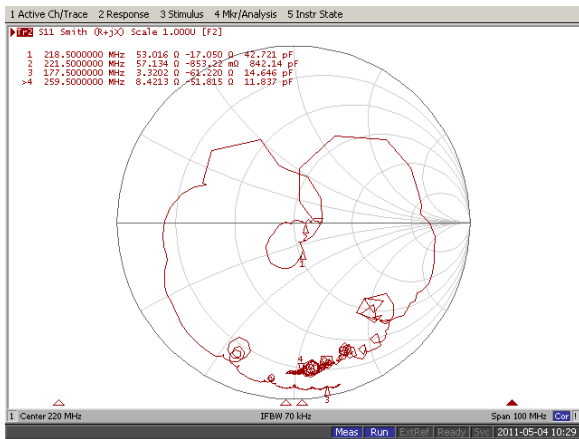

**ITF Co., Ltd.**  
 102-901, Bucheon Technopark 364,  
 Samjeong-Dong, Ojeong-Gu, Bucheon-City,  
 Gyeonggi-Do, Korea 421-809

Part No.	NSME01-F2204	
Rev. Date	2011-05-04	
Rev.	AS 01	5/7

# SAW Bandpass Filter F2204



## Packing Specification

1. Reeling Quantity : 1000 pcs / reel
2. Taping Structure : The tape shall be wound around the reel in the direction shown below.

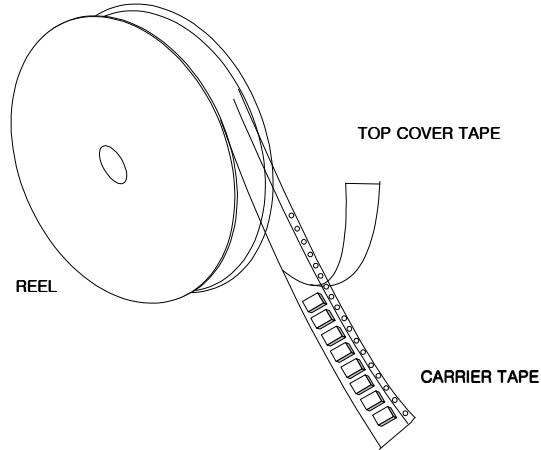

## Tape Specification

1. Leader part and vacant position specification

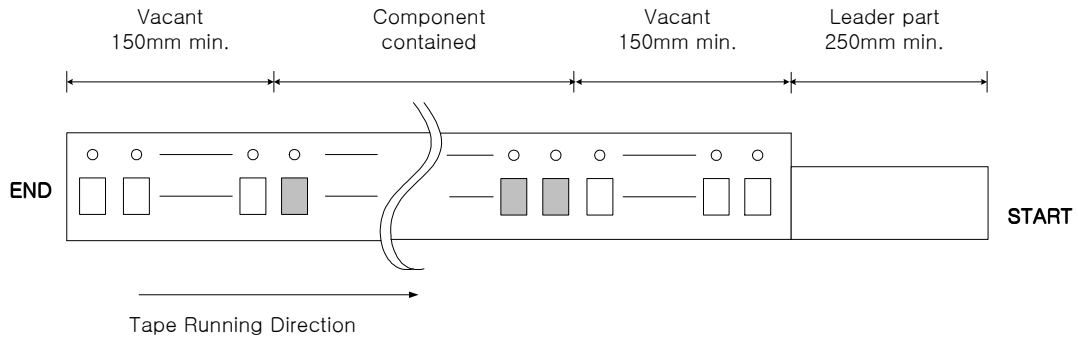

2. Tensile strength of carrier tape

4.4N/mm width

3. Top cover tape adhesion

- 1) pull off angle : 0~15°
- 2) speed : 300mm/min
- 3) force : 20~70g

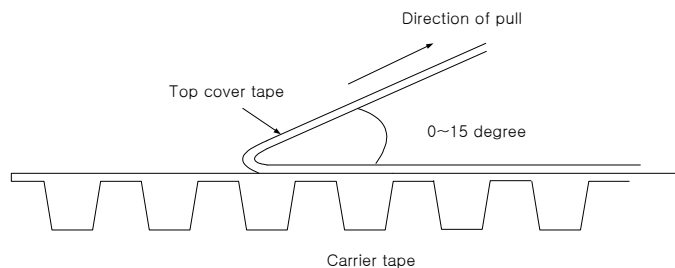

	<b>ITF Co., Ltd.</b> 102-901, Bucheon Technopark 364, Samjeong-Dong, Ojeong-Gu, Bucheon-City, Gyeonggi-Do, Korea 421-809	Part No.	NSME01-F2204	
		Rev. Date	2011-05-04	
		Rev.	AS 01	6/7

