



Ferrites and accessories

EELP 32, EILP 32
Core set (with and without clamp recess)

Series/Type: B66287G, B65808, B66287K, B66288, B66457G, B66457K

Date: June 2013

ELP 32/6/20
Core and accessories (with clamp recess)
B66287, B65808
Core set EELP 32
Combination: ELP 32/6/20 with ELP 32/6/20

- To IEC 62317-9
- Delivery mode: single units

Magnetic characteristics (per set)

$$\Sigma l/A = 0.32 \text{ mm}^{-1}$$

$$l_e = 41.4 \text{ mm}$$

$$A_e = 130 \text{ mm}^2$$

$$A_{\min} = 128 \text{ mm}^2$$

$$V_e = 5390 \text{ mm}^3$$

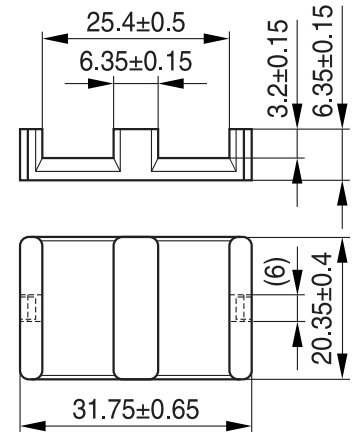
Approx. weight 28 g/set
ELP 32/6/20

FEK0520-S

Ungapped

Material	A_L value nH	μ_e	B_S^* mT	P_V W/set	Ordering code (per piece)
N49	3900 ±25%	990	250	< 1.40 (50 mT, 500 kHz, 100 °C)	B66287G0000X149
N92	4300 ±25%	1090	350	< 3.70 (200 mT, 100 kHz, 100 °C)	B66287G0000X192
N87	5700 ±25%	1450	300	< 3.40 (200 mT, 100 kHz, 100 °C)	B66287G0000X187
N97	5700 ±25%	1440	310	< 2.60 (200 mT, 100 kHz, 100 °C)	B66287G0000X197
N95	6900 ±25%	1740	310	< 3.40 (200 mT, 100 kHz, 25 °C) < 3.10 (200 mT, 100 kHz, 100 °C)	B66287G0000X195

 * $H = 250 \text{ A/m}$; $f = 10 \text{ kHz}$; $T = 100 \text{ °C}$
Calculation factors (for formulas, see "E cores: general information")
EELP 32:

Material	Relationship between air gap – A_L value		Calculation of saturation current			
	K1 (25 °C)	K2 (25 °C)	K3 (25 °C)	K4 (25 °C)	K3 (100 °C)	K4 (100 °C)
N87	208	-0.819	367	-0.796	322	-0.873

 Validity range: K1, K2: $0.10 \text{ mm} < s < 1.50 \text{ mm}$
 K3, K4: $150 \text{ nH} < A_L < 1000 \text{ nH}$
Clamp

Ordering code per piece, 2 pieces required

Ordering code: B65808J2204X000

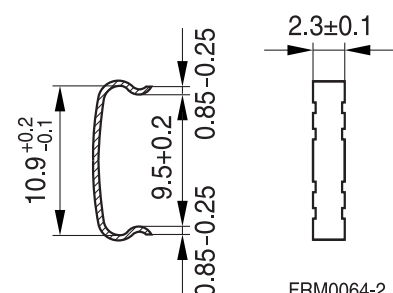

FRM0064-2

ELP 32/6/20 with I 32/3/20
Core and accessories (with clamp recess)
B66287
Core set EILP 32
Combination:
ELP 32/6/20 with I 32/3/20

- To IEC 62317-9
- Delivery mode: single units

Magnetic characteristics (per set)

$$\Sigma l/A = 0.27 \text{ mm}^{-1}$$

$$l_e = 35.1 \text{ mm}$$

$$A_e = 130 \text{ mm}^2$$

$$A_{\min} = 128 \text{ mm}^2$$

$$V_e = 4560 \text{ mm}^3$$

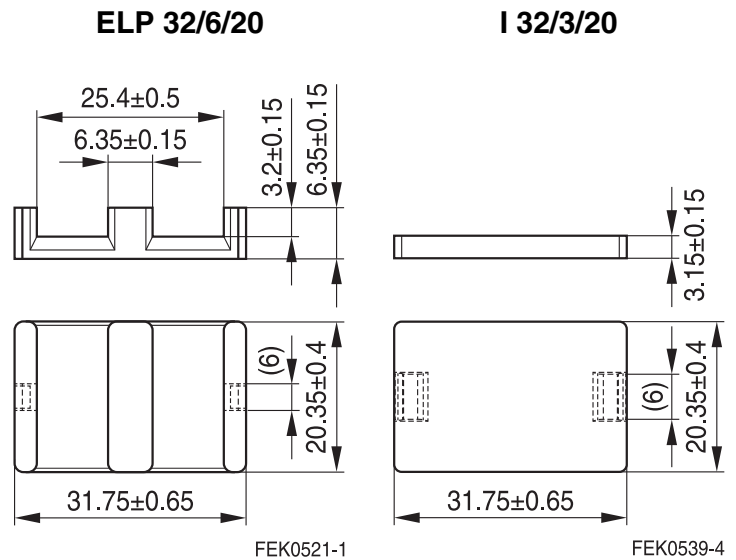
Approx. weight 24 g/set

Ungapped

Material	A_L value nH	μ_e	B_S^* mT	P_V W/set	Ordering code (per piece)
N49	4400 $\pm 25\%$	950	250	< 1.20 (50 mT, 500 kHz, 100 °C)	B66287G0000X149 (ELP core) B66287K0000X149 (I core)**
N92	4800 $\pm 25\%$	1031	350	< 3.20 (200 mT, 100 kHz, 100 °C)	B66287G0000X192 (ELP core) B66287K0000X192 (I core)**
N87	6300 $\pm 25\%$	1350	300	< 2.90 (200 mT, 100 kHz, 100 °C)	B66287G0000X187 (ELP core) B66287K0000X187 (I core)**
N97	6300 $\pm 25\%$	1350	310	< 2.20 (200 mT, 100 kHz, 100 °C)	B66287G0000X197 (ELP core) B66287K0000X197 (I core)**
N95	7550 $\pm 25\%$	1618	310	< 2.90 (200 mT, 100 kHz, 25 °C) < 2.60 (200 mT, 100 kHz, 100 °C)	B66287G0000X195 (ELP core) B66287K0000X195 (I core)**

* $H = 250 \text{ A/m}$; $f = 10 \text{ kHz}$; $T = 100 \text{ °C}$

** Plate-type tool type

Calculation factors (for formulas, see “E cores: general information”)

EILP 32:

Material	Relationship between air gap – A_L value		Calculation of saturation current			
	K1 (25 °C)	K2 (25 °C)	K3 (25 °C)	K4 (25 °C)	K3 (100 °C)	K4 (100 °C)
N87	234	-0.777	379	-0.796	329	-0.873

Validity range: K1, K2: $0.10 \text{ mm} < s < 1.50 \text{ mm}$
 K3, K4: $150 \text{ nH} < A_L < 1000 \text{ nH}$

Clamp

Ordering code per piece, 2 pieces required

Ordering code: B66288F2204X000

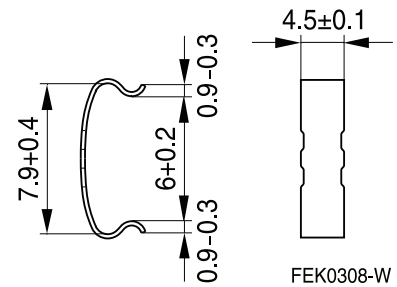

Core set EELP 32
Combination: ELP 32/6/20 with ELP 32/6/20

- To IEC 62317-9
- Delivery mode: single units

Magnetic characteristics (per set)

$$\Sigma l/A = 0.32 \text{ mm}^{-1}$$

$$l_e = 41.4 \text{ mm}$$

$$A_e = 130 \text{ mm}^2$$

$$A_{\min} = 128 \text{ mm}^2$$

$$V_e = 5390 \text{ mm}^3$$

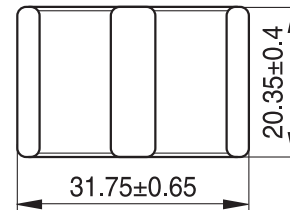
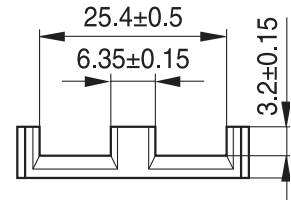
Approx. weight 28 g/set
ELP 32/6/20

Ungapped

Material	A_L value nH	μ_e	B_S^* mT	P_V W/set	Ordering code (per piece)
N49	3900 ±25%	990	250	< 1.40 (50 mT, 500 kHz, 100 °C)	B66457G0000X149
N92	4300 ±25%	1090	350	< 3.70 (200 mT, 100 kHz, 100 °C)	B66457G0000X192
N87	5700 ±25%	1450	300	< 3.40 (200 mT, 100 kHz, 100 °C)	B66457G0000X187
N97	5700 ±25%	1440	310	< 2.60 (200 mT, 100 kHz, 100 °C)	B66457G0000X197

* $H = 250 \text{ A/m}$; $f = 10 \text{ kHz}$; $T = 100 \text{ °C}$

Calculation factors (for formulas, see "E cores: general information")
EELP 32:

Material	Relationship between air gap – A_L value		Calculation of saturation current			
	K1 (25 °C)	K2 (25 °C)	K3 (25 °C)	K4 (25 °C)	K3 (100 °C)	K4 (100 °C)
N87	208	-0.819	367	-0.796	322	-0.873

Validity range: K1, K2: $0.10 \text{ mm} < s < 1.50 \text{ mm}$
 K3, K4: $150 \text{ nH} < A_L < 1000 \text{ nH}$

ELP 32/6/20 with I 32/3/20
Core (without clamp recess)
B66457
Core set EILP 32
Combination:
ELP 32/6/20 with I 32/3/20

- To IEC 62317-9
- Delivery mode: single units

Magnetic characteristics (per set)

$$\Sigma l/A = 0.27 \text{ mm}^{-1}$$

$$l_e = 35.1 \text{ mm}$$

$$A_e = 130 \text{ mm}^2$$

$$A_{\min} = 128 \text{ mm}^2$$

$$V_e = 4560 \text{ mm}^3$$

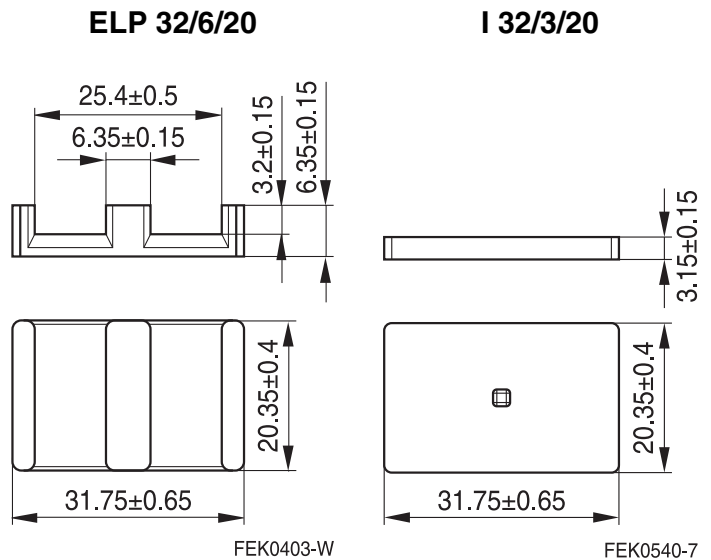
Approx. weight 24 g/set

Ungapped

Material	A_L value nH	μ_e	B_S^* mT	P_V W/set	Ordering code (per piece)
N49	4400 ±25%	950	250	< 1.20 (50 mT, 500 kHz, 100 °C)	B66457G0000X149 (ELP core) B66457K0000X149 (I core)**
N92	4800 ±25%	1031	350	< 3.20 (200 mT, 100 kHz, 100 °C)	B66457G0000X192 (ELP core) B66457K0000X192 (I core)**
N87	6300 ±25%	1350	300	< 2.90 (200 mT, 100 kHz, 100 °C)	B66457G0000X187 (ELP core) B66457K0000X187 (I core)**
N97	6300 ±25%	1350	310	< 2.20 (200 mT, 100 kHz, 100 °C)	B66457G0000X197 (ELP core) B66457K0000X197 (I core)**

* $H = 250 \text{ A/m}$; $f = 10 \text{ kHz}$; $T = 100 \text{ °C}$

** Plate-type tool type

Calculation factors (for formulas, see "E cores: general information")
EILP 32:

Material	Relationship between air gap – A_L value		Calculation of saturation current			
	K1 (25 °C)	K2 (25 °C)	K3 (25 °C)	K4 (25 °C)	K3 (100 °C)	K4 (100 °C)
N87	234	-0.777	379	-0.796	329	-0.873

Validity range: K1, K2: $0.10 \text{ mm} < s < 1.50 \text{ mm}$
K3, K4: $150 \text{ nH} < A_L < 1000 \text{ nH}$

Mechanical stress and mounting

Ferrite cores have to meet mechanical requirements during assembling and for a growing number of applications. Since ferrites are ceramic materials one has to be aware of the special behavior under mechanical load.

As valid for any ceramic material, ferrite cores are brittle and sensitive to any shock, fast changing or tensile load. Especially high cooling rates under ultrasonic cleaning and high static or cyclic loads can cause cracks or failure of the ferrite cores.

For detailed information see chapter *“Definitions”*, section 8.1.

Effects of core combination on A_L value

Stresses in the core affect not only the mechanical but also the magnetic properties. It is apparent that the initial permeability is dependent on the stress state of the core. The higher the stresses are in the core, the lower is the value for the initial permeability. Thus the embedding medium should have the greatest possible elasticity.

For detailed information see chapter *“Definitions”*, section 8.2.

Heating up

Ferrites can run hot during operation at higher flux densities and higher frequencies.

NiZn-materials

The magnetic properties of NiZn-materials can change irreversible in high magnetic fields.

Processing notes

- The start of the winding process should be soft. Else the flanges may be destroyed.
- To strong winding forces may blast the flanges or squeeze the tube that the cores can no more be mounted.
- To long soldering time at high temperature (>300 °C) may effect coplanarity or pin arrangement.
- Not following the processing notes for soldering of the J-leg terminals may cause solderability problems at the transformer because of pollution with Sn oxyd of the tin bath or burned insulation of the wire. For detailed information see chapter *“Processing notes”*, section 8.2.
- The dimensions of the hole arrangement have fixed values and should be understood as a recommendation for drilling the printed circuit board. For dimensioning the pins, the group of holes can only be seen under certain conditions, as they fit into the given hole arrangement. To avoid problems when mounting the transformer, the manufacturing tolerances for positioning the customers' drilling process must be considered by increasing the hole diameter.

Ferrites and accessories
Symbols and terms

Symbol	Meaning	Unit
A	Cross section of coil	mm ²
A _e	Effective magnetic cross section	mm ²
A _L	Inductance factor; $A_L = L/N^2$	nH
A _{L1}	Minimum inductance at defined high saturation ($\cong \mu_a$)	nH
A _{min}	Minimum core cross section	mm ²
A _N	Winding cross section	mm ²
A _R	Resistance factor; $A_R = R_{Cu}/N^2$	$\mu\Omega = 10^{-6} \Omega$
B	RMS value of magnetic flux density	Vs/m ² , mT
ΔB	Flux density deviation	Vs/m ² , mT
\hat{B}	Peak value of magnetic flux density	Vs/m ² , mT
$\Delta \hat{B}$	Peak value of flux density deviation	Vs/m ² , mT
B _{DC}	DC magnetic flux density	Vs/m ² , mT
B _R	Remanent flux density	Vs/m ² , mT
B _S	Saturation magnetization	Vs/m ² , mT
C ₀	Winding capacitance	F = As/V
CDF	Core distortion factor	mm ^{-4.5}
DF	Relative disaccommodation coefficient $DF = d/\mu_i$	
d	Disaccommodation coefficient	
E _a	Activation energy	J
f	Frequency	s ⁻¹ , Hz
f _{cutoff}	Cut-off frequency	s ⁻¹ , Hz
f _{max}	Upper frequency limit	s ⁻¹ , Hz
f _{min}	Lower frequency limit	s ⁻¹ , Hz
f _r	Resonance frequency	s ⁻¹ , Hz
f _{Cu}	Copper filling factor	
g	Air gap	mm
H	RMS value of magnetic field strength	A/m
\hat{H}	Peak value of magnetic field strength	A/m
H _{DC}	DC field strength	A/m
H _c	Coercive field strength	A/m
h	Hysteresis coefficient of material	10 ⁻⁶ cm/A
h/ μ_i^2	Relative hysteresis coefficient	10 ⁻⁶ cm/A
I	RMS value of current	A
I _{DC}	Direct current	A
\hat{I}	Peak value of current	A
J	Polarization	Vs/m ²
k	Boltzmann constant	J/K
k ₃	Third harmonic distortion	
k _{3c}	Circuit third harmonic distortion	
L	Inductance	H = Vs/A

Ferrites and accessories
Symbols and terms

Symbol	Meaning	Unit
$\Delta L/L$	Relative inductance change	H
L_0	Inductance of coil without core	H
L_H	Main inductance	H
L_p	Parallel inductance	H
L_{rev}	Reversible inductance	H
L_s	Series inductance	H
l_e	Effective magnetic path length	mm
l_N	Average length of turn	mm
N	Number of turns	
P_{Cu}	Copper (winding) losses	W
P_{trans}	Transferrable power	W
P_V	Relative core losses	mW/g
PF	Performance factor	
Q	Quality factor ($Q = \omega L/R_s = 1/\tan \delta_L$)	
R	Resistance	Ω
R_{Cu}	Copper (winding) resistance ($f = 0$)	Ω
R_h	Hysteresis loss resistance of a core	Ω
ΔR_h	R_h change	Ω
R_i	Internal resistance	Ω
R_p	Parallel loss resistance of a core	Ω
R_s	Series loss resistance of a core	Ω
R_{th}	Thermal resistance	K/W
R_V	Effective loss resistance of a core	Ω
s	Total air gap	mm
T	Temperature	$^{\circ}\text{C}$
ΔT	Temperature difference	K
T_C	Curie temperature	$^{\circ}\text{C}$
t	Time	s
t_v	Pulse duty factor	
$\tan \delta$	Loss factor	
$\tan \delta_L$	Loss factor of coil	
$\tan \delta_r$	(Residual) loss factor at $H \rightarrow 0$	
$\tan \delta_e$	Relative loss factor	
$\tan \delta_h$	Hysteresis loss factor	
$\tan \delta/\mu_i$	Relative loss factor of material at $H \rightarrow 0$	
U	RMS value of voltage	V
\hat{U}	Peak value of voltage	V
V_e	Effective magnetic volume	mm^3
Z	Complex impedance	Ω
Z_n	Normalized impedance $ Z _n = Z /N^2 \times \epsilon (l_e/A_e)$	Ω/mm

Ferrites and accessories

Symbols and terms

Symbol	Meaning	Unit
α	Temperature coefficient (TK)	1/K
α_F	Relative temperature coefficient of material	1/K
α_e	Temperature coefficient of effective permeability	1/K
ε_r	Relative permittivity	
Φ	Magnetic flux	Vs
η	Efficiency of a transformer	
η_B	Hysteresis material constant	mT ⁻¹
η_i	Hysteresis core constant	A ⁻¹ H ^{-1/2}
λ_s	Magnetostriction at saturation magnetization	
μ	Relative complex permeability	
μ_0	Magnetic field constant	Vs/Am
μ_a	Relative amplitude permeability	
μ_{app}	Relative apparent permeability	
μ_e	Relative effective permeability	
μ_i	Relative initial permeability	
μ_p'	Relative real (inductive) component of $\bar{\mu}$ (for parallel components)	
μ_p''	Relative imaginary (loss) component of $\bar{\mu}$ (for parallel components)	
μ_r	Relative permeability	
μ_{rev}	Relative reversible permeability	
μ_s'	Relative real (inductive) component of $\bar{\mu}$ (for series components)	
μ_s''	Relative imaginary (loss) component of $\bar{\mu}$ (for series components)	
μ_{tot}	Relative total permeability derived from the static magnetization curve	
ρ	Resistivity	Ωm^{-1}
$\Sigma l/A$	Magnetic form factor	mm ⁻¹
τ_{Cu}	DC time constant $\tau_{Cu} = L/R_{Cu} = A_L/A_R$	s
ω	Angular frequency; $\omega = 2 \pi f$	s ⁻¹

All dimensions are given in mm.

SMD Surface-mount device

Important notes

The following applies to all products named in this publication:

1. Some parts of this publication contain **statements about the suitability of our products for certain areas of application**. These statements are based on our knowledge of typical requirements that are often placed on our products in the areas of application concerned. We nevertheless expressly point out **that such statements cannot be regarded as binding statements about the suitability of our products for a particular customer application**. As a rule, EPCOS is either unfamiliar with individual customer applications or less familiar with them than the customers themselves. For these reasons, it is always ultimately incumbent on the customer to check and decide whether an EPCOS product with the properties described in the product specification is suitable for use in a particular customer application.
2. We also point out that **in individual cases, a malfunction of electronic components or failure before the end of their usual service life cannot be completely ruled out in the current state of the art, even if they are operated as specified**. In customer applications requiring a very high level of operational safety and especially in customer applications in which the malfunction or failure of an electronic component could endanger human life or health (e.g. in accident prevention or lifesaving systems), it must therefore be ensured by means of suitable design of the customer application or other action taken by the customer (e.g. installation of protective circuitry or redundancy) that no injury or damage is sustained by third parties in the event of malfunction or failure of an electronic component.
3. **The warnings, cautions and product-specific notes must be observed.**
4. In order to satisfy certain technical requirements, **some of the products described in this publication may contain substances subject to restrictions in certain jurisdictions (e.g. because they are classed as hazardous)**. Useful information on this will be found in our Material Data Sheets on the Internet (www.epcos.com/material). Should you have any more detailed questions, please contact our sales offices.
5. We constantly strive to improve our products. Consequently, **the products described in this publication may change from time to time**. The same is true of the corresponding product specifications. Please check therefore to what extent product descriptions and specifications contained in this publication are still applicable before or when you place an order. We also **reserve the right to discontinue production and delivery of products**. Consequently, we cannot guarantee that all products named in this publication will always be available. The aforementioned does not apply in the case of individual agreements deviating from the foregoing for customer-specific products.
6. Unless otherwise agreed in individual contracts, **all orders are subject to the current version of the "General Terms of Delivery for Products and Services in the Electrical Industry" published by the German Electrical and Electronics Industry Association (ZVEI)**.
7. The trade names EPCOS, BAOKE, Alu-X, CeraDiode, CeraLink, CSMP, CSSP, CTVS, DeltaCap, DigiSiMic, DSSP, FilterCap, FormFit, MiniBlue, MiniCell, MKD, MKK, MLSC, MotorCap, PCC, PhaseCap, PhaseCube, PhaseMod, PhiCap, SIFERRIT, SIFI, SIKOREL, SilverCap, SIMDAD, SiMic, SIMID, SineFormer, SIOV, SIP5D, SIP5K, ThermoFuse, WindCap are **trademarks registered or pending** in Europe and in other countries. Further information will be found on the Internet at www.epcos.com/trademarks.