

# Power Distribution Blocks & Terminal Blocks with High Short-Circuit Current Ratings

## Table of Contents

	Page
Selection Table .....	2
<b>Power Distribution Blocks</b>	
PDBFS Series .....	3-8
PDB Series .....	9-12
<b>Terminal Blocks</b>	
16XXX-UL Series .....	13-15
14002-3-UL, TB300-03SP-UL, NDN63-WH-UL, NDN111-WH-UL .....	16-18
Application Notes .....	19-23

### TOOLS TO ASSIST

#### Panel Layout

2D and 3D CAD files for some products to facilitate panel layouts found at [www.cooperbussmann.com](http://www.cooperbussmann.com)

#### Engineering Services for SCCR

OSCAR™ Compliance Software Eliminates the Guesswork in Assembly Short-Circuit Current Rating (SCCR) Calculations. The Cooper Bussmann innovative OSCAR™ Compliance Software assists customer compliance with new Code and standards requirements for short-circuit current ratings as they relate to industrial control panels, equipment and assemblies. Go to [www.cooperbussmann.com](http://www.cooperbussmann.com)

SCCR Panel Design Review for Improving Your Assembly SCCR. If your SCCR needs improvement, contact the Cooper Bussmann team for a design review. We guarantee our panel SCCR review service for UL508A Supplement SB pre-certification.

#### Other Application Information on SCCR

Publications:

- Advanced Guide To Understanding Assembly Short-Circuit Current Rating
- Simplified Guide To Understanding Short-Circuit Current Rating – Find It, Fix It, Forget it
- SPD (Selecting Protective Devices) Sections on Industrial Control Panels and also Conductor & Terminations.

### Technical Assistance

#### Application Engineering

Application Engineering assistance is available to customers. The Application Engineering team is staffed by engineers and available by phone with technical and application support Monday – Friday, 8:00 a.m. – 5:00 p.m. Central Time.

Application Engineering can be reached via phone, fax or email:

- Phone: 636-527-1270
- Fax: 636-527-1607
- E-mail: [fusetech@cooperbussmann.com](mailto:fusetech@cooperbussmann.com)

#### Online Resources

Visit [www.cooperbussmann.com](http://www.cooperbussmann.com) for the following resources:

- Arc-flash calculator
- OSCAR™ compliance software
- Training modules

#### Services

- Engineering
- Training
- Testing

Contact us for more information on Services:

- Phone: 636-207-3294
- E-mail: [services@cooperbussmann.com](mailto:services@cooperbussmann.com)

# Selection Table for SCCR Power Distribution Blocks and Terminal Blocks

## Short-Circuit Current Rated Power Distribution Blocks

Cooper Bussmann offers three distinctly different styles of short-circuit current rated power distribution blocks (PDBs) and terminal blocks (TBs) to match different application needs. The differences are whether the power distribution blocks are enclosed or not, and whether they are UL1953 Listed PDBs or UL1059 Recognized TBs, which have different minimum spacing requirements. The table on this page can assist in the selection of the right series for your application requirements.

### Why these are important?

Assembly short-circuit current ratings (SCCRs) are now required in the 2005 NEC® and UL508A Listed Industrial

Control Panels. Marking the SCCR on Industrial Control Panels (NEC® 409.110), Industrial Machinery Electrical Panels (NEC® 670.3(A)), and HVAC equipment (NEC® 440.4(B)) is now required by the National Electrical Code. PDBs or TBs not marked with a SCCR are typically one of the weakest links and may limit an assembly to no more than 10kA SCCR. The PDBFS and PDB Series have increased spacing required where used in feeder circuits in equipment listed to UL508A (UL1059 TBs must be evaluated for proper spacings). Also, for building wiring systems, the PDBFS Series and PDB Series power distribution blocks can be used to meet the new 2005 NEC® requirements in section 376.56(B) for PDBs in wireways.

More application information on pages 19-23.

## Selection Table

Product	Catalog Page	UL	Enclosed	High SCCR*	Spacing** 1" Air 2" Surface	Industrial Control Panels UL 508A Branch Circuit	Industrial Control Panels UL 508A Feeder Circuit	HVAC UL 1995	Wireways NEC® 376.56(B) (Requires UL 1953)
Series PDBFS	3	UL 1953 Listed Power Distribution Blocks	Yes†	Yes	Yes	Yes	Yes	Yes	Yes
Series PDB	9	UL 1953 Listed Power Distribution Blocks	No***	Yes	Yes	Yes	Yes	Yes	Yes w/optional cover
Series 16XXX_UL	13	UL 1059 Recognized Terminal Blocks	No***	Yes	No****	Yes	No****	Yes	No
NDN63-WH-UL, NDN111-WH-UL, 14002-3-UL, TB300-03SP-UL	16	UL 1059 Recognized Terminal Blocks	No	Yes	No	Yes	No	Yes	No

† IP-20 finger-safe under specific conditions, see datasheet page 8.

\*When protected by proper fuse class with maximum ampere rating specified or smaller.

\*\* See **PDB Spacing Requirements for Equipment** table below.

\*\*\*Optional covers are available. Not IP-20, but provide a safety benefit.

\*\*\*\*No, except: Yes, if single pole units installed with proper spacings.

## PDB & TB Minimum Spacing Requirements for Equipment

UL Standard	Spacing between live parts of opposite polarity		Spacing between live parts and grounded parts or enclosure @600V
	Through air @600V	Over surface @600V	
508A Feeder Circuits	1"	2"	1"
508A Branch Circuits	3/8"	1/2"	1/2"
1995 HVAC	3/8"	1/2"	1/2"

Note: Refer to Specific UL standards for complete spacing details.



Series PDBFS



Series PDB



Magnum Terminal Blocks



Series 162 and 163

# Series PDBFS Enclosed Power Distribution Blocks

## Feature/Benefits

- Enclosed for enhanced safety; IP-20 finger-safe under specific conditions, see page 8
- High Short-Circuit Current Ratings up to 200,000A: PDBs do not have to be a weak link in achieving a high SCCR for an industrial control panel
- Suitable for installation in wireways and industrial control panel feeder and branch circuits. Listed to UL1953 which has minimum spacing requirements at 600V of at least 1" through air and 2" over surface
- Small footprint saves panel space. Stack side by side and still meet 1" and 2" spacing requirements
- For 2D and 3D CAD drawings visit [www.cooperbussmann.com](http://www.cooperbussmann.com)



## Electrical

- 600Vac or dc (UL 1953), 690Vac or dc (IEC)
- Short-Circuit Current Ratings up to 200kA, see table below
- Ampacities up to 760 Amps
- 75°C rated connectors
- CU Wire range 14 AWG to 500 kcmil or 2.5 to 240 mm<sup>2</sup>

## Mechanical

- DIN rail or panel mount; PDBFS330 & PDBFS504 panel mount only
- Captive termination screws; screws do not get misplaced
- Wire ready: captive termination screws shipped backed out to save time on conductor installation
- Sliding DIN rail latch for easy mounting
- Single pole, gang mountable for multiple pole applications with interlocking dovetail accessory (optional Part 2A1279) One pin interlocks two units, two pins to interlock three units (see illustration on page 6)
- Flammability, UL 94V0
- Tin-plated AL connectors suitable for CU conductors
- Elongated hole for panel mounting; easier mounting with greater flexibility in matching up with drilled panel holes
- DIN rail end anchors required to prevent damage to block when torquing, anchors not offered by Cooper Bussmann

## Agency/Standards

- UL Listed 1953, Guide QPQS, File E256146
- CSA Certified, Class 6228-01, File 15364
- CE component IEC 60947-7-1
- IEC 60529, IP-20 (Finger Safe) under specific conditions, see page 8

## Series PDBFS

Electrical		Terminal Copper Conductor Capability			Short-Circuit Current Rating Data							
		Line	Load	Configuration	Conductors		Max Fuse Class & Amp**				SCCR	
Catalog Number	Amps	Wire Range	Wire Range	Openings per Pole		Line	Load	J	T	RK1		RK5
(All Single Pole)				Line	Load	AWG or kcmil	AWG or kcmil	LPJ	JJS JJN	LPS-RK LPN-RK	FRS-R FRN-R	
PDBFS204	175A	2/0 to 8 AWG 70 to 10 mm <sup>2</sup>	2/0 to 8 AWG 70 to 10 mm <sup>2</sup>	○	○	2/0 to 8	2/0 to 8	200	200	100	60	200kA
PDBFS220	175A	2/0 to 8 AWG 70 to 10 mm <sup>2</sup>	4 to 14 AWG 25 to 2.5 mm <sup>2</sup>	○	○○	2/0 to 8	4 to 12	200	200	100	60	200kA
							4 to 14	175	175	100	60	100kA
								200	200	100	60	50kA
PDBFS303	310A	350kcmil to 6 AWG 150 to 16 mm <sup>2</sup>	350kcmil to 6 AWG 150 to 16 mm <sup>2</sup>	○	○	350 to 6	350 to 6	400	400	200	100	200kA
PDBFS330	380A	500kcmil to 6 AWG 240 to 16 mm <sup>2</sup>	2 to 14 AWG 35 to 2.5 mm <sup>2</sup>	○	○○○	500 to 6	2 to 6	400	400	200	100	200kA
							2 to 14	200	200	100	30	50kA
								175	175	100	30	100kA
PDBFS377	570A	300kcmil to 4 AWG 150 to 12 mm <sup>2</sup>	4 to 14 AWG 25 to 2.5 mm <sup>2</sup>	○○	○○○○	300	4 to 8	600	600	400	200	200kA
						300 to 4	4	600	600	400	200	50kA
							4 to 14	200	200	100	30	50kA
PDBFS500	620A	350kcmil to 4 AWG 185 to 12 mm <sup>2</sup>	350kcmil to 4 AWG 185 to 12 mm <sup>2</sup>	○○	○○	350	350	600	600	400	200	200kA
						350 to 4	350 to 4	600	800*	600	200	100kA
							500	500	600	800*	600	600
PDBFS504	760A	500kcmil to 6 AWG 240 to 16 mm <sup>2</sup>	500kcmil to 6 AWG 240 to 16 mm <sup>2</sup>	○○	○○	500	500	600	800*	600	400	200kA
						500 to 6	500 to 6	600	800*	600	600	100kA
									600	600	400	200

Ampacities 75C per NEC® Table 310.16 and UL508A Table 28.1

\*Class L 800A (KRP-C 800\_SP) or less fuses suitable for this particular SCCR case.

\*\* Class G 60A (SC-60) or less or Class CC 30A (LP-CC-30, FNQ-R-30, KTK-R-30) or less are suitable for all SCCRs in this table.

# Series PDBFS Enclosed Power Distribution Blocks

Dimensions in[mm]								
Part No.	Width	Length	Height	D	E	F	G	H
	A	B	C					
PDBFS204	1.030[26.16]	3.372[94.80]	2.146[54.50]	3.550[90.17]	2.905[73.79]	0.197[5.00]	0.197[5.00]	N/A
PDBFS220	1.030[26.16]	3.372[94.80]	2.146[54.50]	3.550[90.17]	2.905[73.79]	0.197[5.00]	0.197[5.00]	N/A
PDBFS303	1.550[39.37]	4.665[118.50]	2.874[73.00]	4.475[113.67]	3.810[96.77]	0.197[5.00]	0.236[6.00]	N/A
PDBFS330	1.550[39.37]	4.665[118.50]	2.950[74.93]	4.475[113.67]	3.810[96.77]	0.197[5.00]	0.236[6.00]	N/A
PDBFS377	1.875[47.62]	4.665[118.50]	2.933[74.50]	4.475[113.67]	3.810[96.77]	0.197[5.00]	0.236[6.00]	N/A
PDBFS520	2.380[60.45]	4.665[118.50]	2.598[66.00]	4.475[113.67]	3.810[96.77]	0.197[5.00]	0.236[6.00]	N/A
PDBFS504	2.560[65.02]	4.665[118.50]	3.150[80.00]	4.475[113.67]	3.810[96.77]	0.197[5.00]	0.236[6.00]	46.00[1.811]

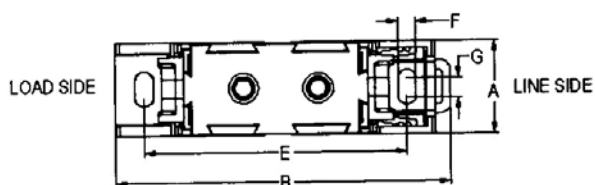

PDBFS204

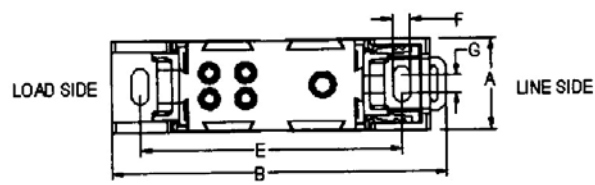

PDBFS220

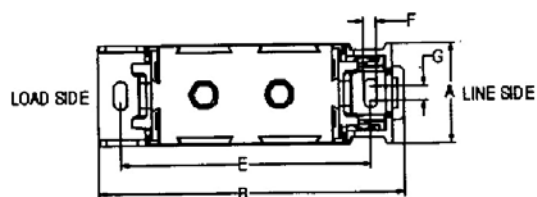

PDBFS303

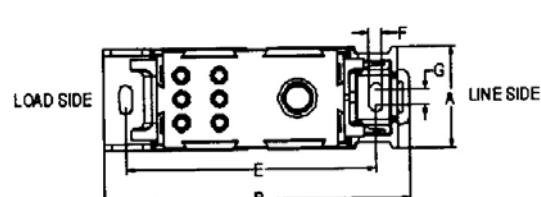

PDBFS330

# Series PDBFS Enclosed Power Distribution Blocks

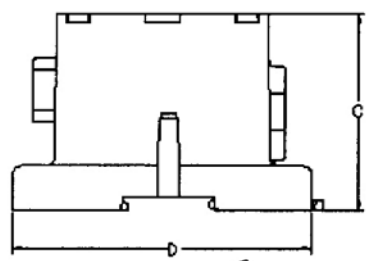
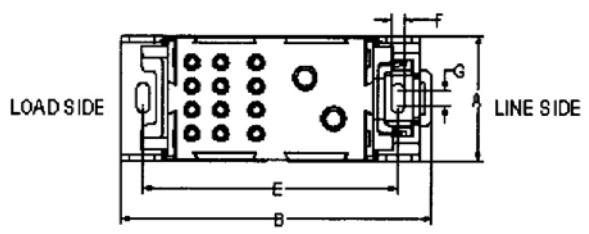

PDBFS377

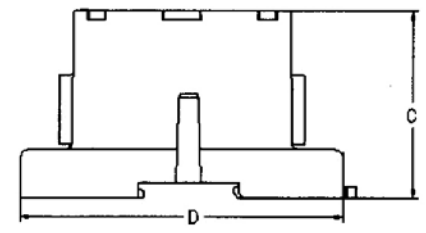
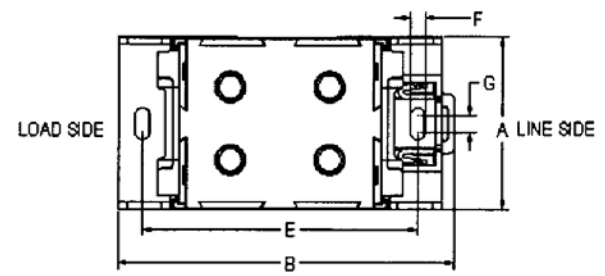

PDBFS500

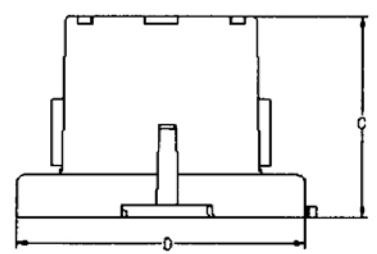
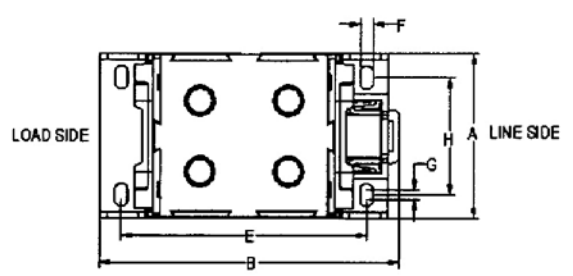

PDBFS504

# Series PDBFS Enclosed Power Distribution Blocks

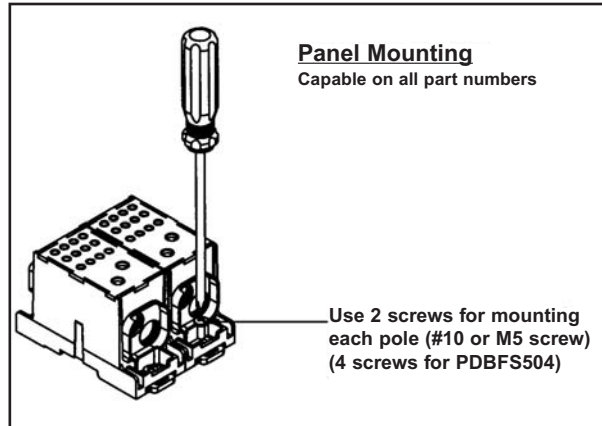

**OR**

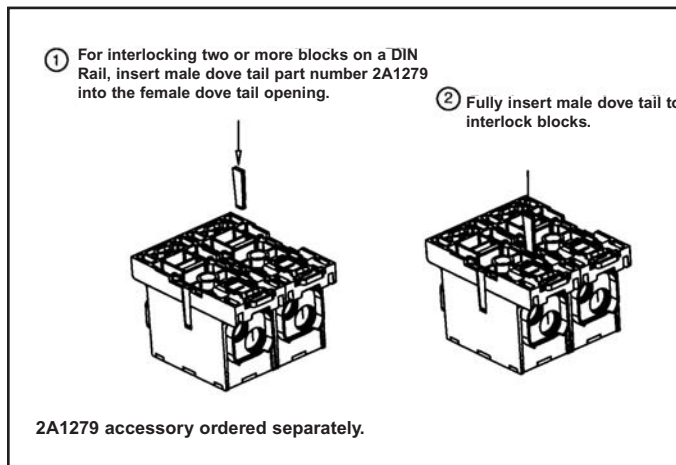
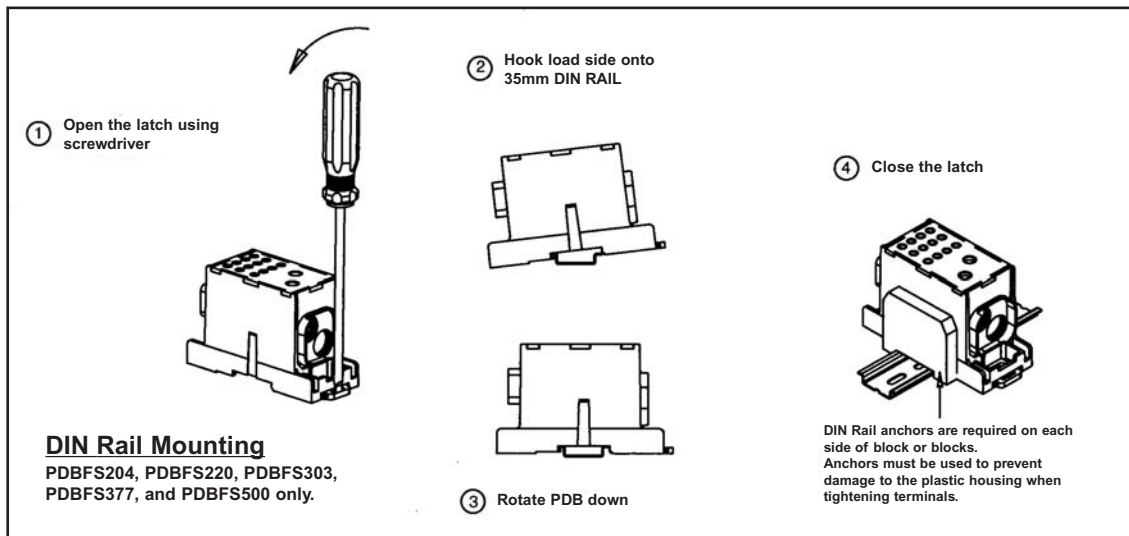

# Series PDBFS Enclosed Power Distribution Blocks

## Series PDBFS

Part Number	Line				Load			
	CU Wire Range	Torque Lb-in (Nm)	Trim Length in (mm)	Hex Key	CU Wire Range	Torque Lb-in (Nm)	Trim Length in (mm)	Hex Key
PDBFS204	2/0 to 8 AWG 70 to 10mm <sup>2</sup>	110 (12.4)	0.850 (21.6)	3/16"	2/0 to 8 AWG 70 to 10mm <sup>2</sup>	110 (12.4)	0.970 (24.6)	3/16"
PDBFS220	2/0 to 8 AWG 70 to 10mm <sup>2</sup>	120 (13.6)	0.750 (19.0)	3/16"	4 to 6 AWG 25 to 16mm <sup>2</sup>	35 (4.0)	0.550 (14.0) top row, 0.850 (21.6) bottom row	1/8"
					8 AWG 10mm <sup>2</sup>	25 (2.8)		
					10 to 14 AWG 6 to 2.5mm <sup>2</sup>	20 (2.3)		
PDBFS303	350 Kcmil to 6 AWG 150 to 16mm <sup>2</sup>	275 (31.1)	1.350 (34.3)	5/16"	350 Kcmil to 6 AWG 150 to 16mm <sup>2</sup>	275 (31.1)	1.250 (31.8)	5/16"
PDBFS330	500 Kcmil to 6 AWG 240 to 16mm <sup>2</sup>	500 (56.5)	1.250 (31.8)	3/8"	2 to 3 AWG 35mm <sup>2</sup>	50 (5.7)	0.590 (15.0) top row 1.200 (30.5) bottom row	1/8"
					4 to 6 AWG 25 to 16mm <sup>2</sup>	45 (5.1)		
					8 AWG 10mm <sup>2</sup>	40 (4.5)		
					10 to 14 AWG 6 to 2.5mm <sup>2</sup>	35 (4.0)		
PDBFS377	300 Kcmil to 4 AWG 150 to 25mm <sup>2</sup>	275 (31.1)	1.15 (29.2) top row 1.400 (35.6) bottom row	1/4"	4 to 6 AWG 25 to 16mm <sup>2</sup>	35 (4.0)	0.550 (14.0) top row, 1.00 (25.4) middle row 1.220 (31.0) bottom row	1/8"
					8 AWG 10mm <sup>2</sup>	25 (2.8)		
					10 to 14 AWG 6 to 2.5mm <sup>2</sup>	20 (2.3)		
PDBFS500	350 Kcmil to 4 AWG 185 to 25mm <sup>2</sup>	275 (31.1)	1.250 (31.8)	5/16"	350 Kcmil to 4 AWG 185 to 25mm <sup>2</sup>	275 (31.1)	1.250 (31.8)	5/16"
PDBFS504	500 Kcmil to 6 AWG 240 to 16mm <sup>2</sup>	500 (56.5)	1.250 (31.8)	3/8"	500 Kcmil to 6 AWG 240 to 16mm <sup>2</sup>	500 (56.5)	1.250 (31.8)	3/8"

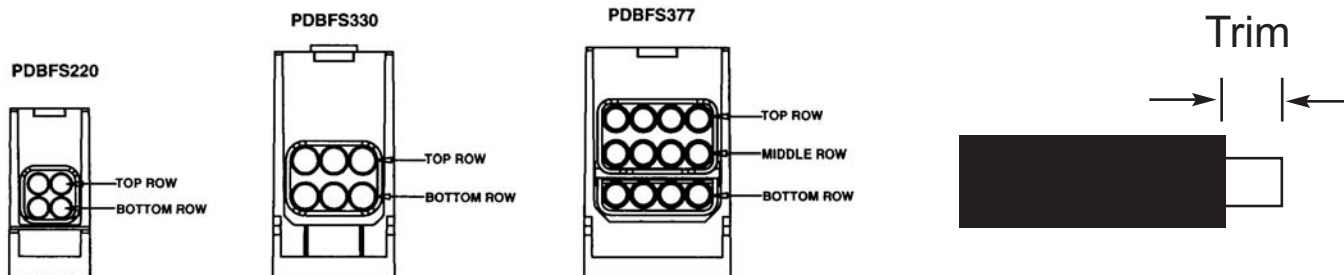

Wire Connector Hole Diameter		
Part Number	Line	Load
	in (mm)	in (mm)
PDBFS204	0.450 (11.5)	0.450 (11.5)
PDBFS220	0.450 (11.5)	0.246 (6.25)
PDBFS303	0.720 (18.3)	0.720 (18.3)
PDBFS330	0.870 (22.1)	0.314 (8.0)
PDBFS377	0.687 (17.5)	0.265 (6.7)
PDBFS500	0.718 (18.2)	0.718 (18.2)
PDBFS504	0.875 (22.2)	0.875 (22.2)

Part No.	Minimum Enclosure Size
PDBFS204	16" X 16" X 6.75"
PDBFS220	16" X 16" X 6.75"
PDBFS303	36" X 30" X 12.625"
PDBFS330	24" X 20" X 6.75"
PDBFS377	24" X 20" X 6.75"
PDBFS500	36" X 30" X 12.625"
PDBFS504	36" X 30" X 12.625"

# Series PDBFS Enclosed Power Distribution Blocks

## Specific Conditions to Achieve IP-20 Finger-Safe Status for Series PDBFS

Part Number	Line				Load			
	Trim Length in (mm)	Installed Wire	IP-20		Trim Length in (mm)	Installed Wire	IP-20	
			Conductor Openings	Screw Opening			Conductor Openings	Screw Opening
PDBFS204	0.850 (21.6)	2/0 to 8 AWG 70 to 10mm <sup>2</sup>	Yes	Yes	0.970 (24.6)	2/0 to 8 AWG 70 to 10mm <sup>2</sup>	Yes	Yes
PDBFS220	0.750 (19.0)	2/0 to 8 AWG 70 to 10mm <sup>2</sup>	Yes	Yes	0.550 (14.0) top row, 0.850 (21.6) bottom row	4 to 14 AWG 25 to 2.5mm <sup>2</sup>	Yes	Yes
						screws fully opened	N/A	Yes
						no wire in hole	No	N/A
PDBFS303	1.350 (34.3)	350 Kcmil to 2/0 AWG 150 to 70mm <sup>2</sup>	Yes	Yes	1.250 (31.8)	350 Kcmil to 2/0 AWG 150 to 70mm <sup>2</sup>	Yes	Yes
		1/0 to 6 AWG 50 to 16mm <sup>2</sup>	No	Yes		1/0 to 6 AWG 50 to 16mm <sup>2</sup>	No	Yes
PDBFS330	1.250 (31.8)	500 to 250 Kcmil 240 to 150mm <sup>2</sup>	Yes	Yes	0.590 (15.0) top row, 1.200 (30.5) bottom row	2 to 14 AWG 35 to 2.5mm <sup>2</sup>	Yes	Yes
		4/0 to 6 AWG 120 to 16mm <sup>2</sup>	No	Yes		screws fully opened	N/A	Yes
						no wire in hole	No	N/A
PDBFS377	1.15 (29.2) top row, 1.400 (35.6) bottom row	300 Kcmil to 4/0 AWG 150 to 120mm <sup>2</sup>	Yes	Yes	0.550 (14.0) top row, 1.00 (25.4) middle row, 1.220 (31.0) bottom row	4 to 14 AWG 25 to 2.5mm <sup>2</sup>	Yes	Yes
		3/0 to 4 AWG 95 to 25mm <sup>2</sup>	No	Yes		screws fully opened	N/A	Yes
		screws fully opened	N/A	No		no wire in hole	Yes	N/A
		no wire in hole	No	N/A				
PDBFS500	1.250 (31.8)	350 Kcmil to 2/0 AWG 185 to 70mm <sup>2</sup>	Yes	Yes	1.250 (31.8)	350 Kcmil to 2/0 AWG 185 to 70mm <sup>2</sup>	Yes	Yes
		1/0 to 4 AWG 50 to 25mm <sup>2</sup>	No	Yes		1/0 to 4 AWG 50 to 25mm <sup>2</sup>	No	Yes
		screws fully opened	N/A	No		screws fully opened	N/A	No
		no wire in hole	No	N/A		no wire in hole	No	N/A
PDBFS504	1.250 (31.8)	500 to 350 Kcmil 240 to 185mm <sup>2</sup>	Yes	Yes	1.250 (31.8)	500 to 350 Kcmil 240 to 185mm <sup>2</sup>	Yes	Yes
		300 Kcmil to 6 AWG 150 to 16mm <sup>2</sup>	No	Yes		300 Kcmil to 6 AWG 150 to 16mm <sup>2</sup>	No	Yes
		screws fully opened	N/A	No		screws fully opened	N/A	No
		no wire in hole	No	N/A		no wire in hole	No	N/A



# Series PDB Power Distribution Blocks



### Feature/Benefits

- High Short-Circuit Current Ratings up to 200kA  
PDBs do not have to be a weak link in achieving high SCCR for an industrial control panel
- Suitable for installation in wireways (with optional covers) and industrial control panel feeder and branch circuits. Listed to UL1953 which has minimum spacing requirements at 600V of at least 1" through air and 2"

### Agency/Standards

- UL Listed 1953, Guide QPQS, File E256146

### Electrical

- 600Vac or dc (UL 1953)
- Short-Circuit Current Ratings up to 200kA, see table
- 75°C rated connectors, ampacities up to 310A
- Wire range 14 AWG to 350 kcmil CU
- Spacing between uninsulated opposite polarities or ground meets UL 1953 which requires at least 1" through air and 2" over surface for 301 to 600V

### Mechanical

- Panel mount
- Flammability, UL 94V0
- Tin-plated AL connectors suitable for CU conductors

## Series PDB

		Terminal Copper Conductor Capability			Short-Circuit Current Rating Data							
		Line	Load	Configuration	Conductors		Max Fuse Class & Amp**				SCCR	
Part Number	Amps	Wire Range	Wire Range	Openings per Pole		Line AWG or kcmil	Load AWG or kcmil	J LPJ	T JJS JJN	RK1 LPS-RK LPN-RK		RK5 FRS-R FRN-R
				Line	Load							
PDB204-1 PDB204-3	175A	2/0 to 8 AWG	2/0 to 8 AWG	○	○	2/0 to 8	2/0 to 8	200	200	200	60	200kA
PDB220-1 PDB220-3	175A	2/0 to 8 AWG	4 to 14 AWG	○	○○	2/0 to 8	4 to 12	200	200	200	60	200kA
							4 to 14	175	175	100	60	100kA
								200	200	100	60	50kA
PDB280-1 PDB280-3	175A	2/0 to 8 AWG	1/4-20 X 3/4 STUD	○	⬡	2/0 to 8	Stud	200	200	100	60	200kA
PDB321-1 PDB321-2 PDB321-3	175A	2/0 to 8 AWG	4 to 14 AWG	○	○○	2/0 to 8	4 to 12	400	400	200	100	200kA
								400	400	400	100	100kA
							4 to 14	175	175	100	60	100kA
PDB323-1 PDB323-3	310A	350kcmil to 4 AWG	4 to 12 AWG	○	○○	350 to 4	4 to 8	400	400	200	100	200kA
								400	400	400	100	100kA
							4 to 12	175	175	100	60	100kA
PDB370-1 PDB370-3	310A	350kcmil to 4 AWG	4 to 14 AWG	○	○○○	350 to 4	4 to 8	400	400	200	100	200kA
								400	400	400	100	100kA
							4 to 14	175	175	100	60	100kA
PDB371-1 PDB371-3	310A	350kcmil to 4 AWG	(6) 2 to 12 AWG (3) 1/0 to 12	○	○○○	350 to 4	1/0 to 6	400	400	200	100	200kA
								400	400	400	100	100kA
							4 to 12	175	175	100	60	100kA

Ampacities 75C per NEC® Table 310.16 and UL508A Table 28.1

\*\* Class G 60A (SC-60) or less or Class CC 30A (LP-CC-30, FNQ-R-30, KTK-R-30) or less are suitable for all SCCR in this table.

These blocks available in 1 or 3 poles. PDB321 available in 1, 2, and 3 poles.

Part Number:

Example: PDB204-1 = single pole

PDB204-3 = three pole

# Series PDB Power Distribution Blocks

Part Numbers	Dimensions in [mm]					
	Width	Length	Height			
	A	B	C	D	E	F (Hole)
PDB204-3, PDB220-3, PDB280-3	4.27 [108.3]	2.88 [73.2]	2.13 [54.0]	1.62 [41.1]	2.25 [57.2]	0.22 [5.7]
PDB323-3, PDB370-3, PDB371-3	6.00 [152.4]	5.50 [139.7]	3.70 [93.9]	3.25 [82.6]	4.75 [120.7]	0.22 [5.7]
PDB323-1, PDB370-1, PDB371-1	1.96 [49.8]	3.38 [85.7]	3.32 [85.7]	—		0.21 [2.5] X 0.41 [10.4]
PDB204-1, PDB220-1, PDB280-1	1.07 [27.2]	2.88 [73.2]	1.75 [44.5]		2.25 [57.2]	0.20 [5.1]
PDB321-1	1.96 [49.8]	4.00 [101.6]	3.32 [84.3]	1.62 [41.1]	3.37 [85.6]	0.21 [5.3] X 0.41 [10.4]
PDB321-2	3.58 [90.9]	4.00 [101.6]	3.32 [84.3]	1.62 [41.1]	3.37 [85.6]	0.21 [5.3] X 0.41 [10.4]
PDB321-3	5.20 [132.1]	4.00 [101.6]	3.32 [84.3]	1.62 [41.1]	3.37 [85.6]	0.21 [5.3] X 0.41 [10.4]

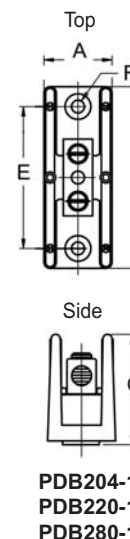
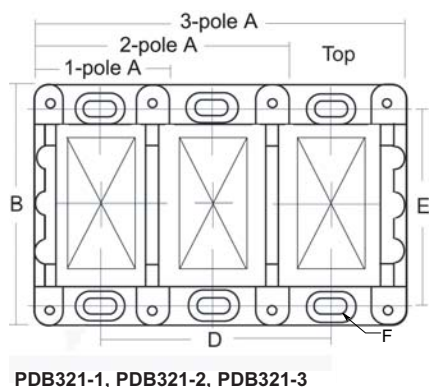
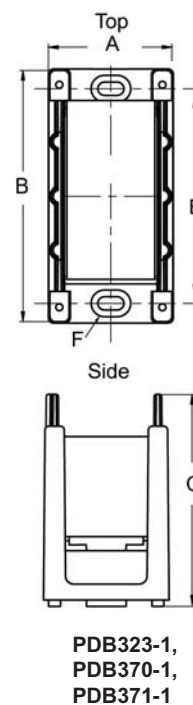
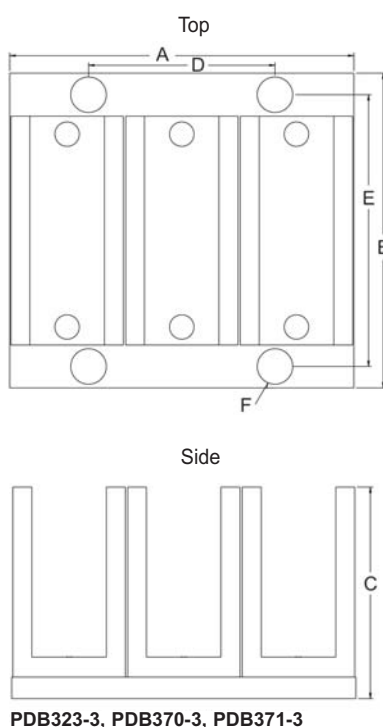
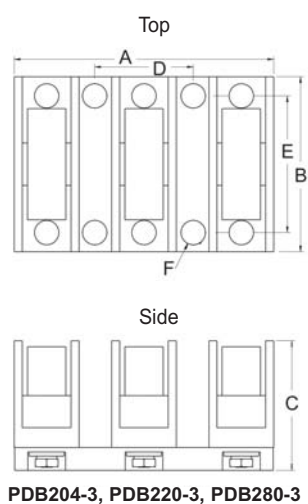

# Series PDB Power Distribution Blocks

## Optional covers

Covers are ordered for each individual pole, i.e. three

1-pole covers for 3-pole block, see table A.

Except PDB321 blocks have one cover for 1, 2 or 3 pole versions, see table B. (*Shipped with mounting screws*)

**Table A**

Block	Cover
PDB2XX-(pole):	CPB162-1
PDB3XX-(pole):	CPDB-1

**Table B**

Block	Cover
PDB321-1	CPDB-1
PDB321-2	CPDB-2
PDB321-3	CPDB-3

## Series 163 Cover

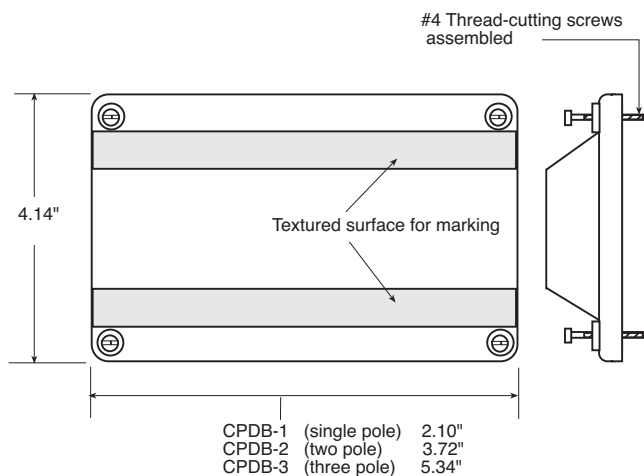

## Series 162 Cover

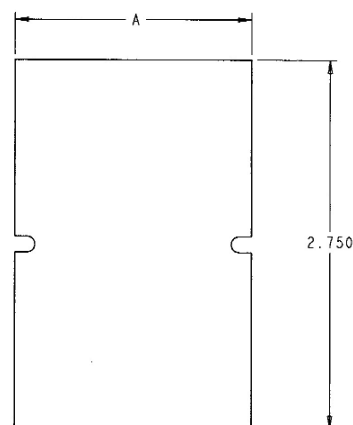

**Flat Cover**

Part Number	"A" Dimension
CPB162-1	0.94"
CPB162-2	1.75"
CPB162-3	2.56"

Part No.	Minimum Enclosure Size
PDB204-1, -3	16" X 16" X 6.75"
PDB220-1, -3	16" X 16" X 6.75"
PDB280-1, -3	16" X 16" X 6.75"
PDB321-1, -2, -3	24" X 20" X 6.75"
PDB323-1, -3	24" X 20" X 6.75"
PDB370-1, -3	24" X 20" X 6.75"
PDB371-1, -3	24" X 20" X 6.75"

# Series PDB Power Distribution Blocks

Part Number	Line				Load			
	CU Wire Range	Torque Lb-in (Nm)	Trim Length in (mm)	Hex Key	CU Wire Range	Torque Lb-in (Nm)	Trim Length in (mm)	Hex Key, Slot, Stud
PDB204-1, -3	2/0 to 8 AWG 70 to 10mm <sup>2</sup>	110 (12.4)	0.700 (17.8)	3/16"	2/0 to 8 AWG 70 to 10mm <sup>2</sup>	110 (12.4)	0.700 (17.8)	3/16" Hex
PDB220-1, -3	2/0 to 8 AWG 70 to 10mm <sup>2</sup>	120 (13.6)	0.670 (17.0)	3/16"	4 to 6 AWG 25 to 16mm <sup>2</sup>	35 (4.0)	0.470 (11.9) top row, 0.780 (19.8) bottom row	Slot
					8 AWG 10mm <sup>2</sup>	25 (2.8)		
					10 to 14 AWG 6 to 2.5mm <sup>2</sup>	20 (2.3)		
PDB280-1, -3	2/0 to 8 AWG 70 to 10mm <sup>2</sup>	120 (13.6)	0.670 (17.0)	3/16"	N/A	50 (5.7)	N/A	1/4 - 20 Stud
PDB321-1, -2, -3	2/0 to 8 AWG 70 to 10mm <sup>2</sup>	120 (13.6)	0.700 (17.8)	3/16"	4 to 6 AWG 25 to 16mm <sup>2</sup>	35 (4.0)	0.480 (12.2) top row, 0.800 (20.3) bottom row	Slot
					8 AWG 10mm <sup>2</sup>	25 (2.8)		
					10 to 14 AWG 6 to 2.5mm <sup>2</sup>	20 (2.3)		
PDB323-1, -3	350 Kcmil to 4 AWG 185 to 25mm <sup>2</sup>	275 (31.1)	0.900 (22.9)	5/16"	4 to 6 AWG 25 to 16mm <sup>2</sup>	35 (4.0)	1.00 (25.4) top row, 0.450 (11.43) bottom row	Slot
					8 AWG 10mm <sup>2</sup>	25 (2.8)		
					10 to 12 AWG 6 to 4mm <sup>2</sup>	20 (2.3)		
PDB370-1, -3	350 Kcmil to 4 AWG 185 to 25mm <sup>2</sup>	275 (31.1)	0.900 (22.9)	5/16"	4 to 6 AWG 25 to 16mm <sup>2</sup>	35 (4.0)	0.450 (11.4) top row 0.630 (16.0) middle row, 0.920 (23.4) bottom row	Slot
					8 AWG 10mm <sup>2</sup>	25 (2.8)		
					10 to 14 AWG 6 to 2.5mm <sup>2</sup>	20 (2.3)		
PDB371-1, -3	350 Kcmil to 4 AWG 185 to 25mm <sup>2</sup>	275 (31.1)	0.900 (22.9)	5/16"	2 to 3 AWG 35mm <sup>2</sup>	50 (5.7)	0.450 (11.4) top row 0.630 (16.0) middle row, 0.920 (23.4) bottom row	Slot top row Slot middle row, 3/16" Hex bottom row
					4 to 6 AWG 25 to 16mm <sup>2</sup>	45 (5.1)		
					8 AWG 10mm <sup>2</sup>	40 (4.5)		
					10 to 12 AWG 6 to 4mm <sup>2</sup>	35 (4.0)		

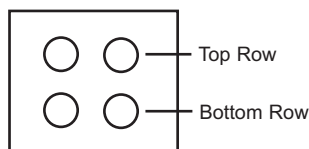

PDB220-1, -3

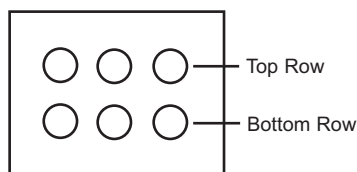

PDB321-1, -2, -3  
PDB323-1, -3

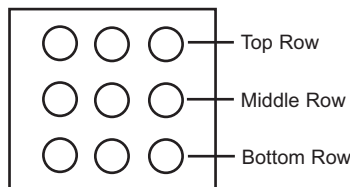

PDB370-1, -3  
PDB371-1, -3

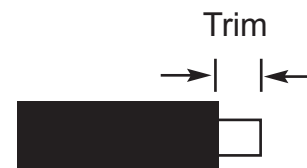

# Series 16XXX\_UL Terminal Blocks

## Feature/Benefits

- High Short-Circuit Current Ratings up to 200kA
- UL1059 Recognition

## Agency/Standards

- UL 1059 Recognized, Guide XCFR2, File E221592
- General Industry Class per UL 1059, usage category C
- CSA Certified, Class 6228-01, File 15364

## Electrical

- 600Vac or dc
- Short Circuit Current Ratings up to 200kA, see table
- Ampacities up to 310 Amps
- 75°C rated connectors
- Wire range 14 AWG to 350 kcmil CU

## Mechanical

- Panel mount
- Flammability, UL 94V0
- Tin-plated AL connectors suitable for CU conductors



Series 162 and 163

## Series 16XXX\_UL

Part Number	Amps	Terminal Copper Conductor Capability			Short-Circuit Current Rating Data						
		Line	Load	Configuration	Conductors		Max Fuse Class & Amp**				SCCR
		Wire Range	Wire Range	Openings per Pole	Line	Load	J	T	RK1	RK5	
				Line Load	AWG or kcmil	AWG or kcmil	LPJ	JJS JJN	LPS-RK LPN-RK	FRS-R FRN-R	
16204-1UL, -2UL, -3UL	175A	2/0 to 8 AWG	2/0 to 8 AWG		2/0 to 8	2/0 to 8	200	200	200	60	200kA
16220-1UL, -2UL, -3UL	175A	2/0 to 8 AWG	4 to 14 AWG		2/0 to 8	4 to 12	200	200	200	60	200kA
						4 to 14	175	175	100	60	100kA
16280-1UL, -2UL, -3UL	175A	2/0 to 8 AWG	1/4-20 X 3/4 STUD		2/0 to 8	Stud	200	200	100	60	200kA
16321-1UL, -2UL, -3UL	175A	2/0 to 8 AWG	4 to 14 AWG		2/0 to 8	4 to 12	400	400	200	100	200kA
							400	400	400	100	100kA
						4 to 14	175	175	100	60	100kA
16323-1UL, -2UL, -3UL	310A	350kcmil to 4 AWG	4 to 12 AWG		350 to 4	4 to 8	400	400	200	100	200kA
							400	400	400	100	100kA
						4 to 12	175	175	100	60	100kA
16370-1UL, -2UL, -3UL	310A	350kcmil to 4 AWG	4 to 14 AWG		350 to 4	4 to 8	400	400	200	100	200kA
						4 to 14	175	175	100	60	100kA
16371-1UL, -2UL, -3UL	310A	350kcmil to 4 AWG	(6) 2 to 12 AWG (3) 1/0 to 12		350 to 4	1/0 to 6	400	400	200	100	200kA
						4 to 12	175	175	100	60	100kA

Ampacities 75C per NEC® Table 310.16 and UL508A Table 28.1

\*\* Class G 60A (SC-60) or less or Class CC 30A (LP-CC-30, FNQ-R-30, KTK-R-30) or less are suitable for all the SCCR in this table.

These blocks available in 1, 2, or 3 poles

Part Number:

Example: 16204-1UL = single pole

16204-3UL = three pole

Part No.	Minimum Enclosure Size
16204-1UL, -2UL, -3UL	16" X 16" X 6.75"
16220-1UL, -2UL, -3UL	16" X 16" X 6.75"
16280-1UL, -2UL, -3UL	16" X 16" X 6.75"
16321-1UL, -2UL, -3UL	24" X 20" X 6.75"
16323-1UL, -2UL, -3UL	24" X 20" X 6.75"
16370-1UL, -2UL, -3UL	24" X 20" X 6.75"
16371-1UL, -2UL, -3UL	24" X 20" X 6.75"

# Series 16XXX\_UL Terminal Blocks

## Series 16XXX-XUL

Part Number	Line				Load			
	CU Wire Range	Torque Lb-in (Nm)	Trim Length in (mm)	Hex Key	CU Wire Range	Torque Lb-in (Nm)	Trim Length in (mm)	Hex Key, Slot, Stud
16204-1UL, -2UL, -3UL	2/0 to 8 AWG 70 to 10mm <sup>2</sup>	110 (12.4)	0.700 (17.8)	3/16"	2/0 to 8 AWG 70 to 10mm <sup>2</sup>	110 (12.4)	0.700 (17.8)	3/16" Hex
16220-1UL, -2UL, -3UL	2/0 to 8 AWG 70 to 10mm <sup>2</sup>	120 (13.6)	0.670 (17.0)	3/16"	4 to 6 AWG 25 to 16mm <sup>2</sup>	35 (4.0)	0.470 (11.9) top row, 0.780 (19.8) bottom row	Slot
					8 AWG 10mm <sup>2</sup>	25 (2.8)		
					10 to 14 AWG 6 to 2.5mm <sup>2</sup>	20 (2.3)		
16280-1UL, -2UL, -3UL	2/0 to 8 AWG 70 to 10mm <sup>2</sup>	120 (13.6)	0.670 (17.0)	3/16"	N/A	50 (5.7)	N/A	1/4 - 20 Stud
16321-1UL, -2UL, -3UL	2/0 to 8 AWG 70 to 10mm <sup>2</sup>	120 (13.6)	0.700 (17.8)	3/16"	4 to 6 AWG 25 to 16mm <sup>2</sup>	35 (4.0)	0.480 (12.2) top row, 0.800 (20.3) bottom row	Slot
					8 AWG 10mm <sup>2</sup>	25 (2.8)		
					10 to 14 AWG 6 to 2.5mm <sup>2</sup>	20 (2.3)		
16323-1UL, -2UL, -3UL	350 Kcmil to 4 AWG 185 to 25mm <sup>2</sup>	275 (31.1)	0.900 (22.9)	5/16"	4 to 6 AWG 25 to 16mm <sup>2</sup>	35 (4.0)	1.00 (25.4) top row, 0.450 (11.43) bottom row	Slot
					8 AWG 10mm <sup>2</sup>	25 (2.8)		
					10 to 12 AWG 6 to 4mm <sup>2</sup>	20 (2.3)		
16370-1UL, -2UL, -3UL	350 Kcmil to 4 AWG 185 to 25mm <sup>2</sup>	275 (31.1)	0.900 (22.9)	5/16"	4 to 6 AWG 25 to 16mm <sup>2</sup>	35 (4.0)	0.450 (11.4) top row 0.630 (16.0) middle row, 0.920 (23.4) bottom row	Slot
					8 AWG 10mm <sup>2</sup>	25 (2.8)		
					10 to 14 AWG 6 to 2.5mm <sup>2</sup>	20 (2.3)		
16371-1UL, -2UL, -3UL	350 Kcmil to 4 AWG 185 to 25mm <sup>2</sup>	275 (31.1)	0.900 (22.9)	5/16"	2 to 3 AWG 35mm <sup>2</sup>	50 (5.7)	0.450 (11.4) top row 0.630 (16.0) middle row, 0.920 (23.4) bottom row	Slot top row Slot middle row, 3/16" Hex bottom row
					4 to 6 AWG 25 to 16mm <sup>2</sup>	45 (5.1)		
					8 AWG 10mm <sup>2</sup>	40 (4.5)		
					10 to 12 AWG 6 to 4mm <sup>2</sup>	35 (4.0)		

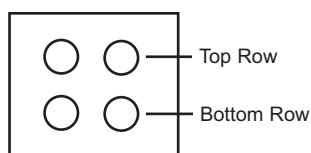

16220-1UL, -2UL, -3UL

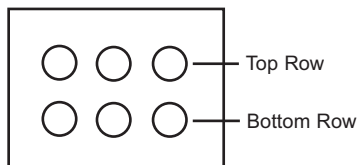

16321-1UL, -2UL, -3UL  
16323-1UL, -2UL, -3UL

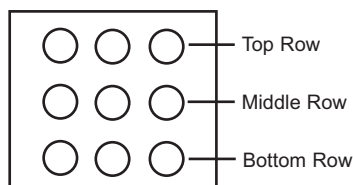

16370-1UL, -2UL, -3UL  
16371-1UL, -2UL, -3UL

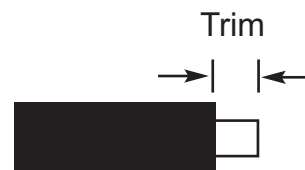

# Series 16XXX\_UL Terminal Blocks

## Dimensions for Series 162 & 163 (Inches)

Part No.	Width			Length	Height	D	E	F	G	H	J	K	L
	A1	A2	A3	B	C								
162	1.06	1.88	2.60	2.85	1.75	0.81	2.25	0.53	0.31	0.84	0.31	0.20	0.42
163	1.96	3.58	5.20	4.0	3.32	1.62	3.37	—	—	—	—	Slot 0.20" wide x 0.41" long	Slot 0.42" wide x 0.62" long

### Series 162 (Available 1, 2, and 3 pole)

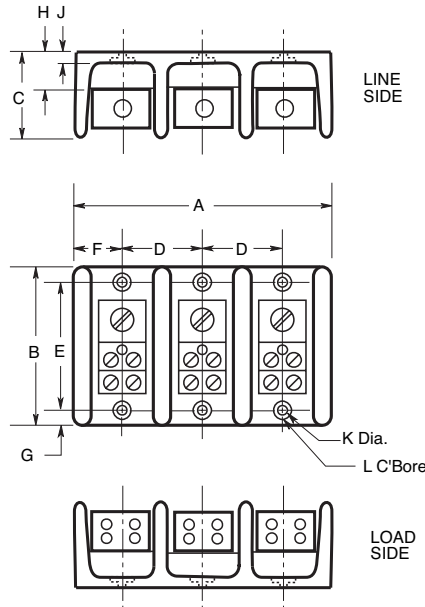

### Series 163 (Available 1, 2, and 3 pole)

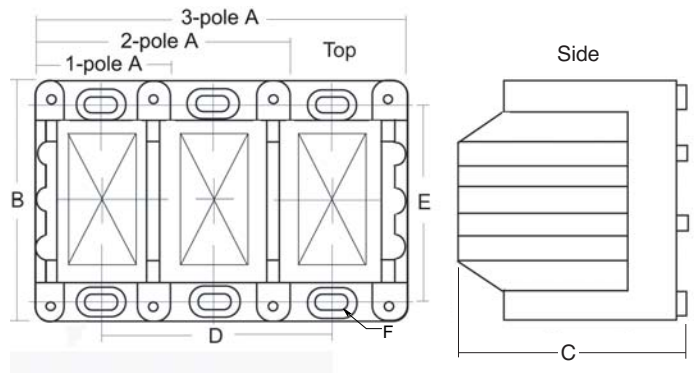

### Optional covers

Block	Cover
Series 162:	CPD162-(pole)*
Series 163:	CPDB-(pole)*

\*Provided with mounting screws

### Series 163 Cover

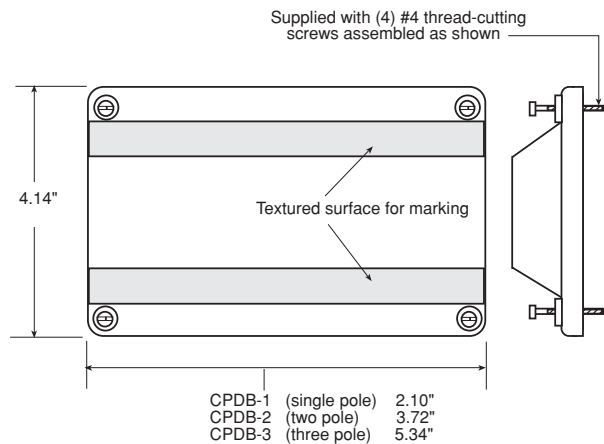

### Series 162 Cover

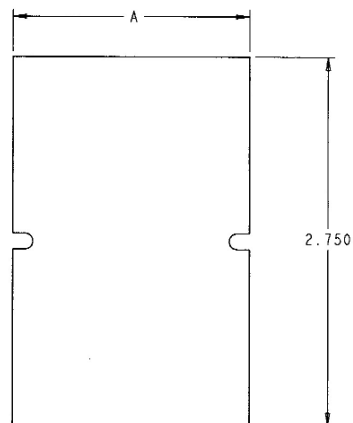

Flat Cover

Part Number	"A" Dimension
CPB162-1	0.94"
CPB162-2	1.75"
CPB162-3	2.56"

# Terminal Blocks With High Short-Circuit Current Ratings

Part Number	Amps	CU Wire Range Line & Load	Torque lb-in MAX.	Short-Circuit Current Rating Data					SCCR	Minimum Enclosure Size
				(1) CU Wire Range AWG	Max. Fuse Class and Amp**					
					J LPJ	T JJS JJN	RK1 LPS-RK LPN-RK	RK5 FRS-R FRN-R		
14002-3-UL	115	2 to 3 AWG	50	2 to 8	200	200	100	60	200kA	8" x 8" x 4"
		4 to 6 AWG 8 AWG 10 to 14 AWG	45 35 35	2 to 14	175	175	100	60	100kA	
TB300-03SP-UL	30	10 to 18 AWG	16	10 to 18	60	60	60	—	100kA	8" x 8" x 4"
NDN63-WH-UL	65	6 to 18 AWG	35	6 to 18	100	100	60	30	100kA	8" x 8" x 4"
NDN111-WH-UL	90	2 to 18 AWG	32	2 to 18	200	200	200	60	100kA	8" x 8" x 4"

\*\*Class G 60A (SC-60) or less or Class CC 30A (LP-CC-30, FNQ-R-30, KTK-R-30) or less are suitable for all SCCR in this table

## 14002-3-UL Barrier Terminal Block

### Agency/Standards

- UL 1059 Recognized, Guide XCFR2, File E62622
- General Industry Class per UL 1059, usage category C

### Electrical

- 600Vac or dc
- Short-Circuit Current Rating up to 200kA, See table
- 75°C rated connectors, 115A ampacity
- Wire range 2 to 4 AWG CU

### Mechanical

- Panel mount
- 3 pole configuration
- Flammability, UL94 HB

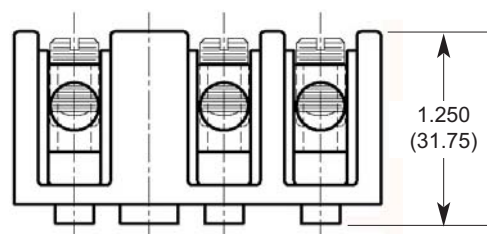
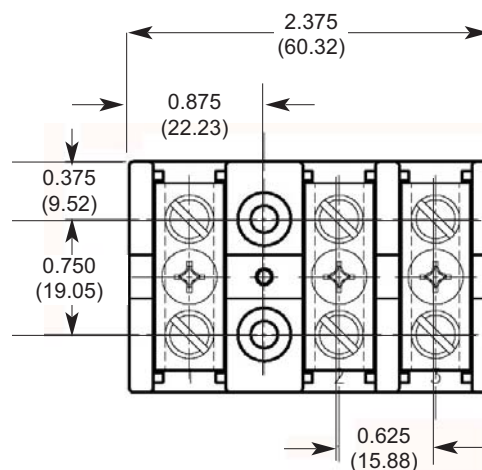



# Terminal Blocks With High Short-Circuit Current Ratings

## NDN63-WH-UL

### Agency/Standards

- UL 1059 Recognized, Guide XCFR2, File E62622
- General Industry Class per UL 1059, usage category C

### Electrical

- 600Vac or dc
- Short-Circuit Current Rating up to 100kA, See table page 16
- 65A ampacity
- Wire range 6 to 18 AWG CU

### Mechanical

- 35mm DIN rail and C-rail mount
- .375" (9.52) pole to pole spacing
- 3 pole configuration
- Marking tape MT12-½
- Flammability, UL94 V2

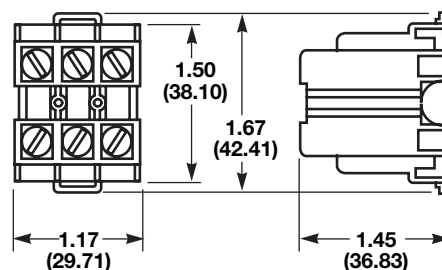

## TB300-03SP-UL

### Double Row Terminal Block

### Agency/Standards

- UL 1059 Recognized, Guide XCFR2, File E62622
- General Industry Class per UL 1059, usage category C

### Electrical

- 600Vac or dc
- Short-Circuit Current Rating up to 100kA, See table page 16
- 30A ampacity
- Wire range 10 to 18 AWG CU

### Mechanical

- Panel mount
- .562" (14.28) pole to pole spacing
- 3 pole configuration
- Flammability, UL94 V0

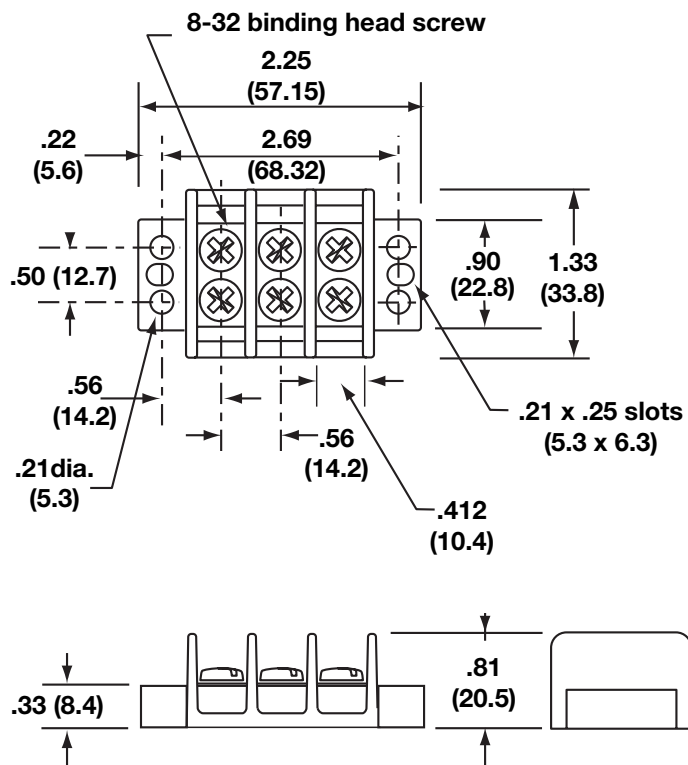

# Terminal Blocks With High Short-Circuit Current Ratings

## NDN111-WH-UL

### Agency/Standards

- UL 1059 Recognized, Guide XCFR2, File E62622
- General Industry Class per UL 1059, usage category C

### Electrical

- 600Vac or dc
- Short-Circuit Current Rating up to 100kA, See table page 16
- 90A ampacity
- Wire range 2 to 18 AWG CU

### Mechanical

- Panel mount
- 35mm DIN rail and C-rail mount
- .635" (16.13mm) pole to pole spacing
- 3 pole configuration
- Marking tape MT12-½
- Flammability, UL94 V2

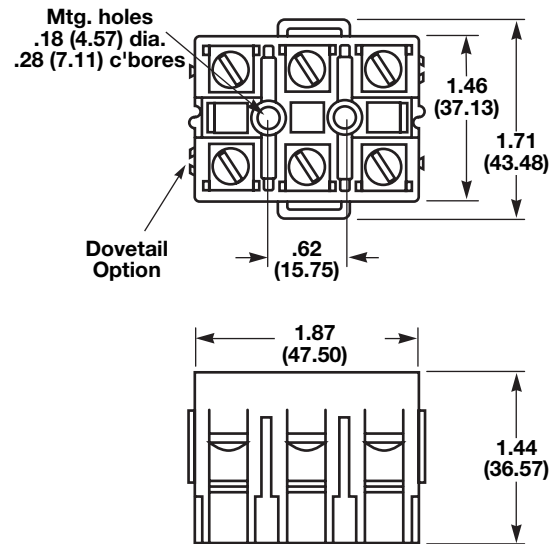

# Application Notes

## Proper Application

When applying Power Distribution Blocks (PDBs) and terminal blocks, there are several requirements that must be satisfied, based upon various UL Standards, the NEC®, and the specific application. Some of the requirements and ratings include: voltage, continuous current, wire range (load and line side), conductor terminal temperature rating, short-circuit current rating or withstand rating (SCCR), type and amp rating of upstream overcurrent protective device (fuse or circuit breaker) and spacing (between uninsulated live part and uninsulated grounded part or uninsulated live parts of opposite polarity). The requirements vary, based on the application for industrial control panels (feeder circuit or branch circuit), field applications, or HVAC applications.

New requirements in the 2005 NEC® for a marked short-circuit current rating (SCCR) on industrial control panels (NEC® 409.110), industrial machinery (NEC® 670.3A), and commercial/industrial HVAC equipment (NEC® 440.4(B)) have resulted in considerable attention being placed upon the proper selection and application of power distribution blocks and terminal blocks. In addition, UL508A Industrial Control Panels has a requirement that the assembly be marked with its short-circuit current rating. Per UL508A, each power circuit component in the panel, such as a PDB, has a SCCR expressed in amperes or kiloamperes and voltage. The SCCR shall be established by either being marked on the product, the instruction sheet provided with it, or from UL508A Supplement SB Table SB4.1. If an assembly short-circuit current rating above 10,000 amperes is desired, a power distribution block or a terminal block with a high short-circuit current rating must normally be utilized.

The following material includes some application notes on power distribution block and terminal block SCCR, UL Listed 1953 vs UL Recognized 1059, spacing requirements, conductor ampacities, conductor termination ratings affecting conductor ratings, and SCCR for multi-lug switches and circuit breakers.

## UL Listed 1953 vs. UL Recognized 1059

Listed products simply require checking to ensure that the product is used in accordance with its listing and labeling. However, for recognized products, such as terminal blocks, the “Conditions of Acceptability” must be investigated to ensure the product is suitable for the specific application, and then the procedure description must be documented in the manufacturer’s procedure for the assembly.

Most power distribution blocks available today are actually terminal blocks, and are recognized to UL 1059, the terminal block standard. Terminal blocks may or may not meet the spacing needed for OEM applications. Terminal blocks are marked with a UL recognition mark to ensure that the designer and UL inspector checks, among other things, that

there is adequate spacing for the OEM application in which they are being applied. Power distribution blocks are evaluated to UL1953, the power distribution block outline of investigation and are listed for general installation, which means they have adequate spacing for most OEM and field applications. These power distribution blocks are marked with a listing mark, which means that the inspector does not need to check “conditions of acceptability” as is needed with recognized products. As listed products, PDBs evaluated to UL1953 are suitable for use in the field. For example, an electrical contractor may install them in a metal wireway, something that may not be done with a recognized product such as a terminal block.

## Marking Equipment with SCCR

Marking the equipment with its short-circuit current rating (SCCR) is another important consideration in the proper application of PDBs and terminal blocks. This datasheet provides the details on Cooper Bussmann power distribution blocks and terminal blocks that have high short-circuit current ratings. Using these PDBs and terminal blocks with appropriate overcurrent protective devices makes it easier to achieve a high short-circuit current rating for the entire panel assembly.

## SCCR for Wire Management Products

There are different ways to determine the SCCR for wire management products (power distribution blocks, terminal blocks and multi-lug connectors) per UL508A Supplement SB: (1) Use tested and listed combinations, which consist of a specific part number and a specific type and maximum size overcurrent protective device. For instance, the power distribution blocks in this datasheet are all SCCR tested and listed combinations with fuses. An upstream current-limiting fuse of a specific class and maximum ampere rating as shown in the tables can be used to achieve the SCCR in the tables. Otherwise, the SCCR of the power distribution block will be determined by (2) or (3).

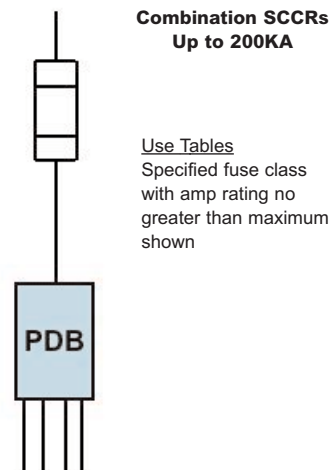

# Application Notes

- (2) UL508A has provisions to raise the rating of power distribution blocks by the use of current-limiting overcurrent protective devices such as current-limiting fuses (i.e. class J, T, RK1, etc.) in the feeder portion of the circuit.
- (3) If the SCCR rating for a power distribution block, terminal block or multi-lug connector is not established by (1) or (2) above, then the SCCR is the default 10kA per UL508A, Supplement SB, Table SB4.1.

For more in depth application material on SCCR see Industrial Control Panel section of publication SPD or Advanced Guide To Understanding Assembly Short-Circuit Current Rating.

### SCCR for Multi-Lug Connector (Power Distribution Lug) Switch and Circuit Breaker

Switches or circuit breakers with multi-lug connectors for conductor terminations serve a very similar wire management function as power distribution blocks. However, it cannot be assumed that when a multi-lug connector is installed on a circuit breaker or switch, that the SCCR of the multi-lug connector is the same as the interrupting rating of the protective device. Multi-lug connectors are covered under UL Standard 486 A/B. Much like a power distribution block, multi-lug connectors are components for distributing tap conductors to power loads and are not an integral part of the overcurrent protective device operation. Therefore, the multi-lug connector must be evaluated in a short-circuit test with the specific overcurrent protective device and listed with a specific combination SCCR. It is important to note, most switches and circuit breakers are not short-circuit tested with multi-lug connectors. If a multi-lug connector on a circuit breaker or switch does not have a combination SCCR with the specific overcurrent protective device used, then it is to be treated in the same manner as an unmarked power distribution block, which means the SCCR is the default 10kA (UL508A, Supplement SB). To repeat, unless the switch or circuit breaker with a multi-lug connector is specifically marked with a short-circuit current rating, the actual short-circuit current rating is 10,000 amperes (or less, if the interrupting rating of the circuit breaker or fuse is less than 10,000 amperes). The use of a listed and tested combination SCCR will ensure that a higher rating is achieved for the product and aid in achieving a higher overall SCCR for the industrial control panel.

### PDB Spacing Requirements for Equipment:

Depending upon the specific application and the standard to which the equipment is being designed, there are certain PDBs that can meet these spacing requirements, some with a high SCCR. The following details the spacing requirements at 600V based upon the equipment standards.

UL Standard	Spacing between live parts of opposite polarity		Spacing between live parts and grounded parts or enclosure @600V
	Through air @600V	Over surface @600V	
508A Feeder Circuits	1"	2"	1"
508A Branch Circuits	3/8"	1/2"	1/2"
1995 HVAC	3/8"	1/2"	1/2"

Note: Refer to Specific UL standards for complete spacing details.

### Industrial Control Panels (UL508A):

UL508A contains three important requirements to consider when applying power distribution blocks.

- Spacing of 1" through air, 2" over surface (301 to 600V) is required when used in a feeder circuit (that's everything ahead of or on the line side of the final branch circuit overcurrent protective device).
- An assumed short-circuit current rating of 10kA for power distribution and terminal blocks not marked with a higher short-circuit current rating, per UL508A Table SB4.1.
- Conductor ampacity requirements based on conductor terminal temperature ratings and UL508A conductor ampacities

The following details the requirements regarding the use of power distribution blocks in industrial control panels.

### Use of Power Distribution Blocks in Industrial Control Panel Feeder Circuits (600V & below)

- A Listed PDB (UL1953) can be used "as is" since it meets the 2" and 1" spacing requirements for feeder circuits in UL508A section 10.2 (see Table 10.2) & 28.2.4.
- A Recognized Terminal Block (UL1059) can only be used if it meets the spacing requirements in UL508A sections 10.2 (see Table 10.2) & 28.2.1 and it is suitable for field wiring (use Group A, C or D of UL 1059).
  - Use Group A: Service — including dead-front switch boards, panelboards, service equipment, and the like.
  - Use Group B: Commercial appliances, including business equipment, electronic data processing equipment, and the like.
  - Use Group C: Industrial, general.
  - Use Group D: Industrial, devices having limited ratings. Such as where the load on any single circuit of the terminal block does not exceed 15 amperes at 51 to 150 volts, 10 amperes at 151 to 300 volts, 5 amperes at 301 to 600 volts, or the maximum ampere rating, whichever is less.

**Listed PDBs have adequate spacing for feeder circuit applications but most recognized terminal blocks don't have the spacing required for use in feeder circuits**

# Application Notes

## Use of Power Distribution Blocks in Industrial Control Panel Branch Circuits (600V & below)

- A Listed PDB (UL1953) can be used “as is” since it exceeds the spacing requirements for branch circuits in UL508A section 10.2 (see table 10.1) & 28.2.4.
- A Recognized Terminal Block (UL1059) can only be used if it meets the spacing requirements at the required voltage in UL 508A, section 10.2 (see Table 10.1) & 28.2.1 and it is suitable for field wiring (Use Group A, C or D of UL 1059).

**Listed PDBs have adequate spacing for branch circuit applications and most recognized terminal blocks are also adequate for branch circuit applications**

## Power Distribution Block Application Examples – UL 508A

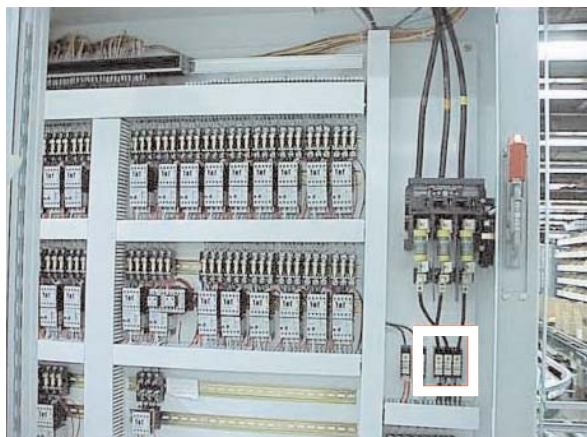

PDB in UL 508A, 480V Feeder Circuit must have spacing of 1” through air and 2” over surface. PDBs listed to UL 1953 meet these spacing requirements. Terminal Blocks recognized to UL 1059 must be verified to have required spacing.

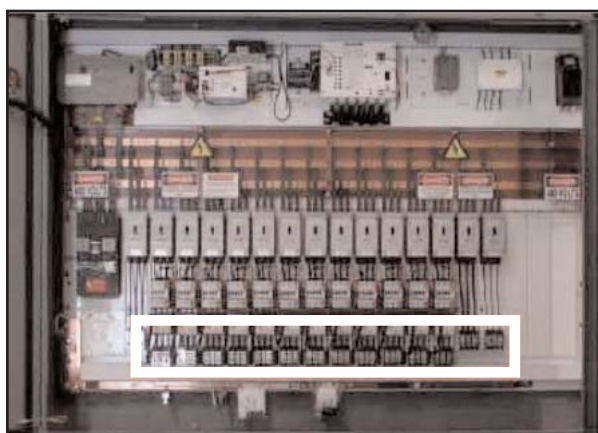

PDB in UL508A, 480V Branch Circuit must have spacing of 3/8” through air and 1/2” over surface. PDBs listed to UL 1953 meet these spacing as well as most terminal blocks recognized to UL 1059.

## Termination Ratings

Important considerations in the electrical and thermal relationship for components in a circuit are the conductor size, material, rated ampacity, conductor insulation temperature rating and the permissible connector device conductor temperature limits.

If a conductor terminates at two devices that have conductor terminations rated at two different temperatures, the conductor ampacity must correlate to the terminal with the lowest temperature rating.



Conductor size and insulation rating?

Conductors with higher temperature ratings can be used at their rated ampacities if the terminations of the circuit devices are rated for the higher temperature rated conductor [NEC 110.14(C)(1)(a)(3)]. However, the industry norm is that most devices rated 100A or less, such as blocks, disconnects, controllers and circuit breakers, have 60°C or 75°C rated terminations. For circuits greater than 100A, the norm is 75°C terminations. UL508A has further internal wiring restrictions requiring 90°C insulated conductors, but these conductors are sized based on either 60°C or 75°C allowable ampacities.

Terminations have a temperature rating that must be observed and this has implications on permissible conductor temperature rating and ampacity. Shown below are three common termination ratings and the rules. The conductor ampacity may also have to be derated due to ambient, conduit fill or other reasons.

Terminal Temp Rating	
60°C	60°C, 75°C, 90°C or higher temperature rated conductor can be used, but the ampacity of the conductor must be based as if conductor is rated 60°C.
75°C	75°C, 90°C or higher temperature rated conductor can be used, but the ampacity of the conductor must be based as if conductor is rated 75°C. A 60°C conductor is not permitted to be used.
60°C/75°C	Dual temperature rated termination. Either 60°C conductors at 60°C ampacity or 75°C conductors at 75°C ampacity can be used. If 90°C or higher temperature rated conductor is used, the ampacity of the conductor must be based as if conductor is rated 75°C.

# Application Notes

For more information on this see section Conductor & Terminations – Application Considerations in the Cooper Bussmann publication SPD – Selecting Protective Devices on [www.cooperbussmann.com](http://www.cooperbussmann.com)

**UL 508A Industrial Control Panels Conductors for Internal Wiring:** Copper conductors only. Conductors are sized based on either the 60°C or 75°C allowable conductor ampacities from UL508A, Table 28.1 (following). The 75°C ampacities can only be used if the termination temperature ratings at both ends of the conductor are rated 75°C or 60°C/75°C. In addition, the conductor insulation is required to be 90°C or higher temperature rated even though the ampacity is based on 60°C or 75°C (UL508A, 29.2.1 & 29.6.1(b)).

**UL508A, Table 28.1 (Partial)**

Wire size		60°C (140°F)	75°C (167°F)
AWG	(mm <sup>2</sup> )	Copper	Copper
14	(2.1)	15	15
12	(3.3)	20	20
10	(5.3)	30	30
8	(8.4)	40	50
6	(13.3)	55	65
4	(21.2)	70	85
3	(26.7)	85	100
2	(33.6)	95	115
1	(42.4)	110	130
1/0	(53.5)	–	150
2/0	(67.4)	–	175
3/0	(85.0)	–	200
4/0	(107.2)	–	230
250 kcmil	(127)	–	255
300	(152)	–	285
350	(177)	–	310
400	(203)	–	335
500	(253)	–	380
600	(304)	–	420
700	(355)	–	460
750	(380)	–	475
800	(405)	–	490
900	(456)	–	520
1000	(506)	–	545
1250	(633)	–	590
1500	(760)	–	625
1750	(887)	–	650
2000	(1013)	–	665

**NOTES**

1 For multiple-conductors of the same size (1/0 AWG or larger) at a terminal, the ampacity is equal to the value in this table for that conductor multiplied by the number of conductors that the terminal is able to accommodate.

**HVAC Equipment (UL1995):**

The electrical panel is required to be marked with the assembly SCCR per NEC® 440.4(B). The larger spacing that is mandated in UL508A is not present in UL1995. If the control panel for the HVAC equipment is a listed UL508A panel, then the larger UL508A spacing is required.

**Power Distribution Block Application UL 1995 Example**

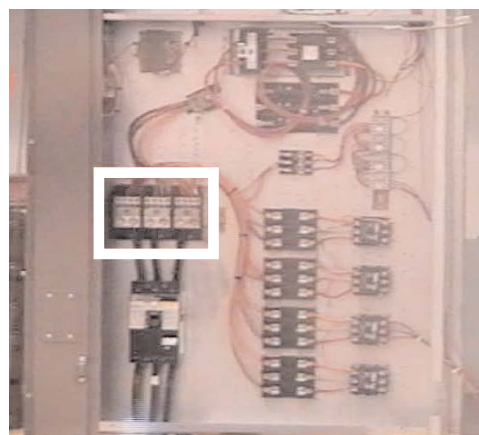

PDB in 480V UL 1995 HVAC Equipment must have spacing of 3/8" through air and 1/2" over surface. PDBs listed to UL 1953 meet this spacing as well as most terminal blocks recognized to UL 1059.

# Application Notes

## New 2005 NEC® Requirements For Wireways:

UL1953 listed power distribution blocks are suitable for the new 2005 NEC® requirement in section 376.56(B) for field installation in metal wireways, if they are the enclosed type (Series PDBFS) or open type with cover. UL1953 is explicit in paragraph 1.1 that these devices are used for splicing and tapping conductors in metallic wireways, junction boxes, auxiliary gutters, etc. Listed devices can be field installed; however, recognized devices are not intended for field installation. UL1059 devices are recognized and are terminal blocks, not power distribution blocks. Therefore UL1059 devices are not suitable for field installation and are not suitable for metal wireway applications even if enclosed or with covers. Also, the SCCR rating of a power distribution block installed in a metal wireway shall be equal to or greater than the available short-circuit current at the point of application (NEC® 110-10).

## National Electrical Code®:

376.56(B) Power Distribution Blocks.

- “(1) Installation. Power distribution blocks installed in metal wireways shall be listed.”
- “(4) Live Parts. Power distribution blocks shall not have exposed live parts in the wireway after installation.”

**When installed in metal wireways, the NEC® now requires a power distribution block that is listed (acceptable to AHJ). It must be an enclosed PDB or equipped with a cover to prevent exposure of live parts. Series PDBFS (enclosed style) and Series PDB with optional covers are UL1953 Power Distribution Blocks and are suitable for metal wireway applications. Terminal blocks, UL1059 recognized devices, are not suitable for this application.**

## Power Distribution Block Application Wireway Example

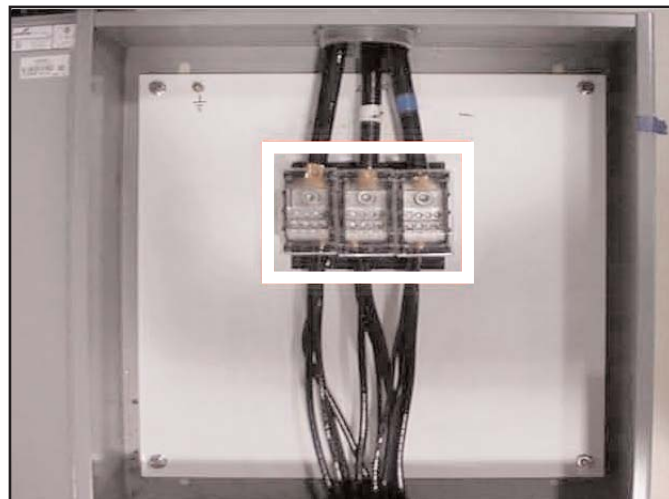

Series PDB (open style) with covers and Series PDBFS (enclosed style) are suitable for installation in metal wireways.