

XPT IGBT

$V_{CES} = 1200V$

$I_{C25} = 58A$

$V_{CE(sat)} = 1.8V$

Copack

Part number

IXA33IF1200HB

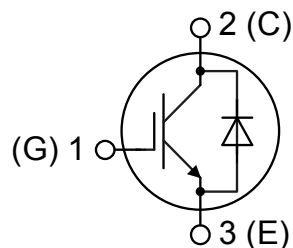

Backside: collector

**Features / Advantages:**

- Easy paralleling due to the positive temperature coefficient of the on-state voltage
- Rugged XPT design (Xtreme light Punch Through) results in:
 - short circuit rated for 10 μ sec.
 - very low gate charge
 - low EMI
 - square RBSOA @ 3x I_c
- Thin wafer technology combined with the XPT design results in a competitive low $V_{CE(sat)}$
- SONIC™ diode
 - fast and soft reverse recovery
 - low operating forward voltage

Applications:

- AC motor drives
- Solar inverter
- Medical equipment
- Uninterruptible power supply
- Air-conditioning systems
- Welding equipment
- Switched-mode and resonant-mode power supplies
- Inductive heating, cookers
- Pumps, Fans

Package: TO-247

- Industry standard outline
- RoHS compliant
- Epoxy meets UL 94V-0

IGBT				Ratings			
Symbol	Definition	Conditions	min.	typ.	max.	Unit	
V_{CES}	collector emitter voltage	$T_{VJ} = 25^{\circ}C$			1200	V	
V_{GES}	max. DC gate voltage				± 20	V	
V_{GEM}	max. transient gate emitter voltage				± 30	V	
I_{C25}	collector current	$T_C = 25^{\circ}C$			58	A	
I_{C80}		$T_C = 80^{\circ}C$			34	A	
P_{tot}	total power dissipation	$T_C = 25^{\circ}C$			250	W	
$V_{CE(sat)}$	collector emitter saturation voltage	$I_C = 25A; V_{GE} = 15V$		1.8	2.1	V	
				2.1		V	
$V_{GE(th)}$	gate emitter threshold voltage	$I_C = 1mA; V_{CE} = V_{CE}$	5.4	5.9	6.5	V	
I_{CES}	collector emitter leakage current	$V_{CE} = V_{CES}; V_{GE} = 0V$			0.1	mA	
				0.1		mA	
I_{GES}	gate emitter leakage current	$V_{GE} = \pm 20V$			500	nA	
$Q_{G(on)}$	total gate charge	$V_{CE} = 600V; V_{GE} = 15V; I_C = 25A$		76		nC	
$t_{d(on)}$	turn-on delay time	inductive load $V_{CE} = 600V; I_C = 25A$ $V_{GE} = \pm 15V; R_G = 39\Omega$	$T_{VJ} = 125^{\circ}C$	70		ns	
t_r	current rise time			40		ns	
$t_{d(off)}$	turn-off delay time			250		ns	
t_f	current fall time			100		ns	
E_{on}	turn-on energy per pulse			2.5		mJ	
E_{off}	turn-off energy per pulse			3		mJ	
RBSOA	reverse bias safe operating area	$V_{GE} = \pm 15V; R_G = 39\Omega$	$T_{VJ} = 125^{\circ}C$				
I_{CM}		$V_{CEmax} = 1200V$			75	A	
SCSOA	short circuit safe operating area	$V_{CEmax} = 900V$	$T_{VJ} = 125^{\circ}C$				
t_{sc}	short circuit duration	$V_{CE} = 900V; V_{GE} = \pm 15V$			10	μs	
I_{sc}	short circuit current	$R_G = 39\Omega; \text{non-repetitive}$		100		A	
R_{thJC}	thermal resistance junction to case				0.5	K/W	
R_{thCH}	thermal resistance case to heatsink			0.25		K/W	
Diode							
V_{RRM}	max. repetitive reverse voltage		$T_{VJ} = 25^{\circ}C$		1200	V	
I_{F25}	forward current		$T_C = 25^{\circ}C$		60	A	
I_{F80}			$T_C = 80^{\circ}C$		33	A	
V_F	forward voltage	$I_F = 30A$	$T_{VJ} = 25^{\circ}C$		2.20	V	
			$T_{VJ} = 125^{\circ}C$	1.95		V	
I_R	reverse current	$V_R = V_{RRM}$	$T_{VJ} = 25^{\circ}C$		*	mA	
	* not applicable, see Ices value above		$T_{VJ} = 125^{\circ}C$	*		mA	
Q_{rr}	reverse recovery charge	$V_R = 600V$ $-di_F/dt = -600A/\mu s$ $I_F = 30A; V_{GE} = 0V$	$T_{VJ} = 125^{\circ}C$	3.5		μC	
I_{RM}	max. reverse recovery current			30		A	
t_{rr}	reverse recovery time			350		ns	
E_{rec}	reverse recovery energy			0.9		mJ	
R_{thJC}	thermal resistance junction to case				0.7	K/W	
R_{thCH}	thermal resistance case to heatsink			0.25		K/W	

Package TO-247			Ratings			
Symbol	Definition	Conditions	min.	typ.	max.	Unit
I_{RMS}	RMS current	per terminal			70	A
T_{VJ}	virtual junction temperature		-40		150	°C
T_{op}	operation temperature		-40		125	°C
T_{stg}	storage temperature		-40		150	°C
Weight				6		g
M_D	mounting torque		0.8		1.2	Nm
F_C	mounting force with clip		20		120	N

Product Marking

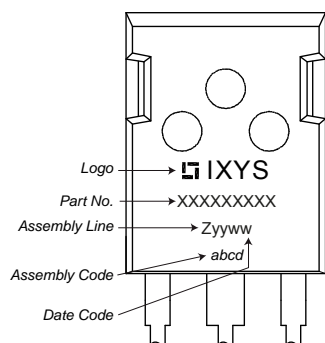

Part number

- I = IGBT
- X = XPT IGBT
- A = Gen 1 / std
- 33 = Current Rating [A]
- IF = Copack
- 1200 = Reverse Voltage [V]
- HB = TO-247AD (3)

Ordering	Part Number	Marking on Product	Delivery Mode	Quantity	Code No.
Standard	IXA33IF1200HB	IXA33IF1200HB	Tube	30	508562

Equivalent Circuits for Simulation

* on die level

$T_{VJ} = 150\text{ °C}$

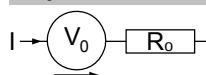

$V_{0\max}$ threshold voltage

$R_{0\max}$ slope resistance *

	IGBT	Diode	
$V_{0\max}$	1.1	1.25	V
$R_{0\max}$	55	28.3	mΩ

Outlines TO-247

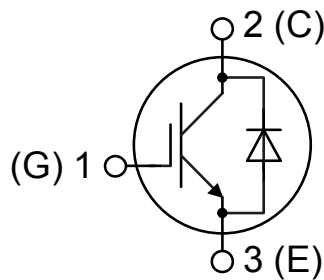
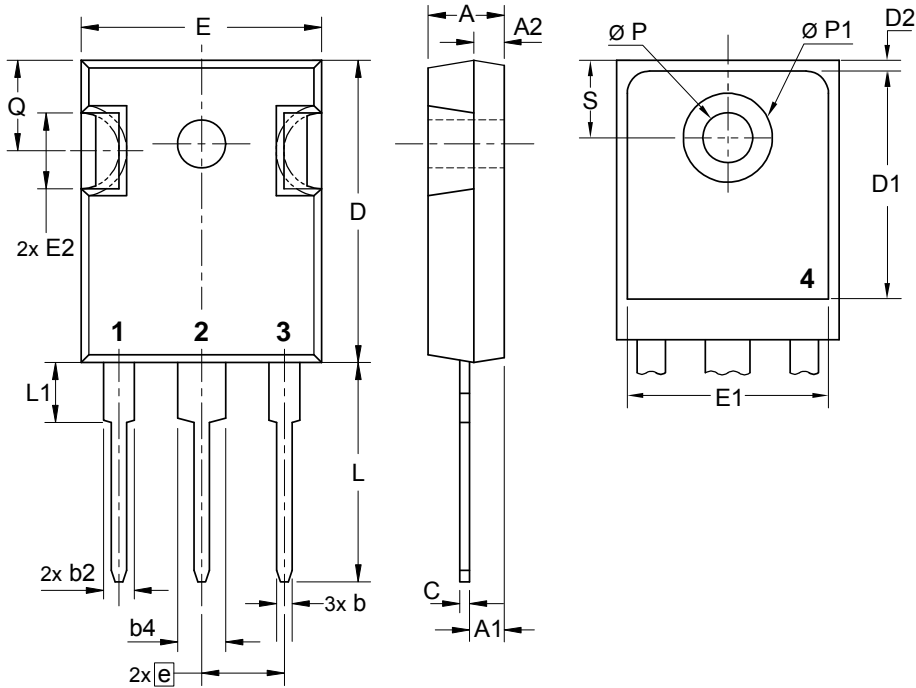

IGBT

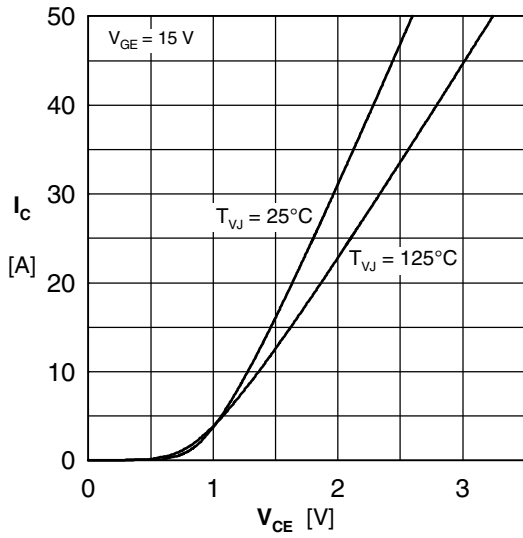

Fig. 1 Typ. output characteristics

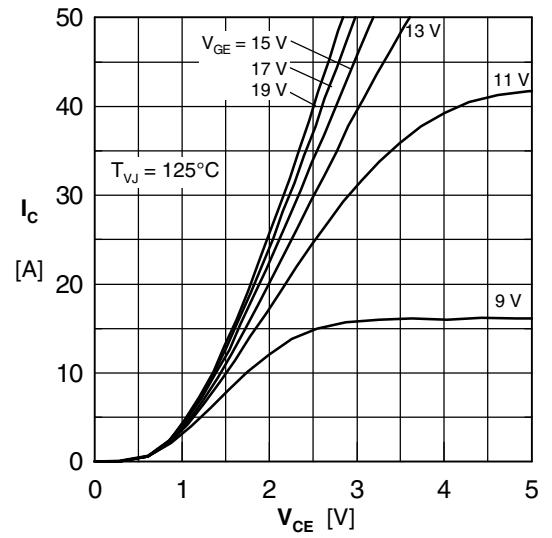

Fig. 2 Typ. output characteristics

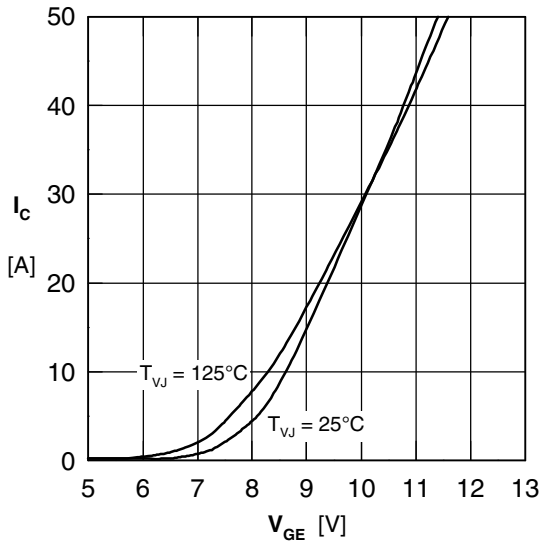

Fig. 3 Typ. transfer characteristics

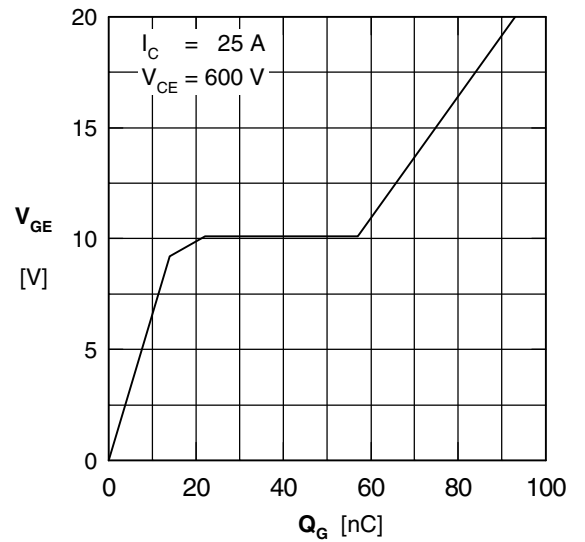

Fig. 4 Typ. turn-on gate charge

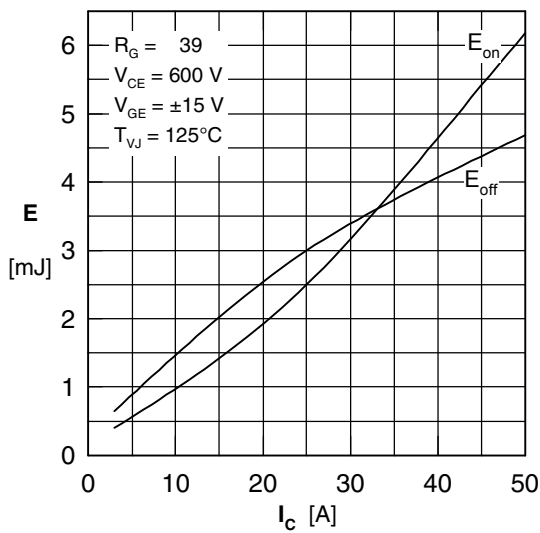

Fig. 5 Typ. switching energy vs. collector current

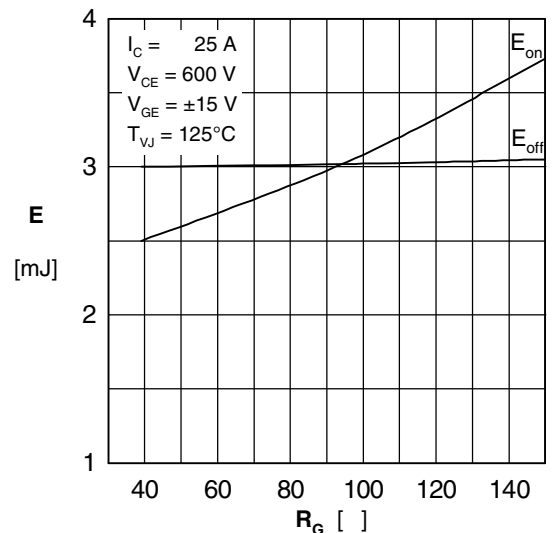

Fig. 6 Typ. switching energy vs. gate resistance

Diode

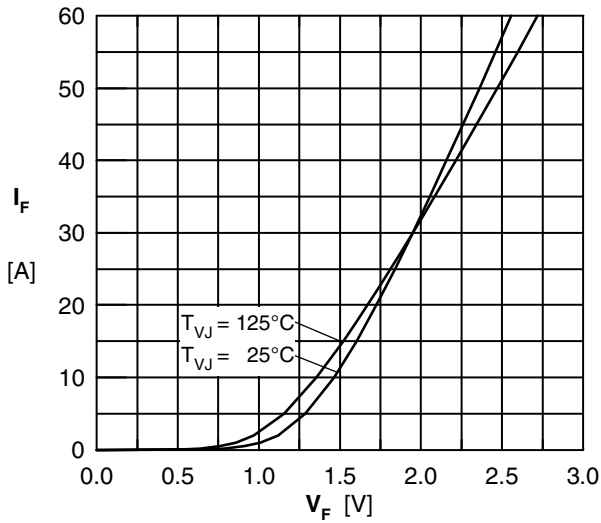

Fig. 7 Typ. Forward current versus V_F

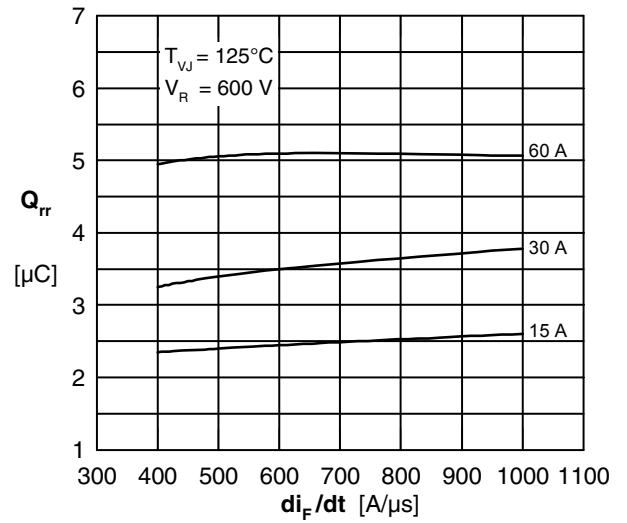

Fig. 8 Typ. reverse recov.charge Q_{rr} vs. di/dt

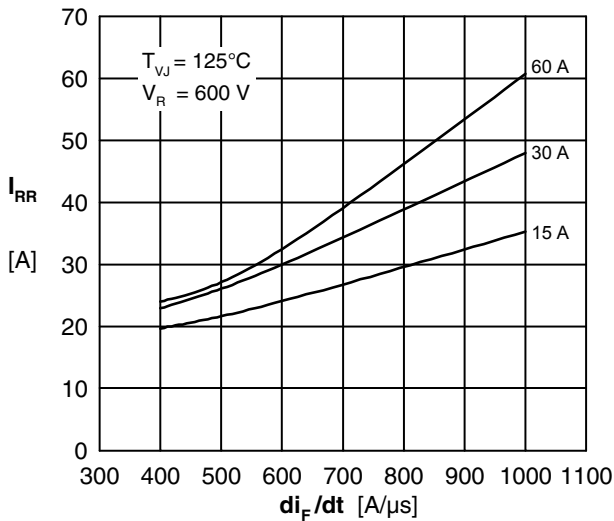

Fig. 9 Typ. peak reverse current I_{RM} vs. di/dt

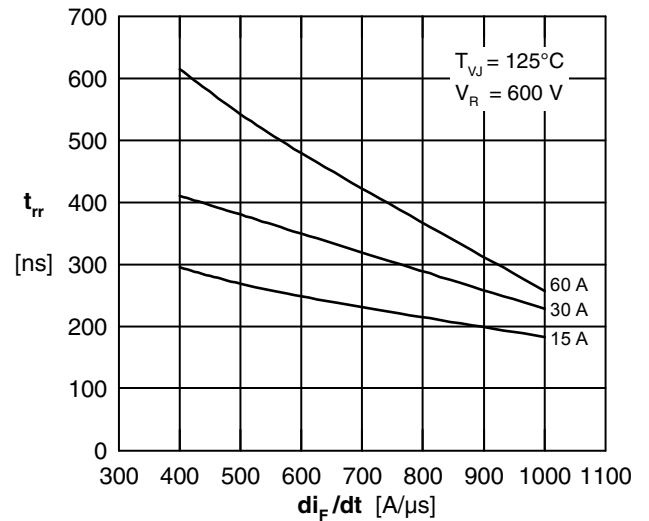

Fig. 10 Typ. recovery time t_{rr} versus di/dt

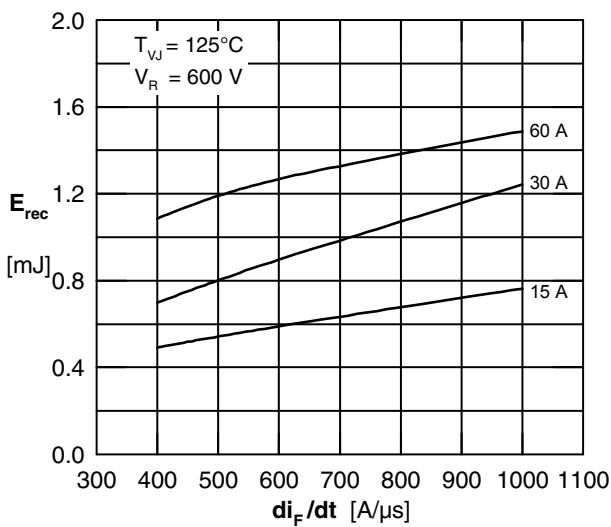

Fig. 11 Typ. recovery energy E_{rec} versus di/dt

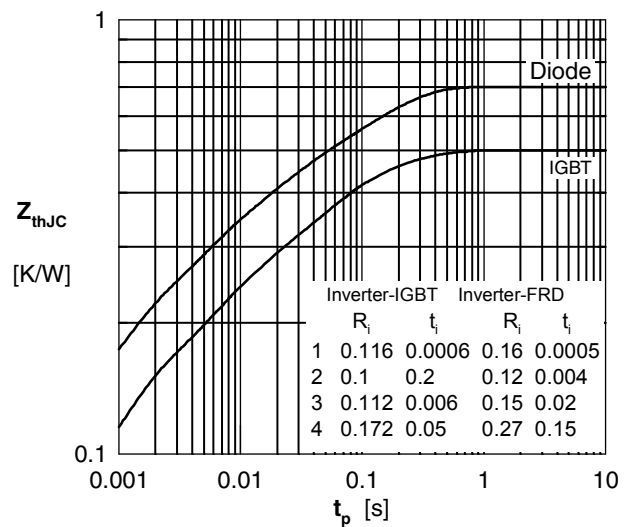

Fig. 12 Typ. transient thermal impedance