

**Trench™**  
**Power MOSFETs**

**IXTH110N25T**  
**IXTV110N25TS**

$V_{DSS} = 250V$   
 $I_{D25} = 110A$   
 $R_{DS(on)} \leq 24m\Omega$

N-Channel Enhancement Mode  
Avalanche Rated  
Fast Intrinsic Rectifier

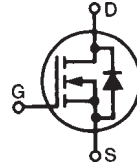

Symbol	Test Conditions	Maximum Ratings	
$V_{DSS}$	$T_J = 25^\circ C$ to $150^\circ C$	250	V
$V_{DGR}$	$T_J = 25^\circ C$ to $150^\circ C$ , $R_{GS} = 1M\Omega$	250	V
$V_{GSS}$	Continuous	$\pm 20$	V
$V_{GSM}$	Transient	$\pm 30$	V
$I_{D25}$	$T_C = 25^\circ C$	110	A
$I_{L(RMS)}$	External Lead Current Limit	75	A
$I_{DM}$	$T_C = 25^\circ C$ , Pulse Width Limited by $T_{JM}$	300	A
$I_A$	$T_C = 25^\circ C$	25	A
$E_{AS}$	$T_C = 25^\circ C$	1	J
$P_D$	$T_C = 25^\circ C$	694	W
$dv/dt$	$I_S \leq I_{DM}$ , $V_{DD} \leq V_{DSS}$ , $T_J \leq 150^\circ C$	10	V/ns
$T_J$		-55 to +150	$^\circ C$
$T_{JM}$		+150	$^\circ C$
$T_{stg}$		-55 to +150	$^\circ C$
$T_L$	1.6mm (0.063in) from Case for 10s	300	$^\circ C$
$T_{SOLD}$	Plastic Body for 10s	260	$^\circ C$
$M_d$	Mounting Torque (to-247)	1.13/10	Nm/lb.in.
$F_c$	Mounting force (PLUS220SMD)	11..65/2.5..14.6	N/lb.
<b>Weight</b>	TO-247	6	g
	PLUS220SMD	4	g

TO-247 (IXTH)

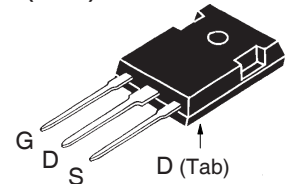

PLUS220SMD(IXTV\_S)

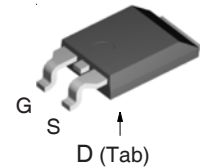

G = Gate      D = Drain  
S = Source    Tab = Drain

**Features**

- International Standard Packages
- Avalanche Rated
- High Current Handling Capability
- Fast Intrinsic Rectifier
- Low  $R_{DS(on)}$

**Advantages**

- Easy to Mount
- Space Savings
- High Power Density

**Applications**

- DC-DC Converters
- Battery Chargers
- Switch-Mode and Resonant-Mode Power Supplies
- DC Choppers
- AC Motor Drives
- Uninterruptible Power Supplies

Symbol	Test Conditions ( $T_J = 25^\circ C$ , Unless Otherwise Specified)	Characteristic Values		
		Min.	Typ.	Max.
$BV_{DSS}$	$V_{GS} = 0V$ , $I_D = 250\mu A$	250		V
$V_{GS(th)}$	$V_{DS} = V_{GS}$ , $I_D = 1mA$	3.0		5.0 V
$I_{GSS}$	$V_{GS} = \pm 20V$ , $V_{DS} = 0V$			$\pm 200$ nA
$I_{DSS}$	$V_{DS} = V_{DSS}$ , $V_{GS} = 0V$ $T_J = 125^\circ C$			5 $\mu A$ 250 $\mu A$
$R_{DS(on)}$	$V_{GS} = 10V$ , $I_D = 0.5 \cdot I_{D25}$ , Notes 1, 2			24 m $\Omega$

Symbol	Test Conditions ( $T_J = 25^\circ\text{C}$ , Unless Otherwise Specified)	Characteristic Values		
		Min.	Typ.	Max.
$g_{fs}$	$V_{DS} = 10\text{V}$ , $I_D = 0.5 \cdot I_{D25}$ , Note 1	65	110	S
$C_{iss}$	$V_{GS} = 0\text{V}$ , $V_{DS} = 25\text{V}$ , $f = 1\text{MHz}$		9400	pF
$C_{oss}$			850	pF
$C_{rss}$			55	pF
$t_{d(on)}$	<b>Resistive Switching Times</b> $V_{GS} = 15\text{V}$ , $V_{DS} = 0.5 \cdot V_{DSS}$ , $I_D = 0.5 \cdot I_{D25}$ $R_G = 2\Omega$ (External)		19	ns
$t_r$			27	ns
$t_{d(off)}$			60	ns
$t_f$			27	ns
$Q_{g(on)}$		$V_{GS} = 10\text{V}$ , $V_{DS} = 0.5 \cdot V_{DSS}$ , $I_D = 25\text{A}$		157
$Q_{gs}$			40	nC
$Q_{gd}$			50	nC
$R_{thJC}$			0.18	$^\circ\text{C/W}$
$R_{thCS}$		0.25		$^\circ\text{C/W}$

### Source-Drain Diode

Symbol	Test Conditions ( $T_J = 25^\circ\text{C}$ , Unless Otherwise Specified)	Characteristic Values		
		Min.	Typ.	Max.
$I_S$	$V_{GS} = 0\text{V}$			110 A
$I_{SM}$	Repetitive, Pulse Width Limited by $T_{JM}$			350 A
$V_{SD}$	$I_F = 55\text{A}$ , $V_{GS} = 0\text{V}$ , Note 1			1.2 V
$t_{rr}$	$I_F = 55\text{A}$ , $-di/dt = 250\text{A}/\mu\text{s}$ , $V_R = 100\text{V}$ , $V_{GS} = 0\text{V}$		170	ns
$I_{RM}$			27	A
$Q_{RM}$			2.3	$\mu\text{C}$

### Notes:

1. Pulse test,  $t \leq 300\mu\text{s}$ , duty cycle,  $d \leq 2\%$ .
2. On through-hole package,  $R_{DS(ON)}$  kelvin test contact location must be 5mm or less from the package body.

### TO-247 Outline

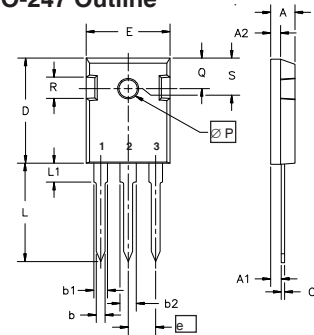

Terminals: 1 - Gate 2 - Drain  
3 - Source

Dim.	Millimeter		Inches	
	Min.	Max.	Min.	Max.
A	4.7	5.3	.185	.209
A <sub>1</sub>	2.2	2.54	.087	.102
A <sub>2</sub>	2.2	2.6	.059	.098
b	1.0	1.4	.040	.055
b <sub>1</sub>	1.65	2.13	.065	.084
b <sub>2</sub>	2.87	3.12	.113	.123
C	.4	.8	.016	.031
D	20.80	21.46	.819	.845
E	15.75	16.26	.610	.640
e	5.20	5.72	0.205	0.225
L	19.81	20.32	.780	.800
L1		4.50		.177
∅P	3.55	3.65	.140	.144
Q	5.89	6.40	0.232	0.252
R	4.32	5.49	.170	.216
S	6.15	BSC	242	BSC

### PLUS220SMD Outline

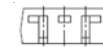
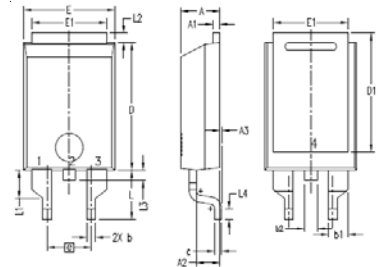

Terminals: 1 - Gate 2,4 - Drain  
3 - Source

SYM	INCHES		MILLIMETER	
	MIN	MAX	MIN	MAX
A	.169	.185	4.30	4.70
A1	.028	.035	0.70	0.90
A2	.098	.118	2.50	3.00
A3	.000	.010	0.00	0.25
b	.035	.047	0.90	1.20
b1	.080	.095	2.03	2.41
b2	.054	.064	1.37	1.63
c	.028	.035	0.70	0.90
D	.551	.591	14.00	15.00
D1	.512	.539	13.00	13.70
E	.394	.433	10.00	11.00
E1	.331	.346	8.40	8.80
e		.200BSC	5.08	BSC
L	.209	.228	5.30	5.80
L1	.118	.138	3.00	3.50
L2	.035	.051	0.90	1.30
L3	.047	.059	1.20	1.50
L4	.039	.059	1.00	1.50

IXYS Reserves the Right to Change Limits, Test Conditions, and Dimensions.

IXYS MOSFETs and IGBTs are covered by one or more of the following U.S. patents:	4,835,592	4,931,844	5,049,961	5,237,481	6,162,665	6,404,065 B1	6,683,344	6,727,585	7,005,734 B2	7,157,338B2
	4,860,072	5,017,508	5,063,307	5,381,025	6,259,123 B1	6,534,343	6,710,405 B2	6,759,692	7,063,975 B2	
	4,881,106	5,034,796	5,187,117	5,486,715	6,306,728 B1	6,583,505	6,710,463	6,771,478 B2	7,071,537	

Fig. 1. Output Characteristics @  $T_J = 25^\circ\text{C}$

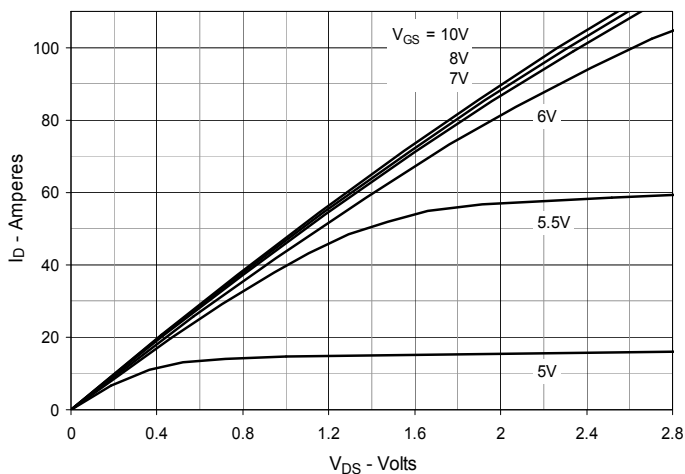

Fig. 2. Extended Output Characteristics @  $T_J = 25^\circ\text{C}$

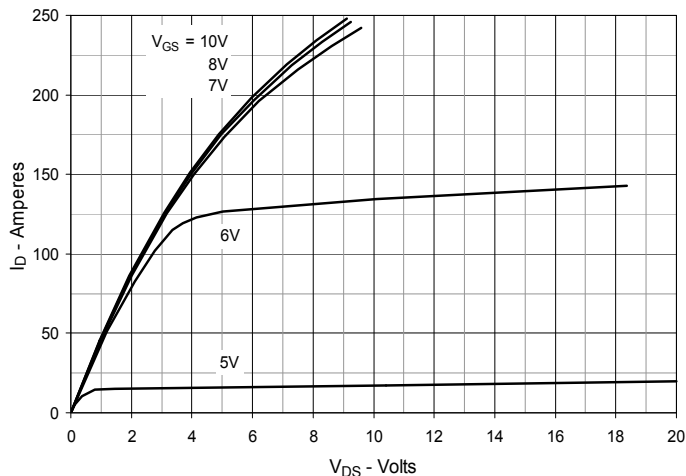

Fig. 3. Output Characteristics @  $T_J = 125^\circ\text{C}$

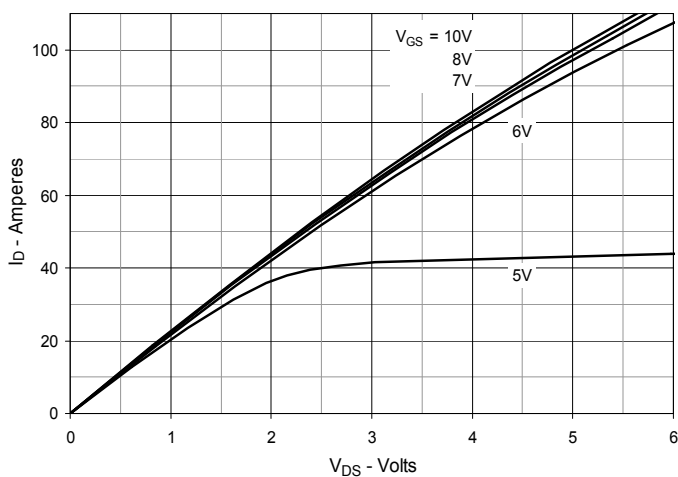

Fig. 4.  $R_{DS(on)}$  Normalized to  $I_D = 55\text{A}$  Value vs. Junction Temperature

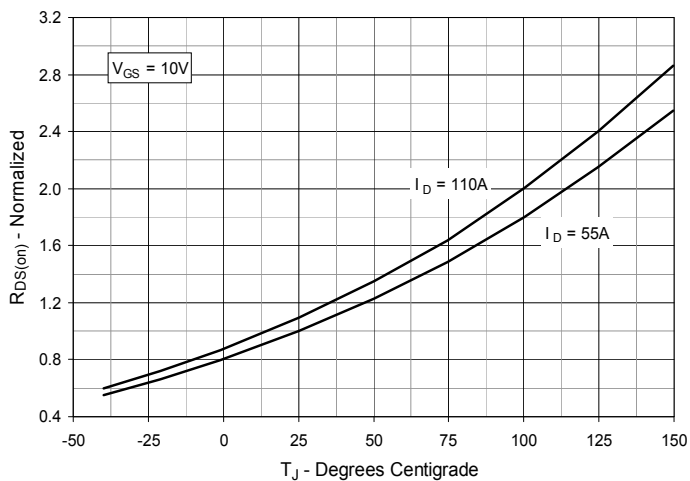

Fig. 5.  $R_{DS(on)}$  Normalized to  $I_D = 55\text{A}$  Value vs. Drain Current

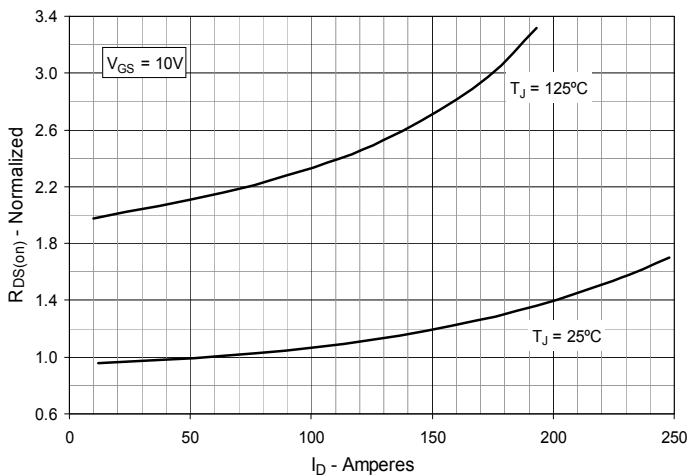

Fig. 6. Maximum Drain Current vs. Case Temperature

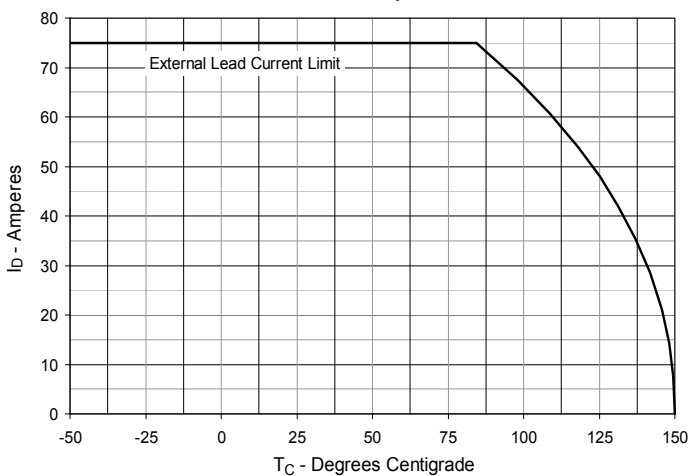

Fig. 7. Input Admittance

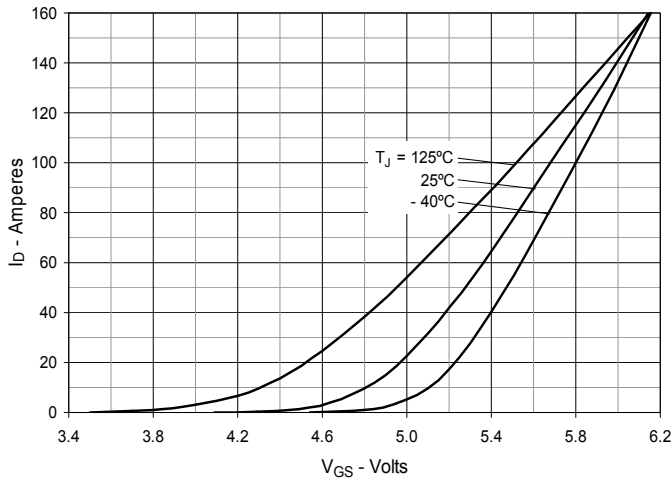

Fig. 8. Transconductance

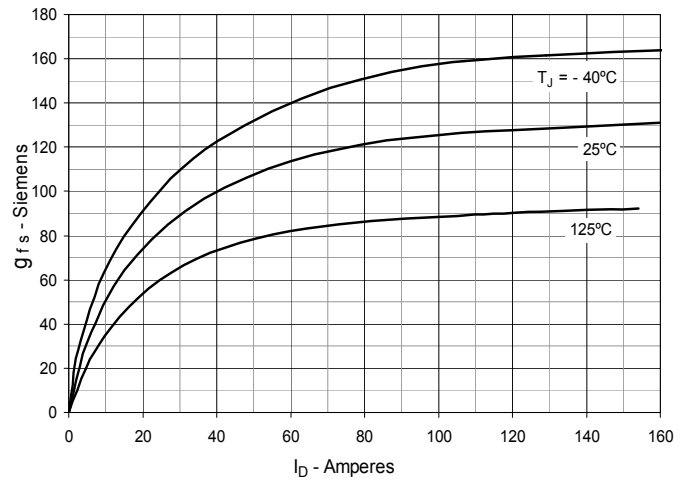

Fig. 9. Forward Voltage Drop of Intrinsic Diode

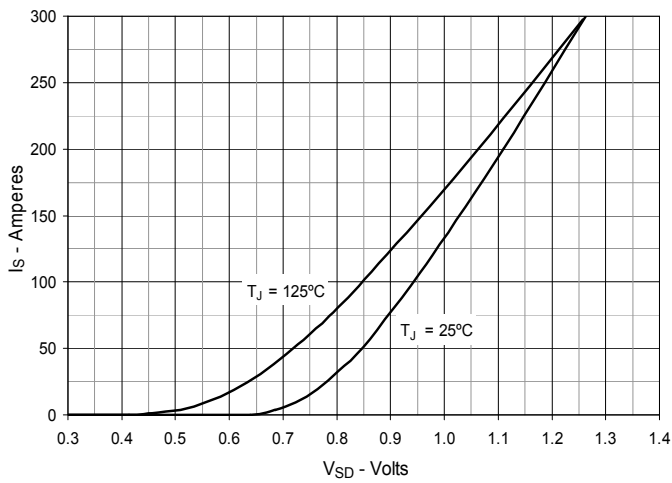

Fig. 10. Gate Charge

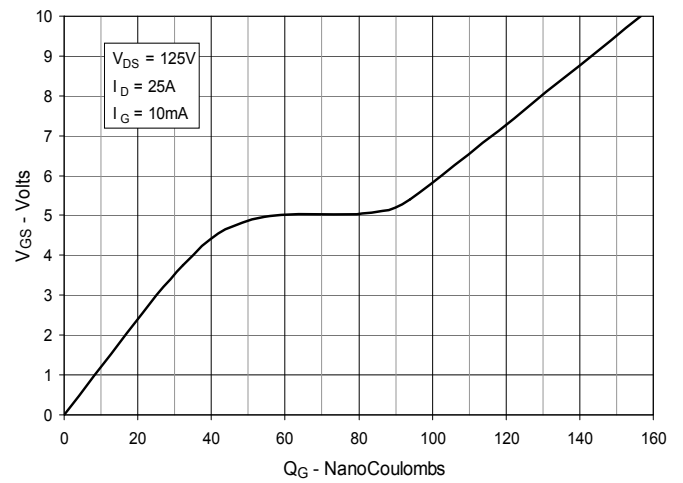

Fig. 11. Capacitance

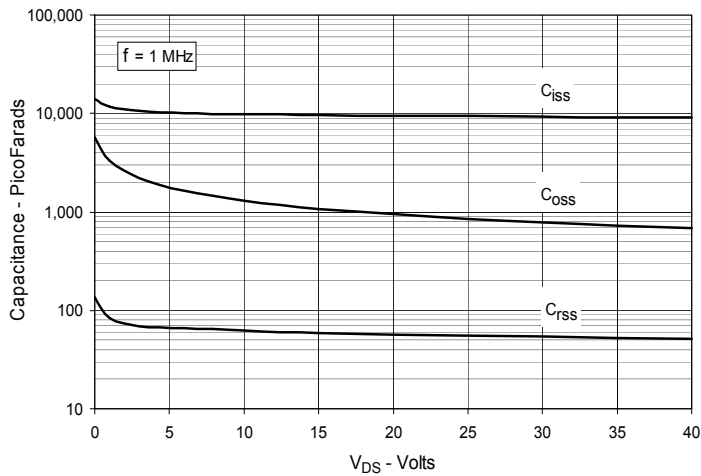
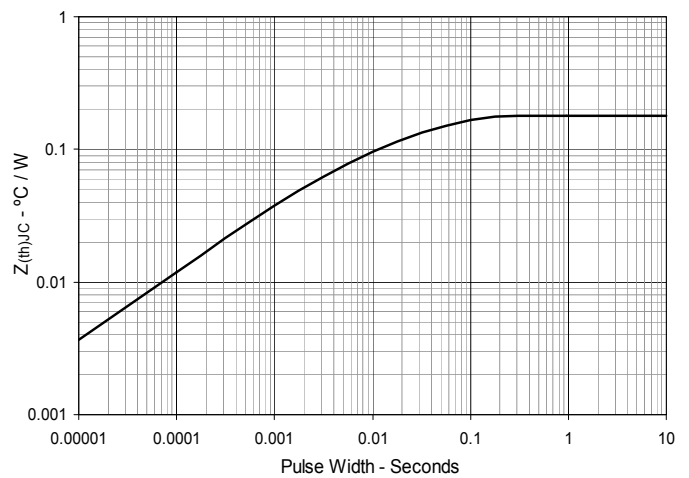
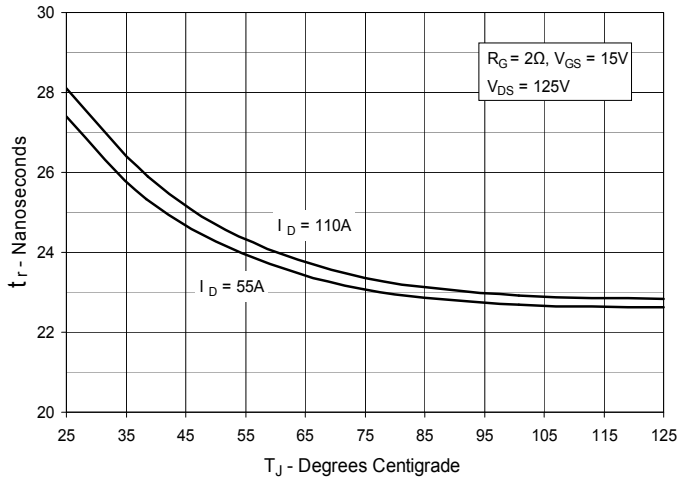

Fig. 12. Maximum Transient Thermal Impedance



**Fig. 13. Resistive Turn-on**  
**Rise Time vs. Junction Temperature**



**Fig. 14. Resistive Turn-on**  
**Rise Time vs. Drain Current**

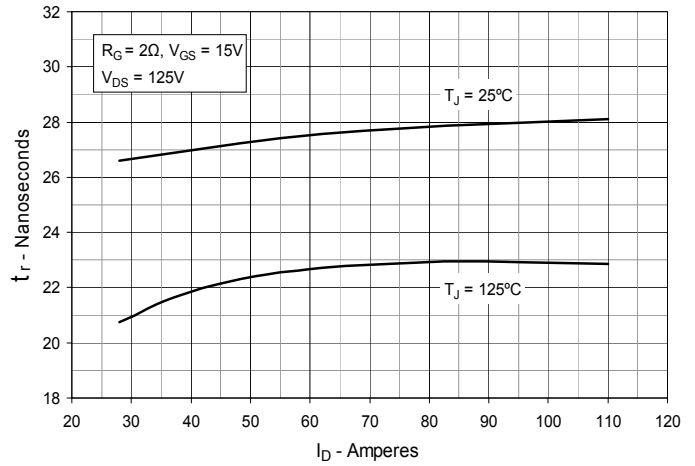

**Fig. 15. Resistive Turn-on**  
**Switching Times vs. Gate Resistance**

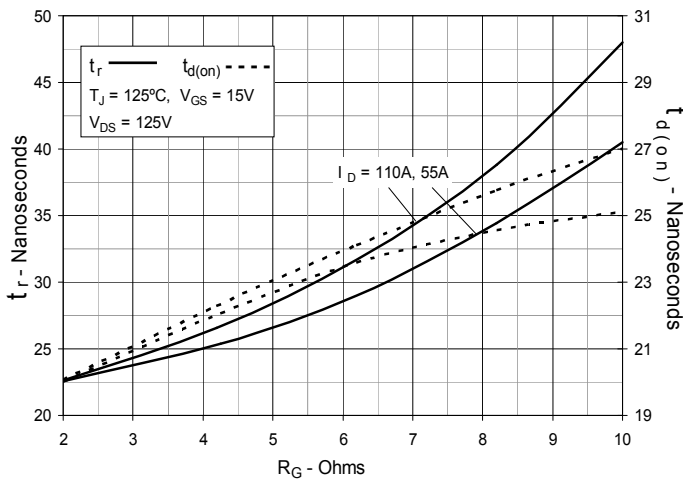

**Fig. 16. Resistive Turn-off**  
**Switching Times vs. Junction Temperature**

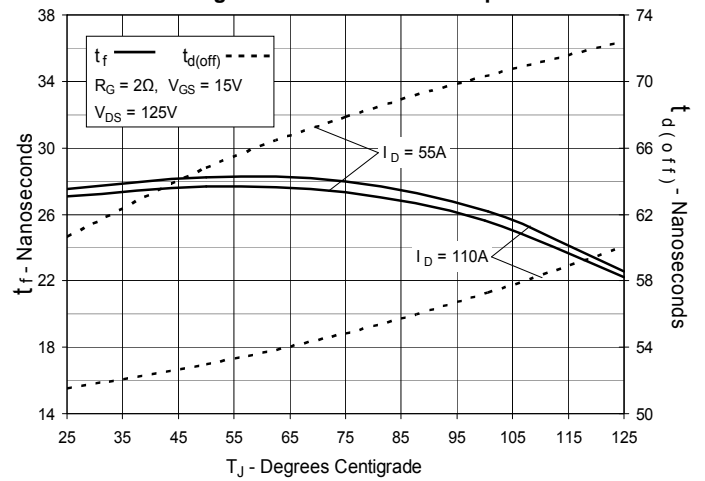

**Fig. 17. Resistive Turn-off**  
**Switching Times vs. Drain Current**

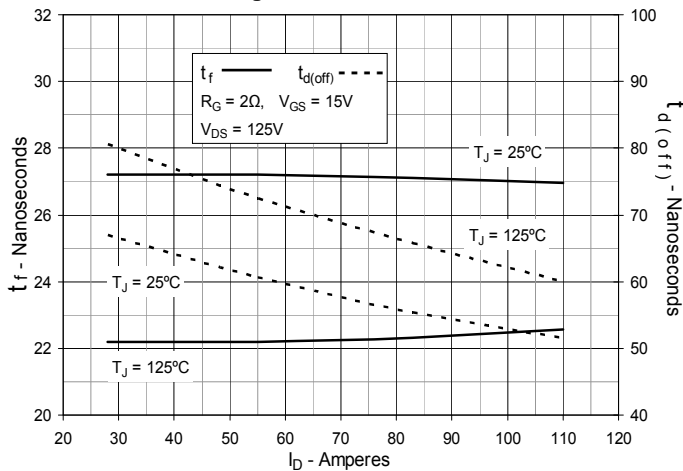

**Fig. 18. Resistive Turn-off**  
**Switching Times vs. Gate Resistance**

