

REV.	ECN. NO.	APPD.
A	HC97010	T. K. LIU for 1/3/97
B	HC97129	C. CHEN 01-21-97
C	HC971904	ERIC YU 9/4/97
D	HC9856	T. K. LIU 4/10

- NOTE: UNLESS OTHERWISE SPECIFIED
 1. DIMENSION SHALL BE INTERPRETED PER ANSI
 Y14.5M-1982
 2. ALL DIMENSIONS ARE IN MILLIMETERS WITH INCH
 EQUIVALENT SHOWN IN BRACKET.
 3. PRODUCTION SPECIFICATION PER DWG NO.
 307-0300-141.
 4. MATERIALS OF \varnothing AND \odot ARE SHOWN ON
 DRAWING 307-0000-818-7
 Δ HL1620*- \square
 SEE DWG. NO. 307-0000-297

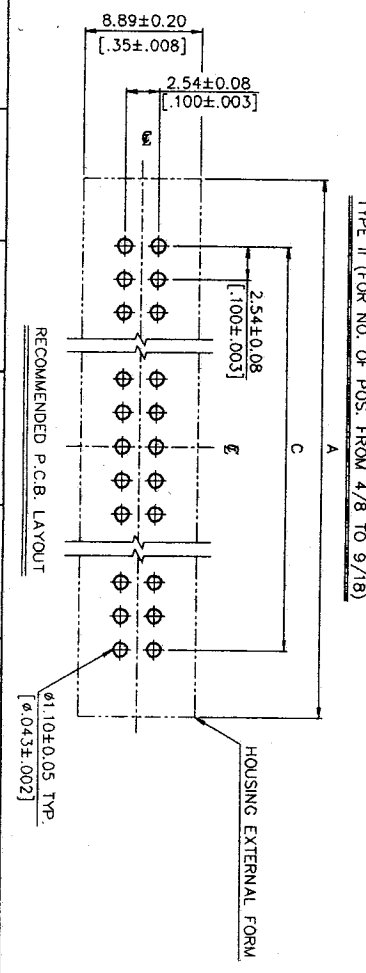
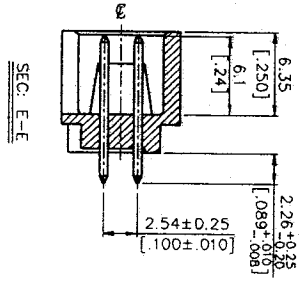
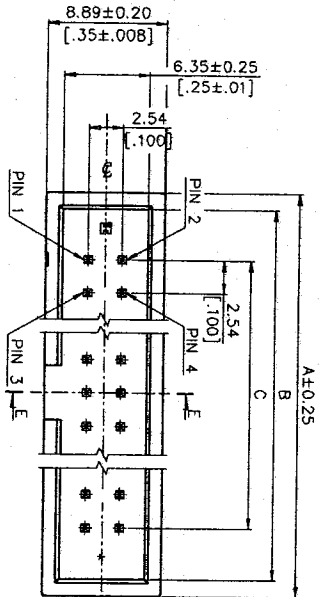
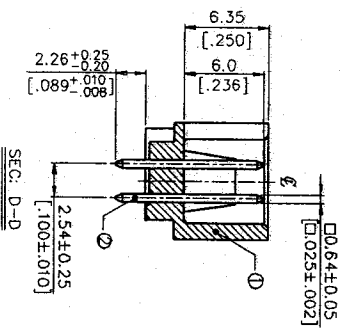
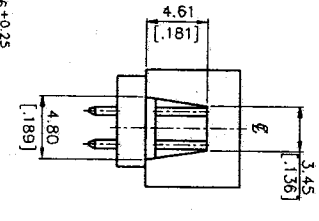
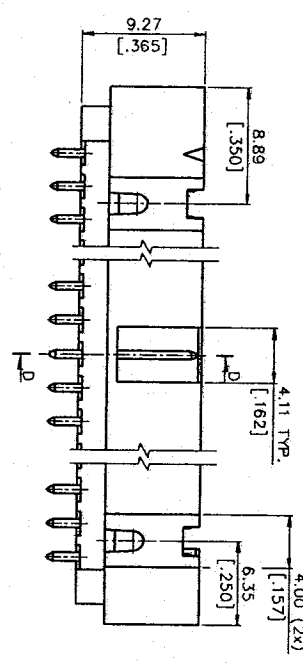
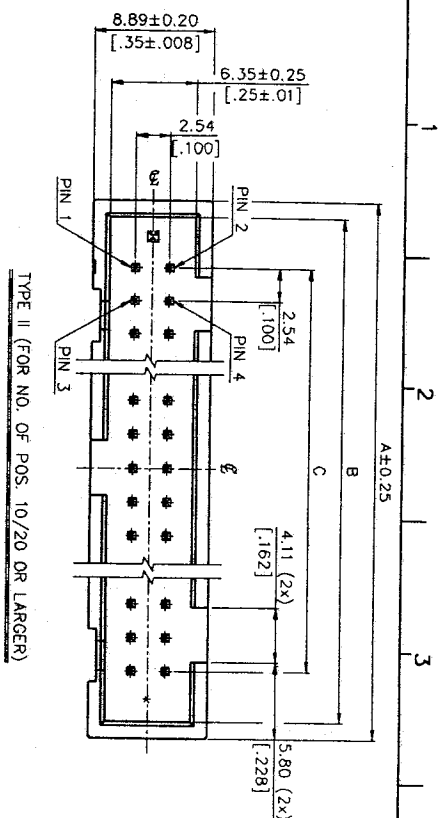

PART NO.	NO. OF POS.	DIM. A	DIM. B	DIM. C	STYLE
HL1625*- \square	25/50	71.12 [2.800]	68.58 [2.700]	80.96 [2.400]	TYPE I
HL1620*- \square	20/40	58.42 [2.300]	55.88 [2.200]	48.26 [1.900]	TYPE I
HL1617*- \square	17/34	50.80 [2.000]	48.28 [1.900]	40.64 [1.600]	TYPE I
HL1615*- \square	15/30	45.72 [1.800]	43.18 [1.700]	35.56 [1.400]	TYPE I
HL1612*- \square	12/24	38.10 [1.500]	35.56 [1.400]	27.94 [1.100]	TYPE I
HL1610*- \square	10/20	33.02 [1.300]	30.48 [1.200]	22.86 [900]	TYPE I
HL1605*- \square	5/10	20.32 [800]	17.78 [700]	10.16 [400]	TYPE I

FOXCONN
 HON HAI PRECISION IND. CO., LTD.
 TAIPEI, TAIWAN, R.O.C.

FYCN900003

NAME (INTENDED USE):
 HEADER CONN.

PART NO. (INTENDED USE):
 HL16 SERIES

APPD: I. K. LIU 1/3/97
 CHKD: PAI DEC/31/96
 DR: Y. S. HSIAO 12/31/96

DWG NO.: 307-0000-289

SCALE: SHEET 1/1
 REV. D

THESE DRAWINGS AND SPECIFICATIONS ARE THE PROPERTY OF HON HAI PRECISION IND. CO., LTD. AND SHALL NOT BE REPRODUCED OR USED IN ANY MANNER WITHOUT THE PRIOR WRITTEN CONSENT OF HON HAI PRECISION IND. CO., LTD.

1 2 3 4 5 6 7

ITEM	DESCRIPTION	Q' TY	MATERIAL	TREATMENT	REMARK
1	HOUSING	1	THERMOPLASTIC, UL94V-0 RATED	MOLDED COLOR SEE DRAWING NO. 307-0000-297	
2	CONTACT	SAME AS NO. OF POSITION. (SEE BELOW)	COPPER ALLOY	50u" MIN. NICKEL UNDER PLATING, 100u" MIN. TIN/LEAD PLATING ON TAILS, CONTACT AREA PLATING SEE BELOW.	

REMARK:

1. PROD. NO.: H L 1 6 -

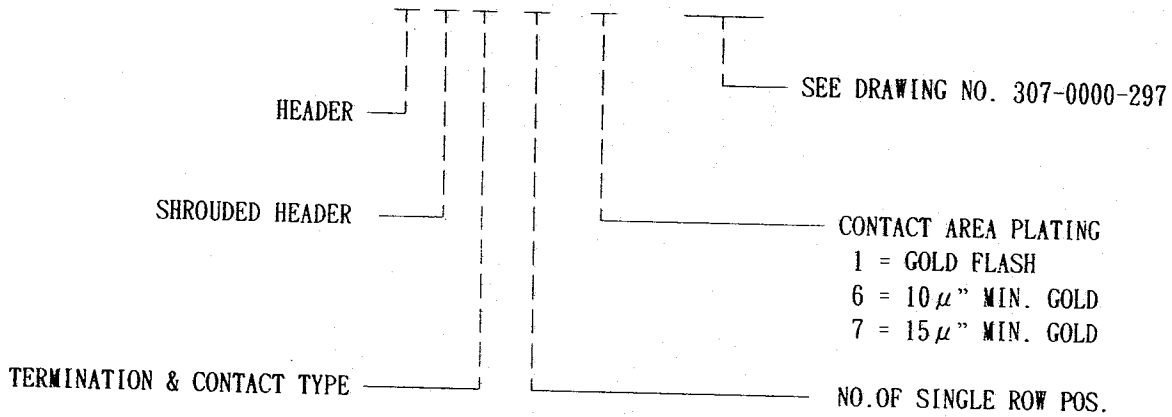

FOXCONN		HON HAI PRECISION INDUSTRY CO., LTD.	
		TAIPEI TAIWAN R.O.C.	
TITLE: 4 WALL, .100" CENTER		APP.: I. K. LIU for 1/3'97	
HEADER CONN. (S/T)		CHKD: PAI DEC/31'96	
PROD. NO.: HL16 SERIES		DR. : Y. S. HSIAO 12/31'96	
DWG. NO. 307-0000-817		REV. : C	SHEET: 1 OF 1

C	HC98760	I.K. LIU
B	HC97262	I. K. LIU for 2/17'97
A	HC97010	I. K. LIU for 1/3'97
REV.	ECN. NO.	APPD.

H L(S) NN NN N - (XX) XN

(1)

REV.	ECN. NO.	APPD.
A	HC97734	I. K. LIU 2/25'97
B	HC97491	I. K. LIU 3/31'97
C	HC971719	I. K. LIU 8/14'97
D	HC98569	I. K. LIU 3/7'98
E	HC98886	DICK Lee 4/10'98
F	HC981840	DICK Lee 7/14'98
G	HC983061	DICK Lee 11/30'98
H	HC990456	<i>Dick Lee</i> 7/8/98

CODE	DESCRIPTION
NONE	STANDARD PRODUCT
D0	1st PIN IS REMOVE
D2	20th PIN IS REMOVE
D3	21st PIN IS REMOVE
D4	8th PIN IS REMOVE
D6	25th PIN IS REMOVE
D7	26th PIN IS REMOVE
D9	15th PIN IS REMOVE
E3	30th PIN IS REMOVE
E4	38th PIN IS REMOVE
P1	6th PIN IS REMOVE
P4	5th PIN IS REMOVE
P5	10th PIN IS REMOVE
P6	2nd PIN IS REMOVE
P7	3rd PIN IS REMOVE
P8	17th PIN IS REMOVE
P9	9th PIN IS REMOVE
L3	32nd PIN IS REMOVE
L5	18th PIN IS REMOVE
L6	14th PIN IS REMOVE
L7	16th PIN IS REMOVE
L9	25th PIN IS REMOVE
T9	25th,27th & 28th PINS ARE REMOVE
U1	3rd & 5th PINS ARE REMOVE

REMARK:

- (1) NONE: STANDARD PRODUCT (COLOR BLACK)
- K: THE FIRST & LAST PAIRS OF TERMINALS ARE DEFORMED WITH KINKS
- W: HOUSING COLOR IVORY
- KW: THE FIRST & LAST PAIRS OF TERMINALS ARE DEFORMED WITH KINKS, HOUSING COLOR IVORY.
- K3: THE FIRST & LAST PAIRS OF TERMINALS ARE DEFORMED WITH KINKS (SPECIAL MODIFICATION CODE)

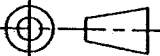
X.±	X°.±	UNITS	NAME(INTENDED USE)	FOXCONN HON HAI PRECISION IND. CO.,LTD. TAIPEI, TAIWAN, R.O.C.						
.X±	.X°.±	MAT'L	HEADER CONN.							
.XX±	.XX°.±	FINISH	PART NO.(INTENDED USE)	TITLE:						
.XXX±	.XXX°.±		HL SERIES	CUSTOMER DRAWING						
THESE DRAWINGS AND SPECIFICATIONS ARE THE PROPERTY OF HON HAI PRECISION IND. CO., LTD. AND SHALL NOT BE REPRODUCED COPIED OR USED IN ANY MANNER WITHOUT THE PRIOR WRITTEN CONSENT OF HON HAI PRECISION IND. CO., LTD.			APPD: I. K. LIU 2/25'97	DWG NO.:						
			Q'TY	CHKD: PAI Feb/24'97	307-0000-297					
			DR: Y. S. HSIAO 2/24'97	 <table border="1"> <thead> <tr> <th>SCALE</th> <th>SHEET</th> <th>REV.</th> </tr> </thead> <tbody> <tr> <td>N/A</td> <td>1/1</td> <td>H</td> </tr> </tbody> </table>	SCALE	SHEET	REV.	N/A	1/1	H
SCALE	SHEET	REV.								
N/A	1/1	H								

1

2

3

4