

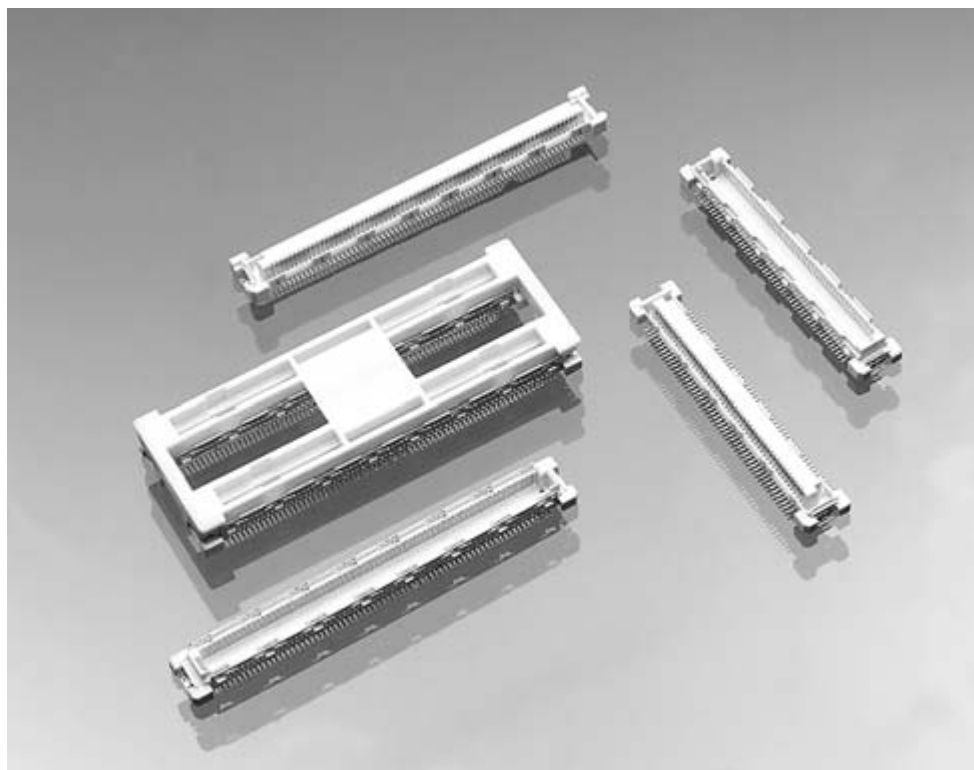

**0.6mm Free Height (FH) and GIGA Connectors**

**Product Facts**

- 0.6 [.024] pitch SMT connectors for parallel board stacking
- Connector sizes ranging from 50 to 280 positions
- Solder pegs included for anti-peeling
- Available packaged on "tape-and-reel" for automatic placement per EIA standards
- Surface areas provided to accommodate vacuum nozzles
- Enhanced electrical performance grounded version (GIGA) available for high speed signals
- Recognized under the Component Program of Underwriter Laboratories Inc.,  File No. E28476



Tyco Electronics 0.6mm Free Height (FH) and GIGA connectors are designed for use in the parallel stacking of printed circuit boards. These 0.6 [.024] fine pitch connectors provide the capability of varying the spacing between parallel boards, depending upon the components to be packaged or equipment designs. They are best suited for applications where miniaturization is essential, such as notebook PCs, sub-notebook PCs, pen pads, cellular phones and communication equipment.

This connector family consists of vertical board-mount receptacles and plug assemblies. By using various combinations of plug and receptacle heights, it is possible to alter the spacing of parallel boards between 4 [.157] and 16 [.630].

The enhanced electrical performance version (GIGA) includes receptacles loaded with contacts for grounding circuits at every 9 or 10 signal circuits. These ground contacts mate with grounding plates on both sides of the plug assemblies.

0.6mm FH and GIGA connectors are packaged in trays or on "tape-and-reel" for high volume production. Each connector half features surface areas to accommodate "pick-and-place" vacuum nozzles without secondary covers. Some connector sizes are available packaged in a unique "bridge" to facilitate the aligning of dual connectors on PC boards during placement and SMT processing.

**Performance Characteristics**

- Voltage Rating** — 50 VAC
- Current Rating** — 0.5 ampere
- Overall Resistance** — less than 30 milliohms
- Dielectric Withstanding Voltage** — 0.2 kVAC
- Operating Temperature** — -40°C to +85°C

0.6mm Free Height (FH) and GIGA Connectors

**Board-to-Board Stacking Height Selection Guide (By Receptacle/Plug Combinations)**

Plugs	Receptacles		
	4H	8H	12H
4H	<p>Pages 30, 34</p> <p>Receptacle Plug 4.0 [.157]</p> <p>Pages 32, 33 &amp; 35</p>	N/A	<p>Page 31</p> <p>Receptacle Plug 12.0 [.472]</p> <p>Pages 32, 33 &amp; 35</p>
5H	<p>Page 30</p> <p>Receptacle Plug 5.0 [.197]</p> <p>Pages 32, 33</p>	N/A	N/A
6H	<p>Pages 30, 34</p> <p>Receptacle Plug 6.0 [.236]</p> <p>Pages 32, 33 &amp; 35</p>	<p>Page 31</p> <p>Receptacle Plug 10.0 [.394]</p> <p>Page 33</p>	<p>Page 31</p> <p>Receptacle Plug 14.0 [.551]</p> <p>Pages 32, 33 &amp; 35</p>
7H	<p>Page 30</p> <p>Receptacle Plug 7.0 [.276]</p> <p>Page 33</p>	<p>Page 31</p> <p>Receptacle Plug 11.0 [.433]</p> <p>Page 33</p>	<p>Page 31</p> <p>Receptacle Plug 15.0 [.591]</p> <p>Page 33</p>
8H	<p>Pages 30, 34</p> <p>Receptacle Plug 8.0 [.315]</p> <p>Pages 32, 33 &amp; 35</p>	N/A	<p>Page 31</p> <p>Receptacle Plug 16.0 [.630]</p> <p>Pages 32, 33 &amp; 35</p>

0.6mm Free Height (FH) and GIGA Connectors

**0.6mm Free Height (FH) and GIGA Connectors (Continued)**

**Plug/Receptacle Mating  
Cross-Sections**

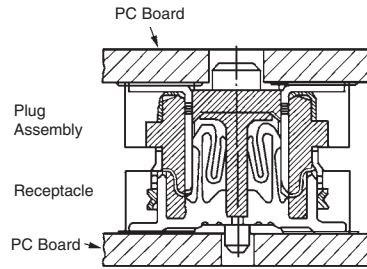

Cross-Section of Grounding Position

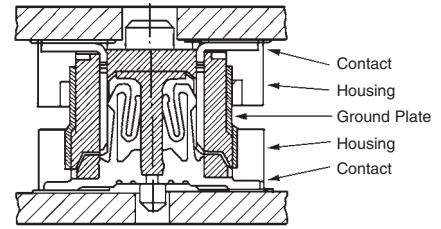

Cross-Section of Signal Position

**Typical Example of 4H Receptacle with Common Ground Contacts and 4H GIGA Plug with Ground Plates**

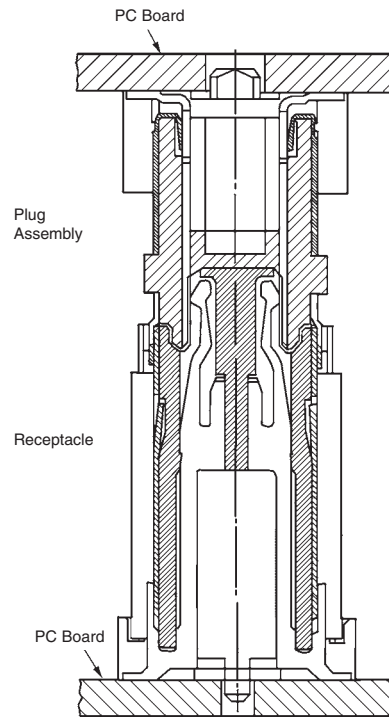

Cross-Section of Grounding Position

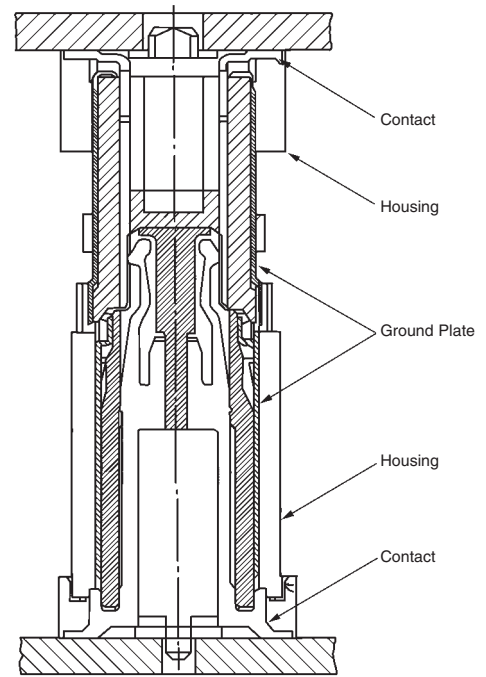

Cross-Section of Signal Position

**Typical Example of 8H and 12H Receptacle and Plug;  
both with Ground Plates**

0.6mm Free Height (FH) and GIGA Connectors

**0.6mm Free Height Receptacles, 0.6 [.024] Pitch**

**4H (4mm)**

**Note:** All receptacles include common ground contacts that mate with standard plug assemblies or GIGA plug assemblies with ground plates.

**Material and Finish**

**Housing** — High temperature thermoplastic, 94V-0 rated

**Signal Contacts** — Copper alloy; duplex plated 0.00020 [.000008] min. gold on contact area, 0.00005 [.000002] min. gold on solder area, with entire contact underplated 0.00130 [.000051] min. nickel

**Ground Contacts** — Copper alloy; duplex plated 0.00020 [.000008] min. gold on contact area, 0.00100 [.000039] min. tin on solder area, with entire contact underplated 0.00130 [.000051] min. nickel

**Related Product Data**

**Performance Characteristics** — page 27

**Stacking Height Combinations** — page 28

**Mating Plugs** — pages 32, 33 & 35

**PC Board Layout** — pages 36 & 37

**Technical Documents** (page 113)

**Product Specification**  
108-5468

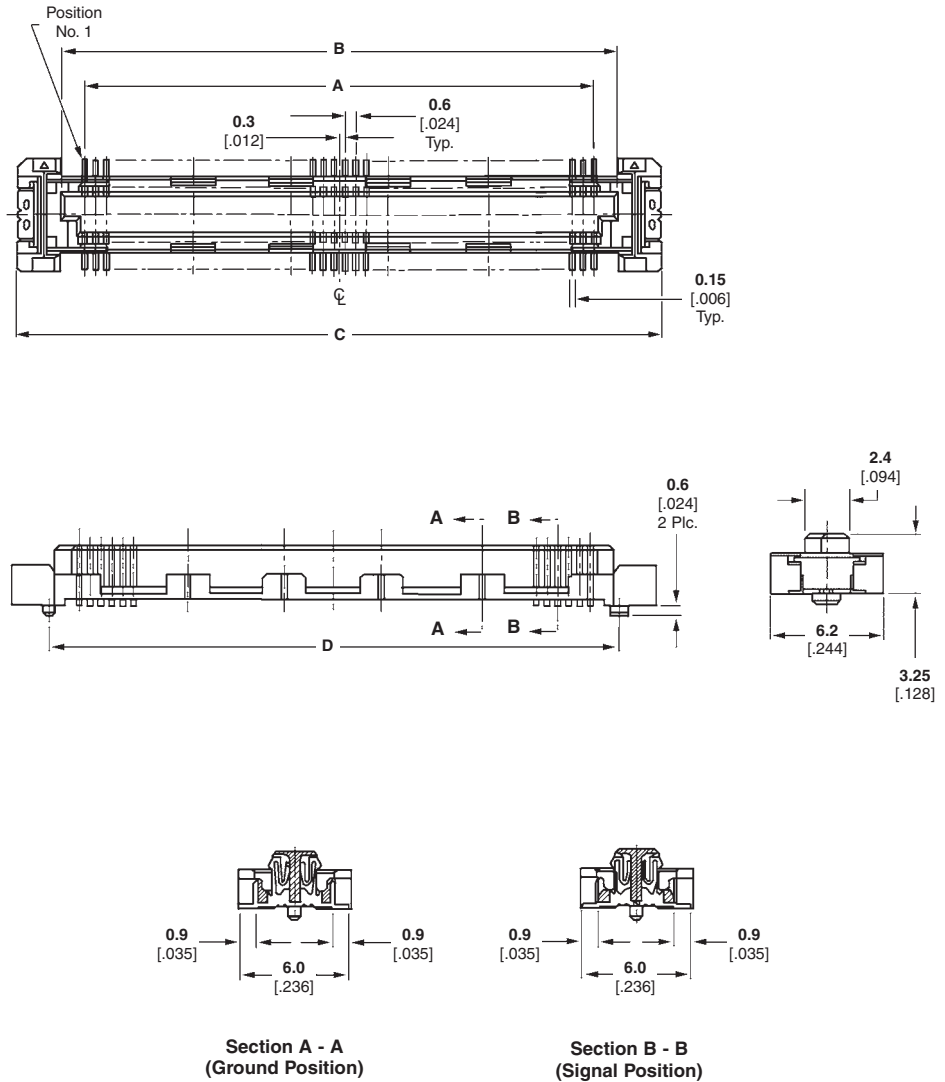

Stacking Height	No. of Positions	Dimensions				Part Numbers	
		A	B	C	D	Tray Packaged	Tape Packaged
4H	50	14.4 .567	17.0 .669	21.7 .854	17.6 .693	5316077-3	5353190-3
	70	20.4 .803	23.0 .906	27.7 1.091	23.6 .929	—	5-5353190-5
	80	23.4 .921	26.0 1.024	30.7 2.087	26.6 1.047	5316560-6	5353190-6
	100	29.4 1.158	32.0 1.260	36.7 1.445	32.6 1.284	—	5353190-8
	140	41.4 1.630	44.0 1.732	48.7 1.917	44.6 1.756	1-5316077-0	1-5353190-0
	160	47.4 1.866	50.0 1.969	54.7 2.154	50.6 1.992	1-5316560-1	—

**Note:** Free Height (FH) receptacles for 8H (8mm) and 12H (12mm) stacking height are shown on page 31. Part Numbers are RoHS compliant.

0.6mm Free Height (FH) and GIGA Connectors

**0.6mm Free Height Receptacles, 0.6 [ .024 ] Pitch** (Continued)

**8H (8mm) and 12H (12mm)**

**Note:** All receptacles include common ground contacts that mate with standard plug assemblies or GIGA plug assemblies with ground plates.

**Material and Finish**

**Housing** — High temperature thermoplastic, 94V-0 rated

**Signal Contacts** — Copper alloy; duplex plated 0.00020 [ .000008 ] min. gold on contact area, 0.00005 [ .000002 ] min. gold on solder area, with entire contact underplated 0.00130 [ .000051 ] min. nickel

**Ground Contacts** — Copper alloy; duplex plated 0.00020 [ .000008 ] min. gold on contact area, 0.00100 [ .000039 ] min. tin on solder area, with entire contact underplated 0.00130 [ .000051 ] min. nickel

**Related Product Data**

**Performance Characteristics** — page 27

**Stacking Height Combinations** — page 28

**Mating Plugs** — pages 32 & 33

**PC Board Layout** — pages 36 & 37

**Technical Documents** (page 113)

**Product Specification**  
108-5468

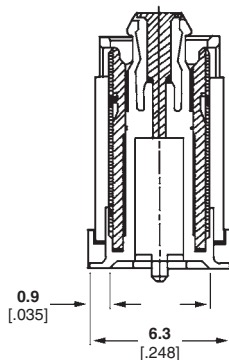
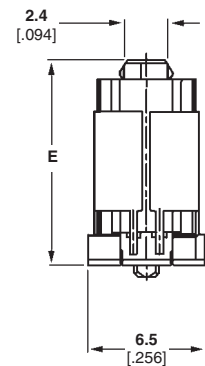
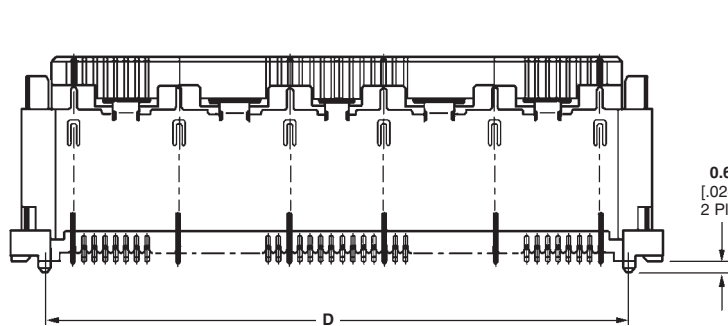
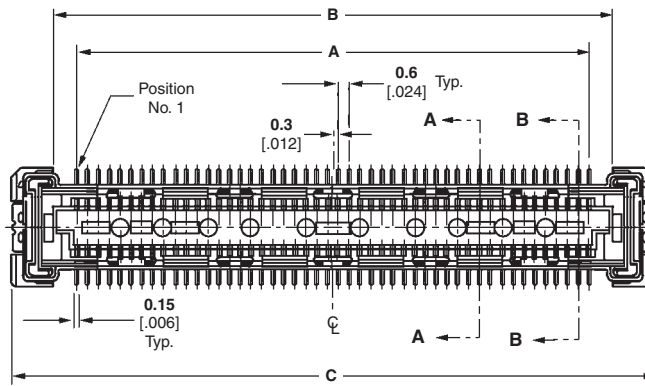

**Section A - A**  
(Ground Position)

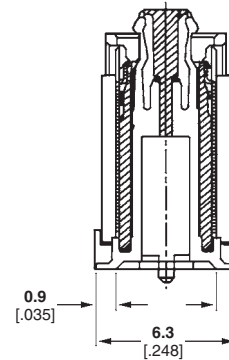

**Section B - B**  
(Signal Position)

Stacking Height	No. of Positions	Dimensions					Part Numbers (Tray Packaged)
		A	B	C	D	E	
8H	80	23.4 .921	26.0 1.024	30.7 2.087	26.6 1.047	7.25 .285	5316317-6
	50	14.4 .567	17.0 .670	21.7 .854	17.6 .693	11.25 .443	6318029-3
12H	140	41.4 1.630	44.0 1.732	48.7 1.917	44.6 1.756	11.25 .443	1-5316318-0
	160	47.4 1.866	50.0 1.969	54.7 2.154	50.6 1.992	11.25 .443	1-5316318-1

**Note:** Free Height (FH) receptacles for 4H (4mm) stacking height are shown on page 30. Part Numbers are RoHS compliant.

**0.6mm Free Height Standard Plugs, 0.6 [ .024] Pitch**

**4H (4mm), 5H (5mm)  
6H (6mm), 8H (8mm)  
and 12H (12mm)**

**Material and Finish**

**Housing** — High temperature thermoplastic, 94V-0 rated  
**Contacts** — Copper alloy; duplex plated 0.00020 [ .000008] min. gold on contact area, 0.00100 [ .000039] min. tin on solder area, with entire contact underplated 0.00130 [ .000051] min. nickel

**Related Product Data**

- Performance Characteristics** — page 27
- Stacking Height Combinations** — page 28
- Mating Receptacles** — pages 30, 31 & 34
- PC Board Layout** — pages 38 & 39

**Technical Documents** (page 113)

**Product Specification**  
108-5468

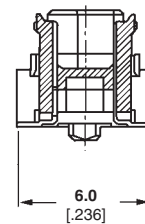
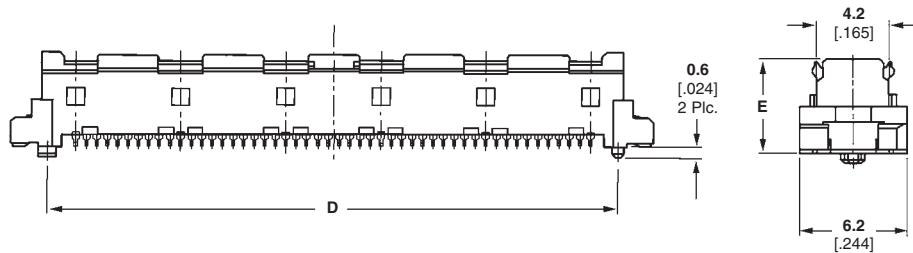
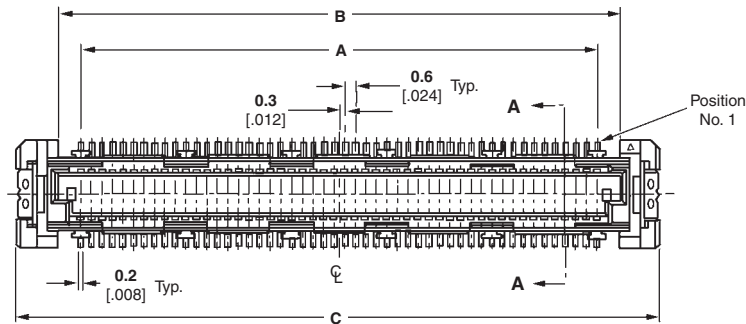

Section A - A

Stacking Height	No. of Positions	Dimensions					Part Numbers	
		A	B	C	D	E	Tray Packaged	Tape Packaged
4H	50	14.4 .567	17.0 .669	21.7 .854	17.6 .693	3.45 .136	5316135-3	5353183-3
	70	20.4 .803	23.0 .906	27.7 1.091	23.6 .929	3.45 .136	5316135-5	—
	100	29.4 1.158	32.0 1.260	36.7 1.445	32.6 1.284	3.45 .136	—	5353183-8
	140	41.4 1.630	44.0 1.732	48.7 1.917	44.6 1.756	3.45 .136	1-5316135-0	1-5353183-0
	160	47.4 1.866	50.0 1.969	54.7 2.154	50.6 1.992	3.45 .136	1-5316135-1	—
5H	50	14.4 .567	17.0 .669	21.7 .854	17.6 .693	4.45 .175	—	5-5353692-3
	100	29.4 1.158	32.0 1.260	36.7 1.445	32.6 1.284	5.45 .215	—	5353185-8
6H	140	41.4 1.630	44.0 1.732	48.7 1.917	44.6 1.756	5.45 .215	—	1-5353185-0
	140	41.4 1.630	44.0 1.732	48.7 1.917	44.6 1.756	7.45 .293	—	1-5353187-0
8H	160	47.4 1.866	50.0 1.969	54.7 2.154	50.6 1.992	7.45 .293	—	1-5353187-1
	12H	50	14.4 .567	17.0 .669	21.7 .854	17.6 .693	11.25 .443	6318026-3

**Note:** Part Numbers are RoHS compliant

0.6mm Free Height (FH) and GIGA Connectors

**0.6mm Free Height GIGA Plugs, 0.6 [.024] Pitch**

**4H (4mm), 5H (5mm),  
6H (6mm), 7H (7mm),  
8H (8mm) and 12H (12mm)**

**Note:** All GIGA plugs include ground plates that mate with receptacles with common ground contacts..

**Material and Finish**

**Housing** — High temperature thermoplastic, 94V-0 rated

**Contacts** — Copper alloy; duplex plated 0.00020 [.000008] min. gold on contact area, 0.00100 [.000039] min. tin on solder area, with entire contact underplated 0.00130 [.000051] min. nickel

**Ground Plates** — Phosphor bronze, plated 0.00300-0.00500 [.000120-.000200] tin over 0.00050 [.000020] copper

**Related Product Data**

**Performance Characteristics** — page 27

**Stacking Height Combinations** — page 28

**Mating Receptacles** — pages 30, 31, & 34

**PC Board Layout** — pages 23 & 24

**Technical Documents** (page 113)

**Product Specification**  
108-5468

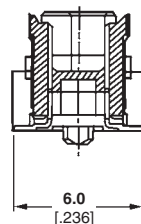
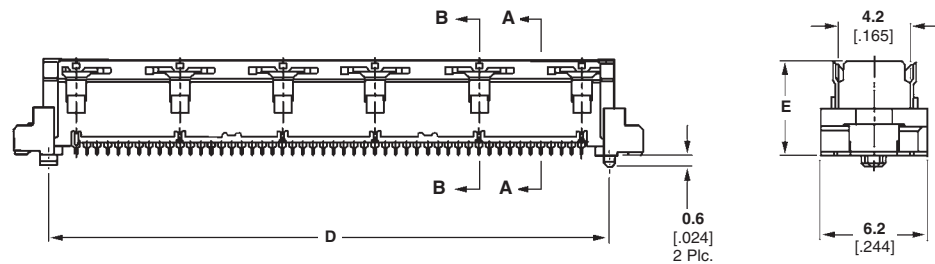
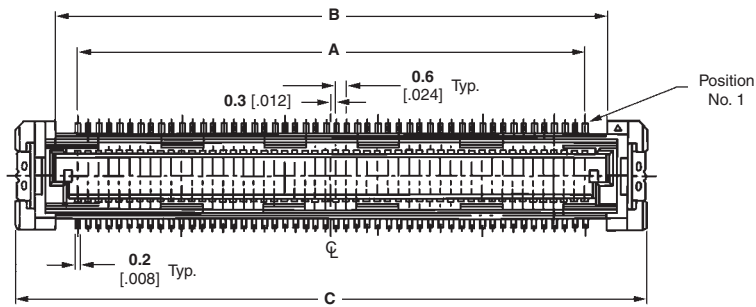

**Section A - A  
(Signal Position)**

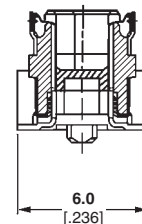

**Section B - B  
(Ground Position)**

Stacking Height	No. of Positions	Dimensions					Part Numbers	
		A	B	C	D	E	Tray Packaged	Tape Packaged
4H	50	14.4 .567	17.0 .669	21.7 .854	17.6 .693	3.45 .136	5316076-3	—
	70	20.4 .803	23.0 .906	27.7 1.091	23.6 .929	3.45 .136	—	5-5353184-5
	140	41.4 1.630	44.0 1.732	48.7 1.917	44.6 1.756	3.45 .136	1-5316076-0	1-5353184-0
	160	47.4 1.866	50.0 1.969	54.7 2.154	50.6 1.992	3.45 .136	1-5316559-1	—
5H	160	47.4 1.866	50.0 1.969	54.7 2.154	50.6 1.992	4.45 .175	1-5353471-1	—
6H	80	23.4 .921	26.0 1.024	30.7 1.209	26.6 1.047	5.45 .215	—	5353186-6
	140	41.4 1.630	44.0 1.732	48.7 1.917	44.6 1.756	5.45 .215	—	1-5353186-0
7H	80	23.4 .921	26.0 1.024	30.7 1.209	26.6 1.047	6.45 .254	—	5353831-6
	140	41.4 1.630	44.0 1.732	48.7 1.917	44.6 1.756	6.45 .254	—	1-5353831-0
8H	140	41.4 1.630	44.0 1.732	48.7 1.917	44.6 1.756	7.45 .293	—	1-5353188-0
	160	47.4 1.866	50.0 1.969	54.7 2.154	50.6 1.992	7.45 .293	1-5316562-1	1-5353188-1
12H	140	41.4 1.630	44.0 1.732	48.7 1.917	44.6 1.756	11.25 .443	6473225-1	—

**Note:** Part Numbers are RoHS compliant.



**0.6mm Free Height Bridged Receptacle, 0.6 [ .024] Pitch**

**4H and 12H Dual-Row**

**Note:** Receptacle includes common ground contacts that mate with standard plug assemblies or GIGA plug assemblies with ground plates.

**Material and Finish**

**Housing** — High temperature thermoplastic, 94V-0 rated

**Signal Contacts** — Copper alloy; duplex plated 0.00020 [.000008] min. gold on contact area, 0.00005 [.000002] min. gold on solder area, with entire contact underplated 0.00130 [.000051] min. nickel

**Ground Contacts** — Copper alloy; duplex plated 0.00020 [.000008] min. gold on contact area, 0.00100 [.000039] min. tin on solder area, with entire contact underplated 0.00130 [.000051] min. nickel

**Related Product Data**

**Performance Characteristics** — page 27

**Stacking Height Combinations** — page 28

**Mating Plugs** — pages 32, 33 & 35

**PC Board Layout** — page 37

**Technical Documents** (page 113)

**Product Specification**

108-5468

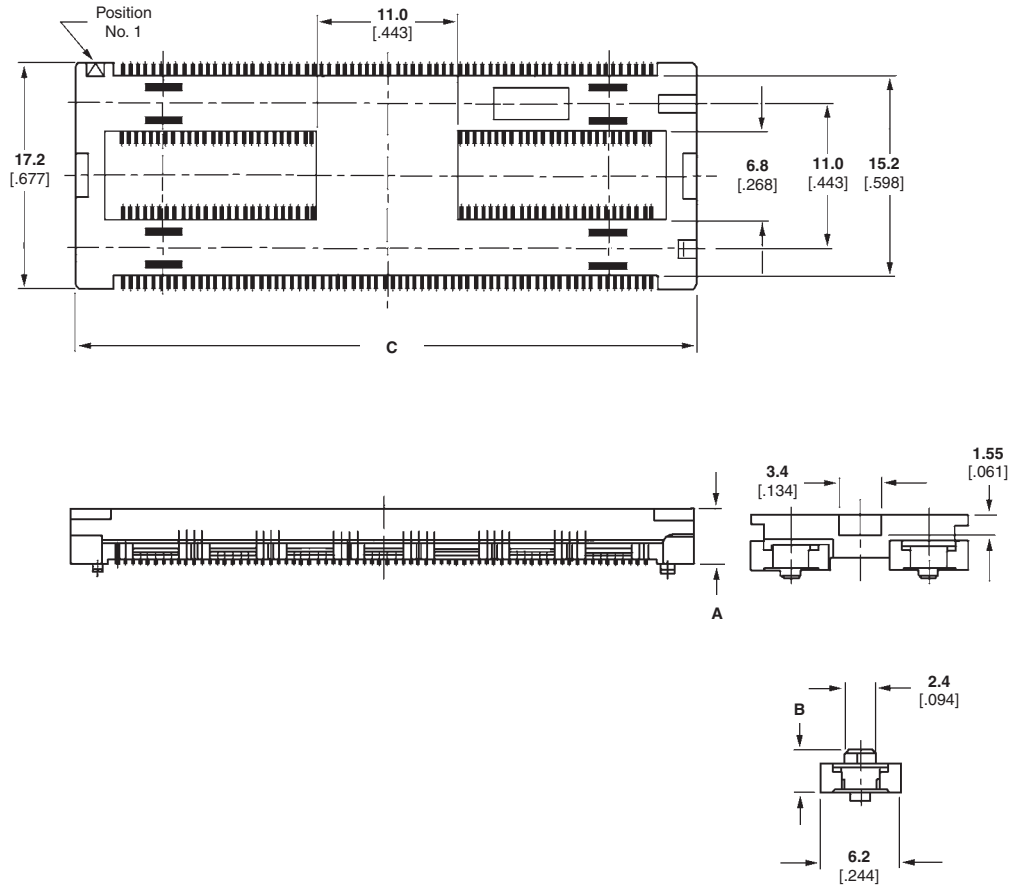

A	Dimensions		Ground Plate	Packaging	Positions	Height	Part Number
	B	C					
4.25 .167	3.25 .128	48.70 1.917	Yes	Tape	280	4H	1-5353206-0
4.25 .167	3.25 .128	48.70 1.917	Yes	Tray	280	4H	1-5353729-0
12.25 .482	11.25 .443	48.70 1.917	Yes	Tray	280	12H	1-5353800-0
4.25 .167	3.25 .128	54.70 2.154	Yes	Tray	320	4H	6-6318157-1

**Note:** Part Numbers are RoHS compliant.

0.6mm Free Height (FH) and GIGA Connectors

**0.6mm Free Height Bridged Plugs, 0.6 [.024] Pitch**

**4H, 6H, 8H and 12H  
Dual-Row**

**Material and Finish**

**Housing** — High temperature thermoplastic, 94V-0 rated

**Contacts** — Copper alloy; duplex plated 0.00020 [.000008] min. gold on contact area, 0.00100 [.000039] min. tin on solder area, with entire contact underplated 0.00130 [.000051] min. nickel

**Related Product Data**

**Performance Characteristics** — page 27

**Stacking Height Combinations** — page 28

**Mating Receptacles** — pages 30 & 34

**PC Board Layout** — page 39

**Technical Documents** (page 113)

**Product Specification**  
108-5468

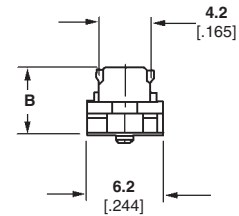
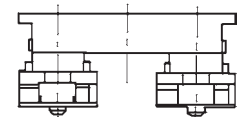
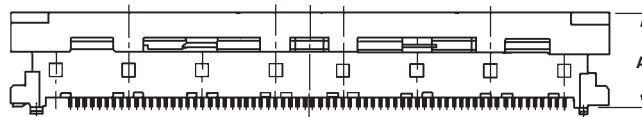
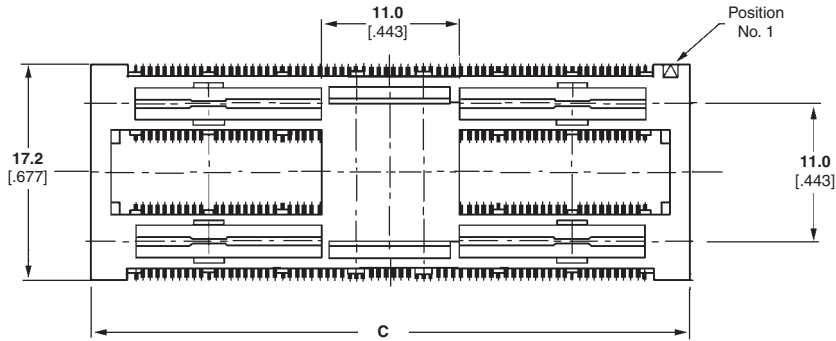

0.6mm Free Height (FH) and GIGA Connectors

Dimensions			Ground Plate	Packaging	Positions	Height	Part Number
A	B	C					
5.45 .215	3.45 .136	48.70 1.917	Yes	Tape	280	4H	1-5353231-0
5.45 .215	3.45 .136	48.70 1.917	No	Tape	280	4H	1-5353284-0
5.45 .215	3.45 .136	48.70 1.917	Yes	Tray	280	4H	1-5353720-0
7.45 .293	5.45 .215	48.70 1.917	Yes	Tape	280	6H	1-5353232-0
7.45 .293	5.45 .215	48.70 1.917	Yes	Tray	280	6H	1-6123086-0
7.45 .293	5.45 .215	48.70 1.917	No	Tape	280	6H	1-5353134-0
9.45 .372	7.45 .293	48.70 1.917	No	Tape	280	8H	1-5353135-0
9.45 .372	7.45 .293	48.70 1.917	Yes	Tape	280	8H	1-5353233-0
9.45 .372	7.45 .293	48.70 1.917	Yes	Tray	280	8H	1-5353727-0
13.45 .530	11.45 .451	48.70 1.917	Yes	Tray	280	12H	1-6123098-0
5.45 .215	3.45 .136	54.70 2.154	Yes	Tray	320	4H	6-6318151-1
9.45 .372	7.45 .293	54.70 2.154	Yes	Tray	320	8H	6-6318154-1

**Note:** Part Numbers are RoHS compliant.

**Recommended PC Board Layouts and Grounding Circuit Positions**

For 50-, 70-, 80- and 100-Position Receptacles

Stacking Height	Dimensions	
	A	B
4H	1.5 .059	3.6 .142
8H	1.75 .069	3.8 .150
12H	1.75 .069	3.8 .150

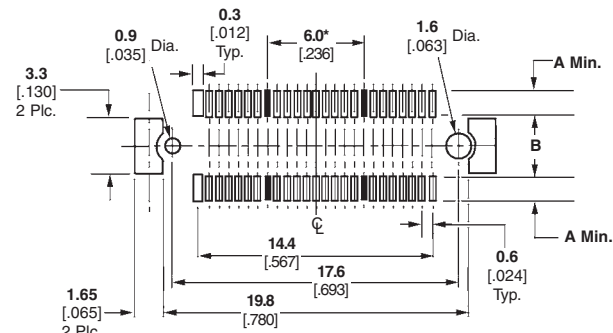

**For 50-Position Receptacles**  
\*Spacing between grounding circuits

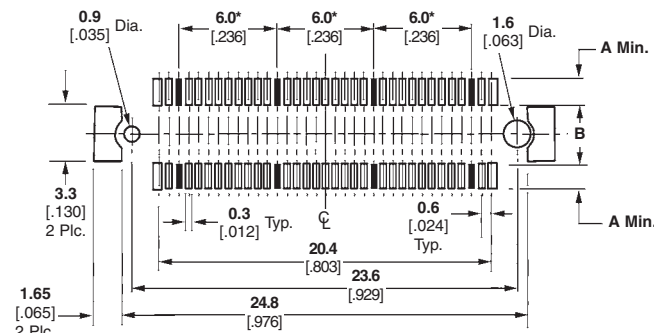

**For 70-Position Receptacles**  
\*Spacing between grounding circuits

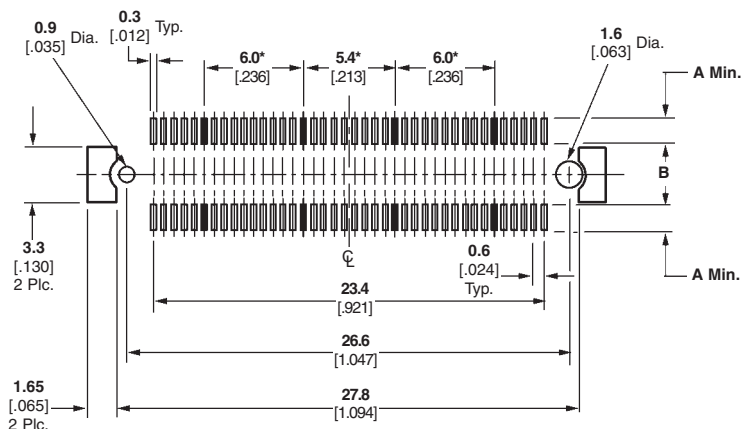

**For 80-Position Receptacles**  
\*Spacing between grounding circuits

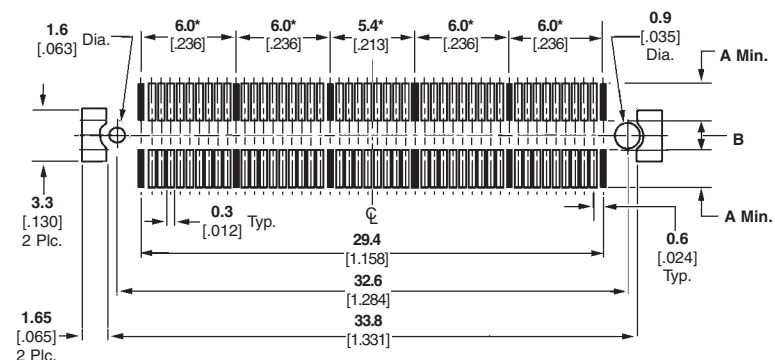

**For 100-Position Standard Receptacles**  
\*Spacing between grounding circuits

0.6mm Free Height (FH) and GIGA Connectors

**Recommended PC Board Layouts and Grounding Circuit Positions (Continued)**

**For 140-, 160-Position Receptacles and 280-Position Bridge Receptacle**

Stacking Height	Dimensions	
	A	B
4H	1.5 .059	3.6 .142
12H	1.75 .069	3.8 .150

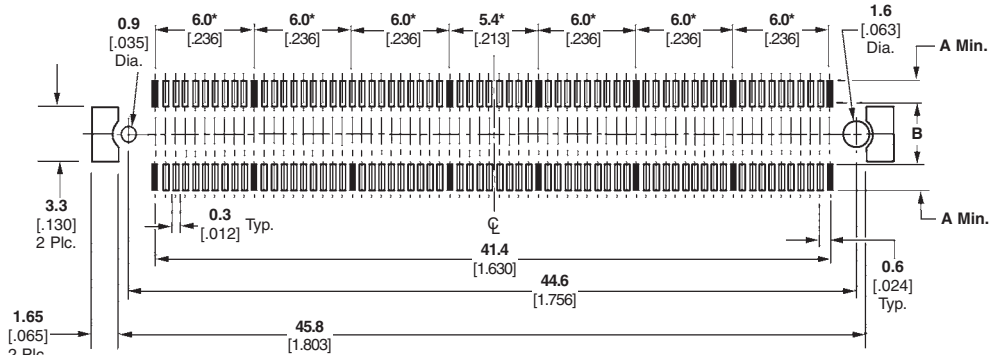

**For 140-Position Receptacles**  
\*Spacing between grounding circuits

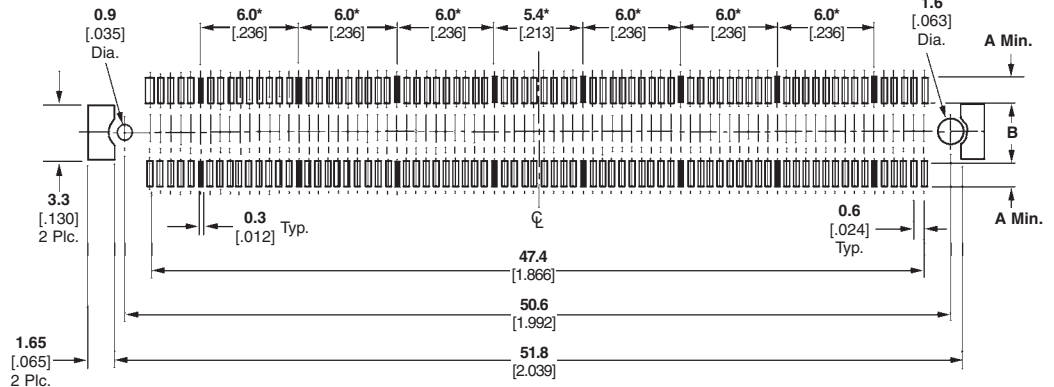

**For 160-Position Receptacles**  
\*Spacing between grounding circuits

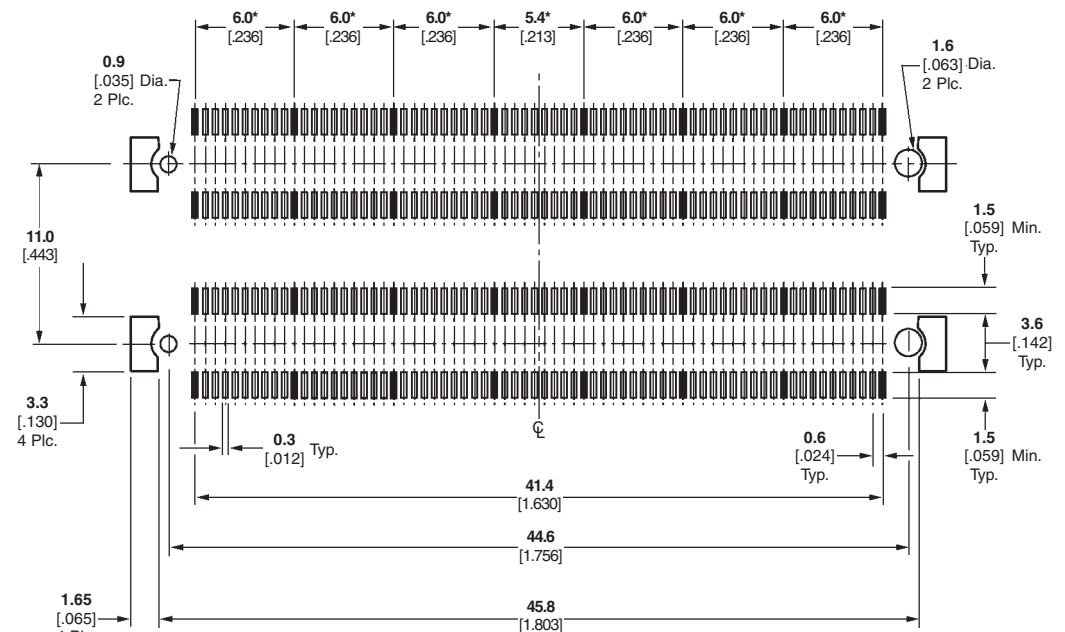

**For 280-Position Bridge Receptacle**  
\*Spacing between grounding circuits

0.6mm Free Height (FH) and GIGA Connectors

0.6mm Free Height (FH) and GIGA Connectors

**Recommended PC Board Layouts and Grounding Circuit Positions (Continued)**

**For 50-, 70-, 100- and 140-Position Standard Plugs**

Stacking Height	Dimensions	
	A	B
4H	2.35 .093	1.9 .075
5H	1.8 .071	3.4 .134
6H	1.8 .071	3.4 .134
8H	1.8 .071	3.4 .134

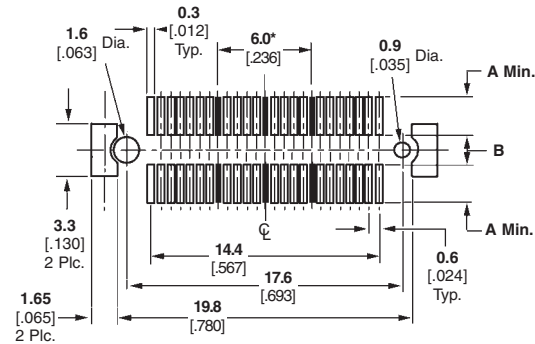

**For 50-Position Standard Plugs**  
\*Spacing between grounding circuits

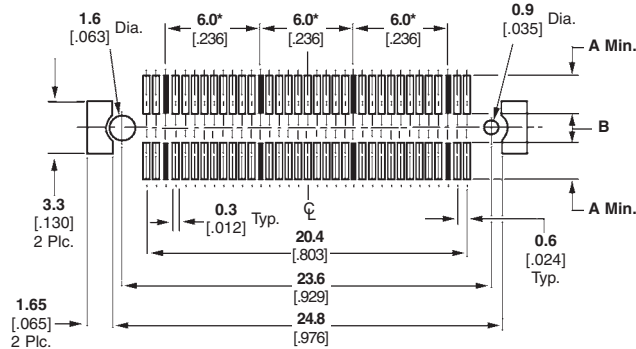

**For 70-Position Standard Plugs**  
\*Spacing between grounding circuits

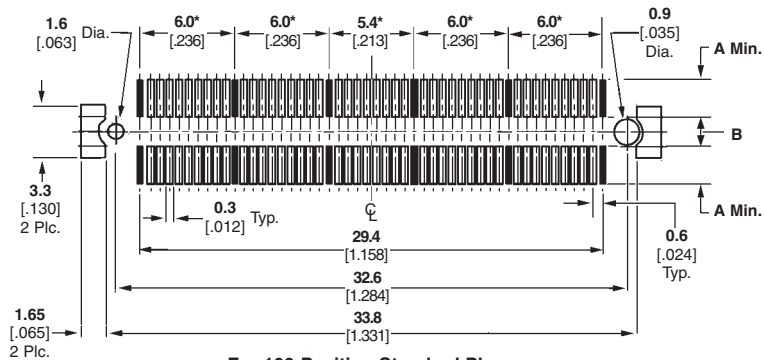

**For 100-Position Standard Plugs**  
\*Spacing between grounding circuits

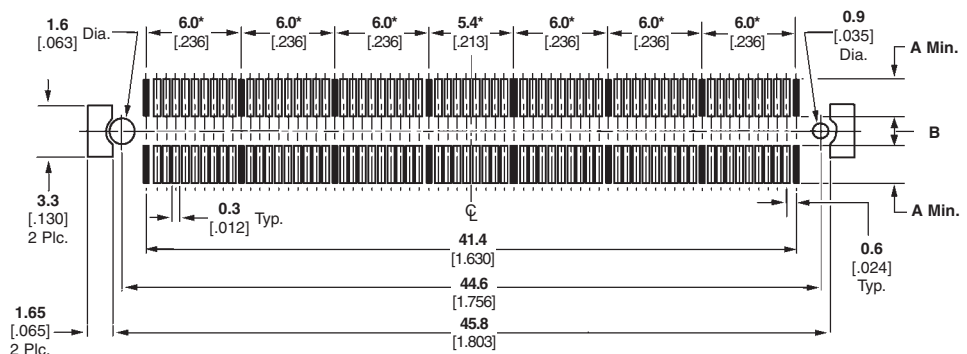

**For 140-Position Standard Plugs**  
\*Spacing between grounding circuits

0.6mm Free Height (FH) and GIGA Connectors

**Recommended PC Board Layouts and Grounding Circuit Positions (Continued)**

**For 160-Position Standard Plugs and 280-Position Standard Bridge Plugs**

Stacking Height	Dimensions	
	A	B
4H	2.35 .093	1.9 .075
6H	1.8 .071	3.4 .134
8H	1.8 .071	3.4 .134

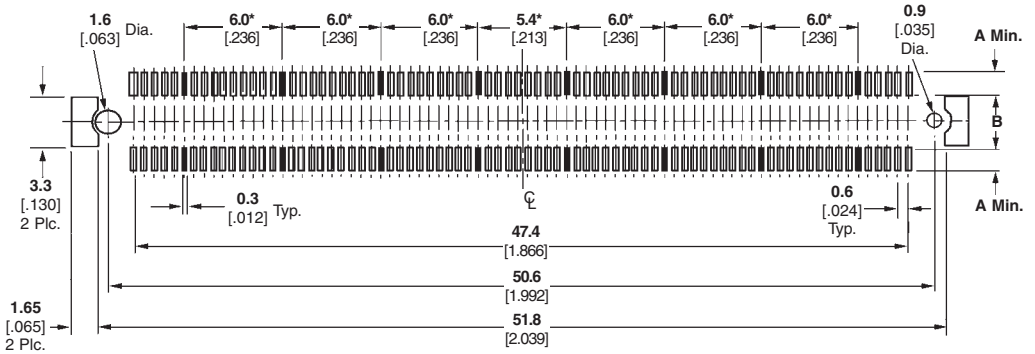

**For 160-Position Standard Plugs**  
\*Spacing between grounding circuits

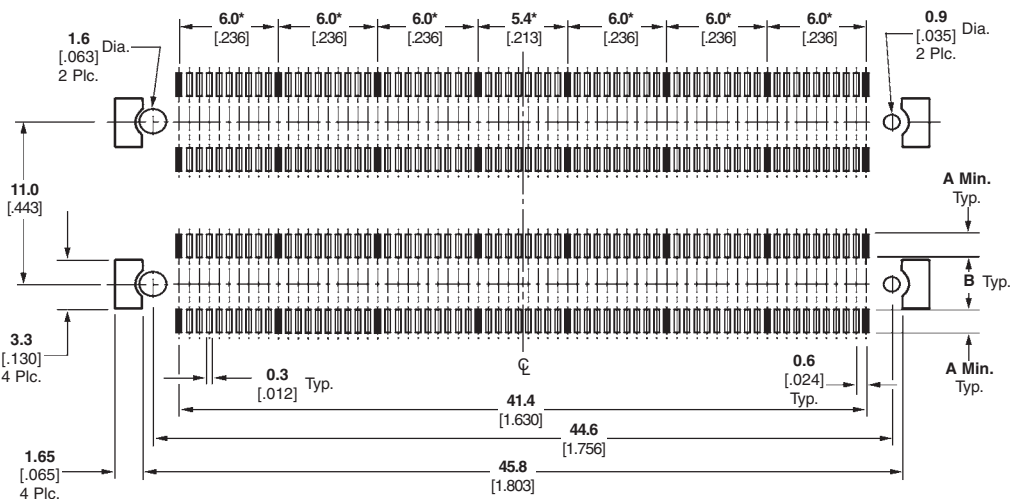

**For 280-Position Standard Bridge Plugs**  
\*Spacing between grounding circuits

**For 50-, 70- and 80-Position GIGA Plugs**

Stacking Height	Dimensions	
	A	B
4H	2.35 .093	1.9 .075
6H	1.8 .071	3.4 .134
7H	1.8 .071	3.4 .134

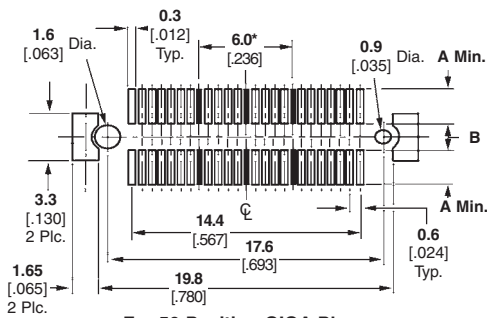

**For 50-Position GIGA Plugs**  
\*Spacing between grounding circuits

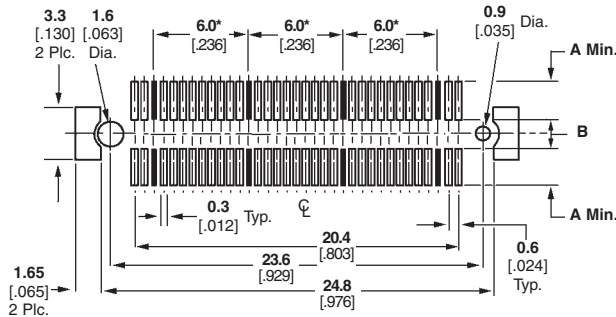

**For 70-Position GIGA Plugs**  
\*Spacing between grounding circuits

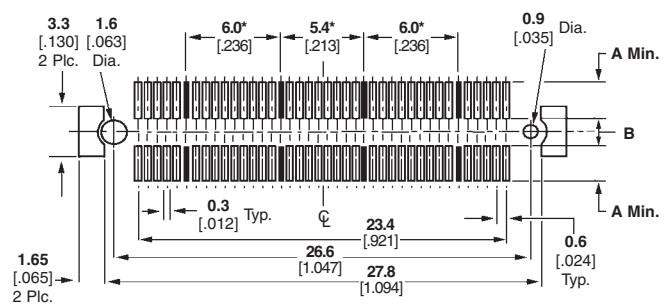

**For 80-Position GIGA Plugs**  
\*Spacing between grounding circuits

**Recommended PC Board Layouts and Grounding Circuit Positions (Continued)**

For 140- and 160-position GIGA Plugs and 280-Position GIGA Bridge Plugs

Stacking Height	Dimensions	
	A	B
4H	2.35 .093	1.9 .075
5H	1.8 .071	3.4 .134
6H	1.8 .071	3.4 .134
7H	1.8 .071	3.4 .134
8H	1.8 .071	3.4 .134

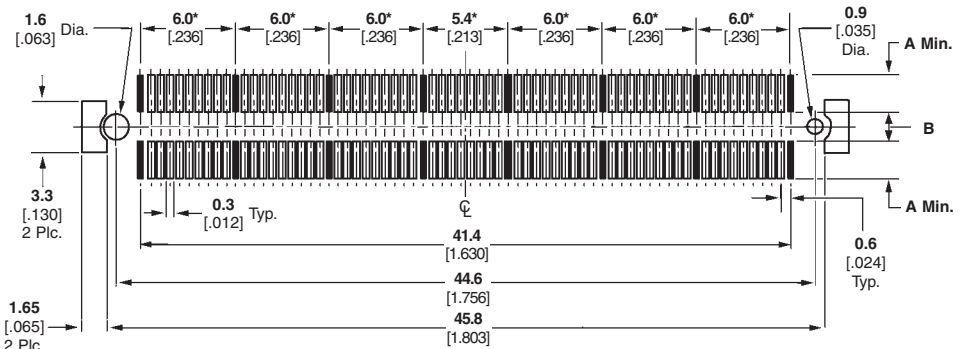

For 140-Position GIGA Plugs  
\*Spacing between grounding circuits

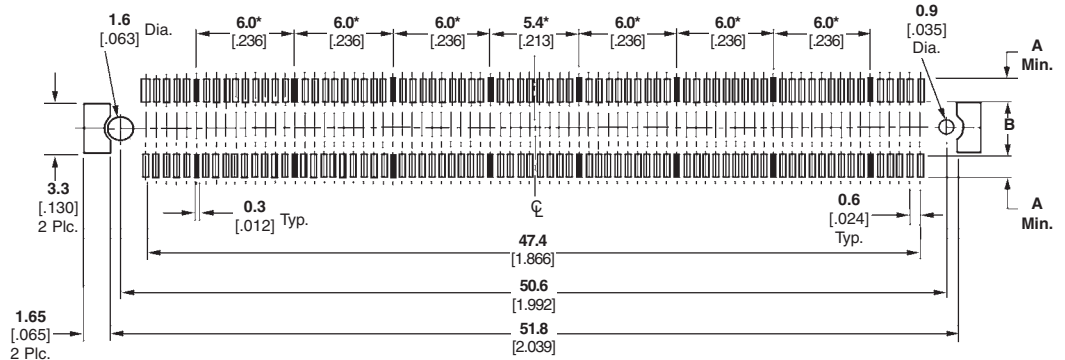

For 160-Position GIGA Plugs  
\*Spacing between grounding circuits

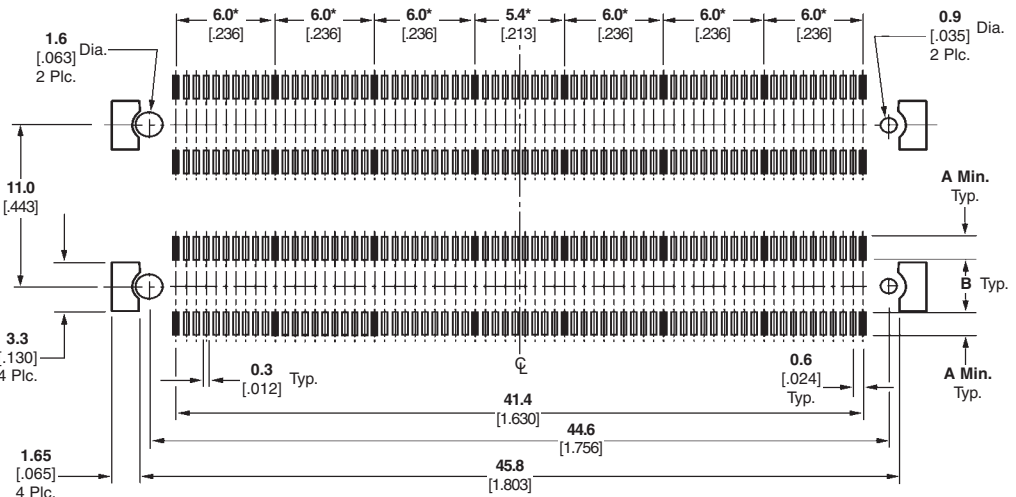

For 280-Position GIGA Bridge Plugs  
\*Spacing between grounding circuits

0.6mm Free Height (FH) and GIGA Connectors