

### General Description

The AO4488 uses advanced trench technology to provide excellent  $R_{DS(ON)}$  with low gate charge. This device is ESD protected and it is suitable for use as a load switch or in PWM applications.

### Product Summary

$V_{DS}$  (V) = 30V  
 $I_D$  = 20A ( $V_{GS} = 10V$ )  
 $R_{DS(ON)} < 4.6m\Omega$  ( $V_{GS} = 10V$ )  
 $R_{DS(ON)} < 6.4m\Omega$  ( $V_{GS} = 4.5V$ )

ESD Protected  
 100% UIS Tested  
 100% Rg Tested



SOIC-8

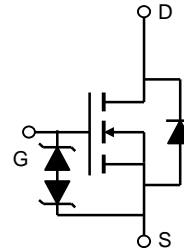
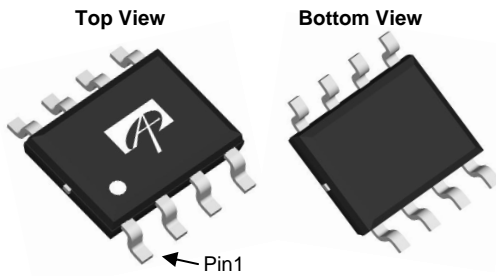

### Absolute Maximum Ratings $T_A=25^\circ\text{C}$ unless otherwise noted

Parameter	Symbol	10 Sec	Steady State	Units	
Drain-Source Voltage	$V_{DS}$	30		V	
Gate-Source Voltage	$V_{GS}$	$\pm 20$		V	
Continuous Drain Current <sup>A</sup>	$I_D$	$T_A=25^\circ\text{C}$	20	15	A
		$T_A=70^\circ\text{C}$	17	12	
Pulsed Drain Current <sup>B</sup>	$I_{DM}$	80			
Avalanche Current <sup>G</sup>	$I_{AR}$	50			
Repetitive avalanche energy $L=0.3\text{mH}$ <sup>G</sup>	$E_{AR}$	375		mJ	
Power Dissipation <sup>A</sup>	$P_D$	$T_A=25^\circ\text{C}$	3.1	1.7	W
		$T_A=70^\circ\text{C}$	2.0	1.1	
Junction and Storage Temperature Range	$T_J, T_{STG}$	-55 to 150		$^\circ\text{C}$	

### Thermal Characteristics

Parameter	Symbol	Typ	Max	Units
Maximum Junction-to-Ambient <sup>A</sup>	$R_{\theta JA}$	31	40	$^\circ\text{C/W}$
Maximum Junction-to-Ambient <sup>A</sup>		Steady State	59	75
Maximum Junction-to-Lead <sup>C</sup>	$R_{\theta JL}$	16	24	$^\circ\text{C/W}$

Electrical Characteristics (T<sub>J</sub>=25°C unless otherwise noted)

Symbol	Parameter	Conditions	Min	Typ	Max	Units
<b>STATIC PARAMETERS</b>						
B <sub>V</sub> DSS	Drain-Source Breakdown Voltage	I <sub>D</sub> = 250μA, V <sub>GS</sub> = 0V	30	35.5		V
I <sub>DSS</sub>	Zero Gate Voltage Drain Current	V <sub>DS</sub> = 30V, V <sub>GS</sub> = 0V T <sub>J</sub> = 55°C			1 5	μA
I <sub>GSS</sub>	Gate-Body leakage current	V <sub>DS</sub> = 0V, V <sub>GS</sub> = ±16V			±10	
V <sub>GS(th)</sub>	Gate Threshold Voltage	V <sub>DS</sub> = V <sub>GS</sub> , I <sub>D</sub> = 250μA	1.0	1.7	2.5	V
I <sub>D(ON)</sub>	On state drain current	V <sub>GS</sub> = 10V, V <sub>DS</sub> = 5V	80			A
R <sub>DS(ON)</sub>	Static Drain-Source On-Resistance	V <sub>GS</sub> = 10V, I <sub>D</sub> = 20A T <sub>J</sub> = 125°C		3.8 5.3	4.6 6.5	mΩ
		V <sub>GS</sub> = 4.5V, I <sub>D</sub> = 18A		5.2	6.4	
g <sub>FS</sub>	Forward Transconductance	V <sub>DS</sub> = 5V, I <sub>D</sub> = 20A		72		S
V <sub>SD</sub>	Diode Forward Voltage	I <sub>S</sub> = 1A, V <sub>GS</sub> = 0V		0.69	1	V
I <sub>S</sub>	Maximum Body-Diode Continuous Current				3	A
<b>DYNAMIC PARAMETERS</b>						
C <sub>iss</sub>	Input Capacitance	V <sub>GS</sub> = 0V, V <sub>DS</sub> = 15V, f = 1MHz		5450	6800	pF
C <sub>oss</sub>	Output Capacitance			760		pF
C <sub>rss</sub>	Reverse Transfer Capacitance			540		pF
R <sub>g</sub>	Gate resistance	V <sub>GS</sub> = 0V, V <sub>DS</sub> = 0V, f = 1MHz		1	1.5	Ω
<b>SWITCHING PARAMETERS</b>						
Q <sub>g</sub> (10V)	Total Gate Charge	V <sub>GS</sub> = 10V, V <sub>DS</sub> = 15V, I <sub>D</sub> = 20A		84	112	nC
Q <sub>g</sub> (4.5V)	Total Gate Charge			42	56	nC
Q <sub>gs</sub>	Gate Source Charge			12		nC
Q <sub>gd</sub>	Gate Drain Charge			21		nC
t <sub>D(on)</sub>	Turn-On Delay Time	V <sub>GS</sub> = 10V, V <sub>DS</sub> = 15V, R <sub>L</sub> = 0.75Ω, R <sub>GEN</sub> = 3Ω		13		ns
t <sub>r</sub>	Turn-On Rise Time			9.8		ns
t <sub>D(off)</sub>	Turn-Off Delay Time			49		ns
t <sub>f</sub>	Turn-Off Fall Time			16		ns
t <sub>rr</sub>	Body Diode Reverse Recovery Time	I <sub>F</sub> = 20A, dI/dt = 100A/μs		42	56	ns
Q <sub>rr</sub>	Body Diode Reverse Recovery Charge	I <sub>F</sub> = 20A, dI/dt = 100A/μs		31		nC

A: The value of R<sub>θJA</sub> is measured with the device mounted on 1 in<sup>2</sup> FR-4 board with 2oz. Copper, in a still air environment with T<sub>A</sub> = 25°C. The value in any given application depends on the user's specific board design. The current rating is based on the t ≤ 10s thermal resistance rating.

B: Repetitive rating, pulse width limited by junction temperature.

C: The R<sub>θJA</sub> is the sum of the thermal impedance from junction to lead R<sub>θJL</sub> and lead to ambient.

D: The static characteristics in Figures 1 to 6 are obtained using < 300μs pulses, duty cycle 0.5% max.

E: These tests are performed with the device mounted on 1 in<sup>2</sup> FR-4 board with 2oz. Copper, in a still air environment with T<sub>A</sub> = 25°C. The SOA curve provides a single pulse rating.

F: The current rating is based on the t ≤ 10s thermal resistance rating.

G: E<sub>AR</sub> and I<sub>AR</sub> ratings are based on low frequency and duty cycles to keep T<sub>J</sub> = 25°C.

Rev6: Nov. 2010

THIS PRODUCT HAS BEEN DESIGNED AND QUALIFIED FOR THE CONSUMER MARKET. APPLICATIONS OR USES AS CRITICAL COMPONENTS IN LIFE SUPPORT DEVICES OR SYSTEMS ARE NOT AUTHORIZED. AOS DOES NOT ASSUME ANY LIABILITY ARISING OUT OF SUCH APPLICATIONS OR USES OF ITS PRODUCTS. AOS RESERVES THE RIGHT TO IMPROVE PRODUCT DESIGN, FUNCTIONS AND RELIABILITY WITHOUT NOTICE.

TYPICAL ELECTRICAL AND THERMAL CHARACTERISTICS

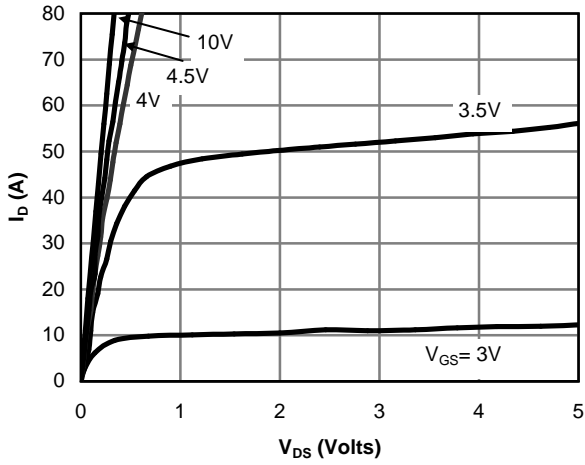

Figure 1: On-Region Characteristics

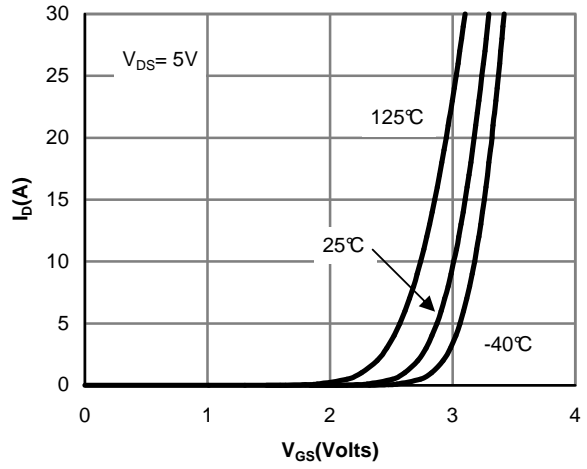

Figure 2: Transfer Characteristics

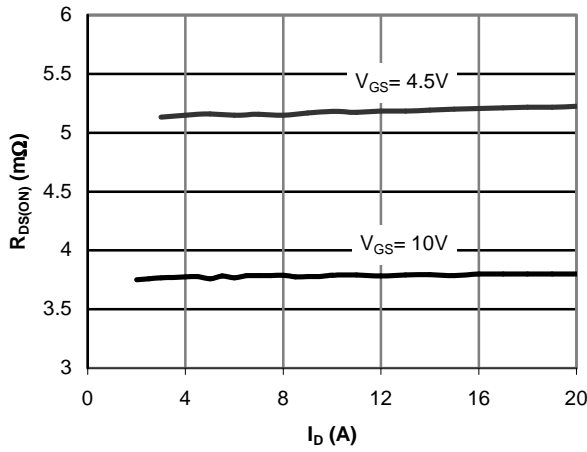

Figure 3: On-Resistance vs. Drain Current and Gate Voltage

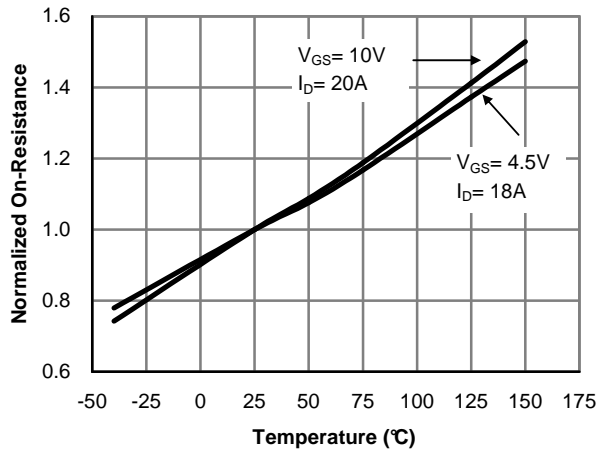

Figure 4: On-Resistance vs. Junction Temperature

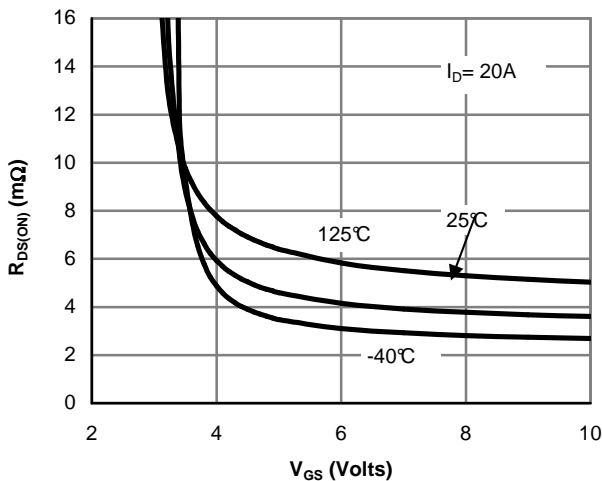

Figure 5: On-Resistance vs. Gate-Source Voltage

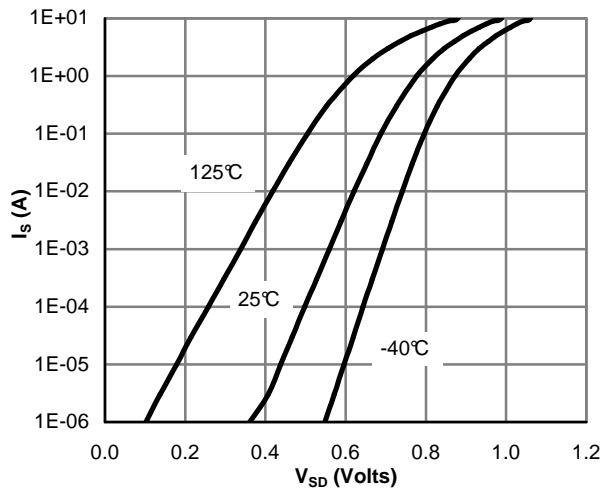

Figure 6: Body-Diode Characteristics

TYPICAL ELECTRICAL AND THERMAL CHARACTERISTICS

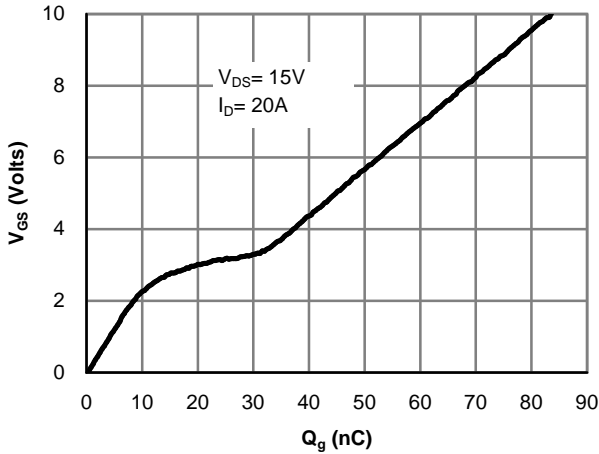

Figure 7: Gate-Charge Characteristics

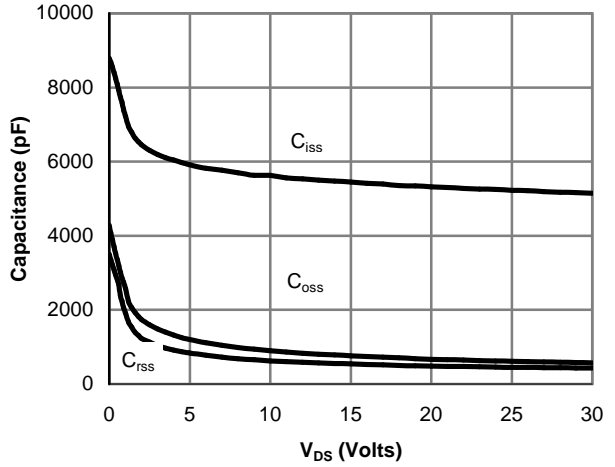

Figure 8: Capacitance Characteristics

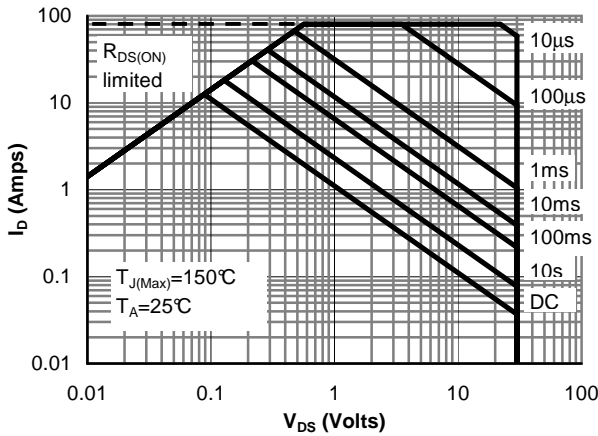

Figure 9: Maximum Forward Biased Safe Operating Area (Note E)

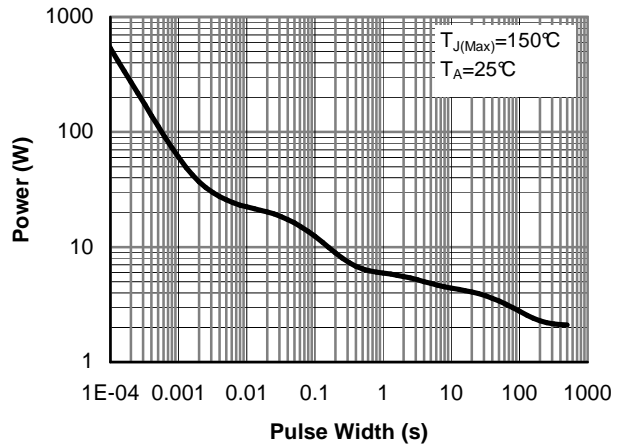

Figure 10: Single Pulse Power Rating Junction-to-Ambient (Note E)

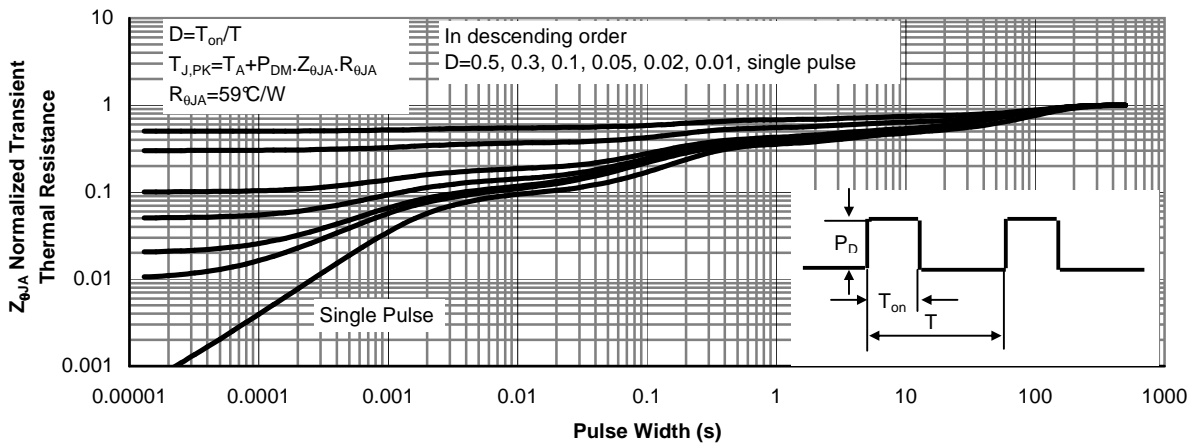
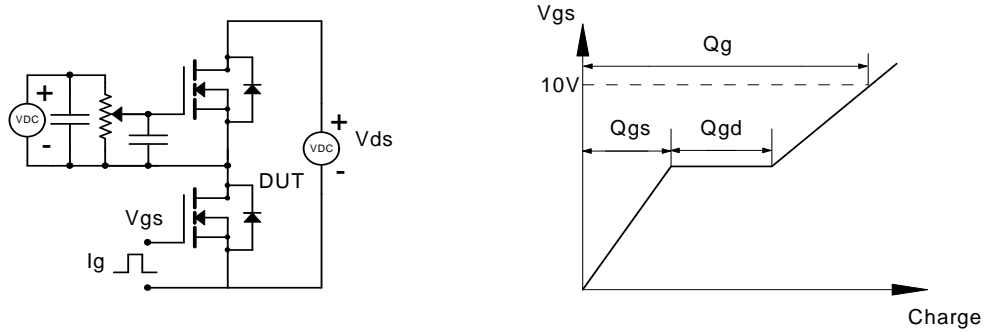
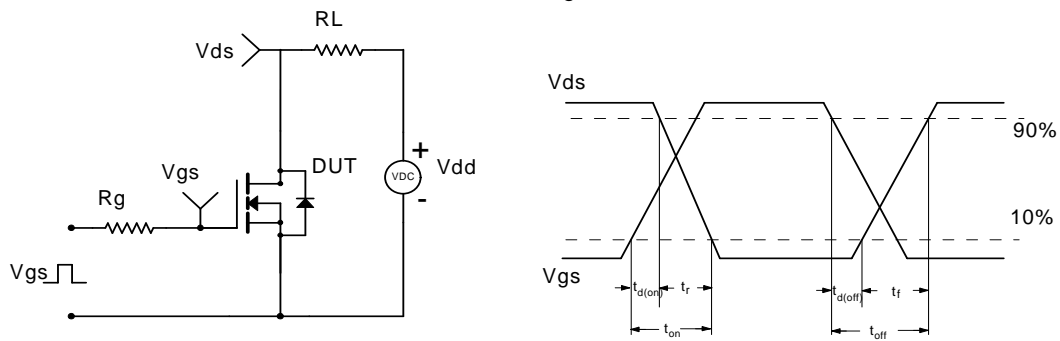

Figure 11: Normalized Maximum Transient Thermal Impedance (Note E)

Gate Charge Test Circuit & Waveform



Resistive Switching Test Circuit & Waveforms



Unclamped Inductive Switching (UIS) Test Circuit & Waveforms

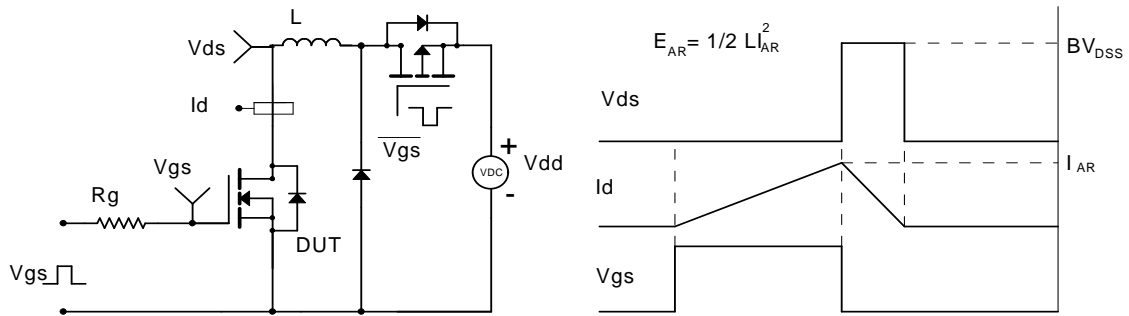

Diode Recovery Test Circuit & Waveforms

