

Trench Gate Power MOSFET

IXTA76N25T IXTH76N25T
IXTI76N25T IXTP76N25T
IXTQ76N25T

$V_{DSS} = 250V$
 $I_{D25} = 76A$
 $R_{DS(on)} \leq 39m\Omega$

N-Channel Enhancement Mode

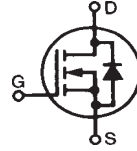

Typical avalanche BV = 300V

TO-263 (IXTA)

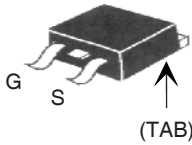

TO-247 (IXTH)

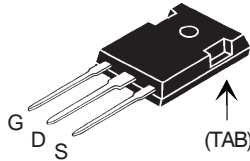

TO-262 (IXTI)

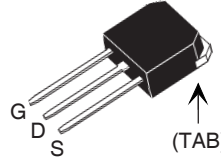

TO-220 (IXTP)

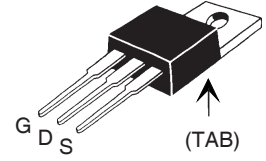

Symbol	Test Conditions	Maximum Ratings	
V_{DSS}	$T_J = 25^\circ C$ to $150^\circ C$	250	V
V_{DGR}	$T_J = 25^\circ C$ to $150^\circ C$, $R_{GS} = 1M\Omega$	250	V
V_{GSM}	Transient	± 30	V
I_{D25}	$T_C = 25^\circ C^*$	76	A
I_{DM}	$T_C = 25^\circ C$, pulse width limited by T_{JM}	170	A
I_{AS}	$T_C = 25^\circ C$	8	A
E_{AS}	$T_C = 25^\circ C$	1.5	J
P_D	$T_C = 25^\circ C$	460	W
T_J		-55 ... +150	$^\circ C$
T_{JM}		150	$^\circ C$
T_{stg}		-55 ... +150	$^\circ C$
T_L	1.6mm (0.062in.) from case for 10s	300	$^\circ C$
	Plastic body for 10seconds	260	$^\circ C$
M_d	Mounting Torque TO-220,TO-3P,TO247	1.13 / 10	Nm/lb.in.
F_c	Mounting Force TO-262,TO-263	10..65 / 2.2..14.6	N/lb.
Weight			
	TO-262,TO-263	2.5	g
	TO-220	3.0	g
	TO-3P	5.5	g
	TO-247	6.0	g

TO-3P (IXTQ)

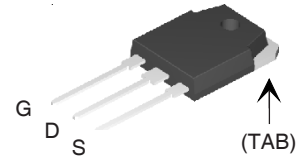

G = Gate D = Drain
S = Source TAB = Drain

Features

- International standard packages
- Avalanche rated
- Low package inductance
 - easy to drive and to protect

Advantages

- Easy to mount
- Space savings
- High power density

Applications

- DC-DC converters
- Battery chargers
- Switched-mode and resonant-mode power supplies
- DC choppers
- AC motor control
- Uninterruptible power supplies
- High speed power switching applications

Symbol	Test Conditions ($T_J = 25^\circ C$ unless otherwise specified)	Characteristic Values		
		Min.	Typ.	Max.
BV_{DSS}	$V_{GS} = 0V, I_D = 1mA$ $V_{GS} = 0V, I_D = 10A$	250	300	V
$V_{GS(th)}$	$V_{DS} = V_{GS}, I_D = 1mA$	3		5 V
I_{GSS}	$V_{GS} = \pm 20V, V_{DS} = 0V$			± 100 nA
I_{DSS}	$V_{DS} = V_{DSS}$ $V_{GS} = 0V$ $T_J = 125^\circ C$			2 μA 200 μA
$R_{DS(on)}$	$V_{GS} = 10V, I_D = 0.5 \cdot I_{D25}$ Note 1			39 m Ω

Symbol	Test Conditions ($T_J = 25^\circ\text{C}$ unless otherwise specified)	Characteristic Values		
		Min.	Typ.	Max.
g_{fs}	$V_{DS} = 10\text{V}, I_D = 0.5 \cdot I_{D25}$, Note 1	43	72	S
C_{iss}	$V_{GS} = 0\text{V}, V_{DS} = 25\text{V}, f = 1\text{MHz}$		4500	pF
C_{oss}			480	pF
C_{rss}			46	pF
$t_{d(on)}$	Resistive Switching Times $V_{GS} = 15\text{V}, V_{DS} = 0.5 \cdot V_{DSS}, I_D = 0.5 \cdot I_{D25}$ $R_G = 3.3\Omega$ (External)		22	ns
t_r			25	ns
$t_{d(off)}$			56	ns
t_f			29	ns
$Q_{g(on)}$	$V_{GS} = 10\text{V}, V_{DS} = 0.5 \cdot V_{DSS}, I_D = 25\text{A}$		92	nC
Q_{gs}			28	nC
Q_{gd}			21	nC
R_{thJC}	TO-220 TO-3P, TO-247			0.27 $^\circ\text{C/W}$
R_{thCH}			0.50	$^\circ\text{C/W}$
			0.21	$^\circ\text{C/W}$

Source-Drain Diode

Symbol	Test Conditions ($T_J = 25^\circ\text{C}$ unless otherwise specified)	Characteristic Values		
		Min.	Typ.	Max.
I_S	$V_{GS} = 0\text{V}$			76 A
I_{SM}	Repetitive, pulse width limited by T_{JM}			200 A
V_{SD}	$I_F = I_S, V_{GS} = 0\text{V}$, Note 1			1.5 V
t_{rr}	$I_F = 38\text{A}, -di/dt = 250\text{A}/\mu\text{s}$ $V_R = 100\text{V}, V_{GS} = 0\text{V}$		148	ns
I_{RM}			21	A
Q_{RM}			1.6	μC

Notes: 1: Pulse test, $t \leq 300\mu\text{s}$; duty cycle, $d \leq 2\%$.
*: Current may be limited by external lead limit.

PRELIMINARY TECHNICAL INFORMATION

The product presented herein is under development. The Technical Specifications offered are derived from data gathered during objective characterizations of preliminary engineering lots; but also may yet contain some information supplied during a pre-production design evaluation. IXYS reserves the right to change limits, test conditions, and dimensions without notice.

IXYS reserves the right to change limits, test conditions, and dimensions.

TO-263 (IXTA) Outline

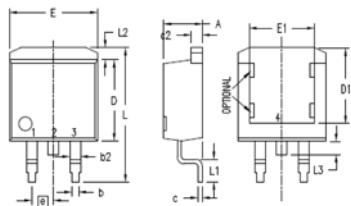

1. GATE
2. DRAIN (COLLECTOR)
3. SOURCE (EMITTER)
4. DRAIN (COLLECTOR) BOTTOM SIDE

SYM	INCHES		MILLIMETERS	
	MIN	MAX	MIN	MAX
A	.160	.190	4.06	4.83
A1	.080	.110	2.03	2.79
b	.020	.039	0.51	0.99
b2	.045	.055	1.14	1.40
c	.016	.029	0.40	0.74
c2	.045	.055	1.14	1.40
D	.340	.380	8.64	9.65
D1	.315	.350	8.00	8.89
E	.380	.410	9.65	10.41
E1	.245	.320	6.22	8.13
e	.100 BSC		2.54 BSC	
L	.575	.625	14.61	15.88
L1	.090	.110	2.29	2.79
L2	.040	.055	1.02	1.40
L3	.050	.070	1.27	1.78
L4	0	.005	0	0.13

TO-220 (IXTP) Outline

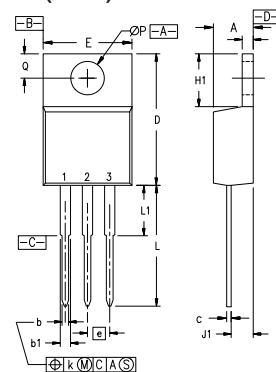

- Pins: 1 - Gate 2 - Drain

SYM	INCHES		MILLIMETERS	
	MIN	MAX	MIN	MAX
A	.170	.190	4.32	4.83
b	.025	.040	0.64	1.02
b1	.045	.065	1.15	1.65
c	.014	.022	0.35	0.56
D	.580	.630	14.73	16.00
E	.390	.420	9.91	10.66
e	.100 BSC		2.54 BSC	
F	.045	.055	1.14	1.40
H1	.230	.270	5.85	6.85
J1	.090	.110	2.29	2.79
k	0	.015	0	0.38
L	.500	.550	12.70	13.97
L1	.110	.230	2.79	5.84
ØP	.139	.161	3.53	4.08
Q	.100	.125	2.54	3.18

TO-247 (IXTH) Outline

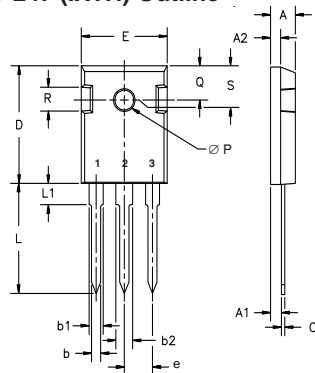

- Terminals: 1 - Gate 2 - Drain
3 - Source Tab - Drain

Dim.	Millimeter		Inches	
	Min.	Max.	Min.	Max.
A	4.7	5.3	.185	.209
A ₁	2.2	2.54	.087	.102
A ₂	2.2	2.6	.059	.098
b	1.0	1.4	.040	.055
b ₁	1.65	2.13	.065	.084
b ₂	2.87	3.12	.113	.123
C	.4	.8	.016	.031
D	20.80	21.46	.819	.845
E	15.75	16.26	.610	.640
e	5.20	5.72	0.205	0.225
L	19.81	20.32	.780	.800
L1		4.50		.177
ØP	3.55	3.65	.140	.144
Q	5.89	6.40	0.232	0.252
R	4.32	5.49	.170	.216
S	6.15 BSC		242 BSC	

TO-3P (IXTQ) Outline

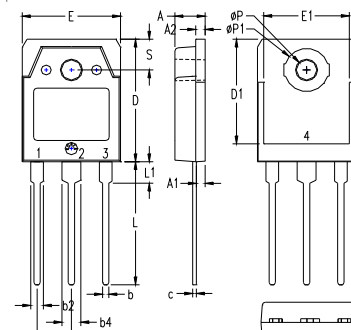

- 1 - GATE
- 2 - DRAIN (COLLECTOR)
- 3 - SOURCE (EMITTER)
- 4 - DRAIN (COLLECTOR)

SYM	INCHES		MILLIMETERS	
	MIN	MAX	MIN	MAX
A	.185	.193	4.70	4.90
A1	.051	.059	1.30	1.50
A2	.057	.065	1.45	1.65
b	.035	.045	0.90	1.15
b2	.075	.087	1.90	2.20
b4	.114	.126	2.90	3.20
c	.022	.031	0.55	0.80
D	.780	.799	19.80	20.30
D1	.665	.677	16.90	17.20
E	.610	.622	15.50	15.80
E1	.531	.539	13.50	13.70
e	.215 BSC		5.45 BSC	
L	.779	.795	19.80	20.20
L1	.134	.142	3.40	3.60
ØP	.126	.134	3.20	3.40
ØP1	.272	.280	6.90	7.10
S	.193	.201	4.90	5.10

Leaded 262 (IXTI) Outline

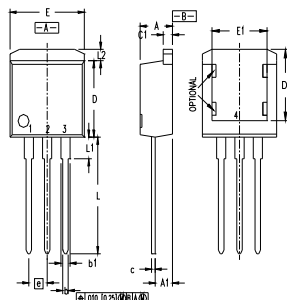

NOTE: This drawing will meet all dimensions requirement of JEDEC outline TO-262 AA.

SYM	INCHES		MILLIMETERS	
	MIN	MAX	MIN	MAX
A	.160	.190	4.06	4.83
A1	.080	.110	2.03	2.79
b	.025	.039	0.51	0.99
b2	.025	.039	1.14	1.40
c	.018	.029	0.46	0.74
c2	.018	.029	1.14	1.40
D	.340	.380	8.64	9.65
D1	.315	.350	8.00	8.89
E	.380	.405	9.65	10.29
E1	.245	.320	6.22	8.13
e	.100 BSC		2.54 BSC	
L	.500	.580	14.61	15.88
L1	.080	.130	2.29	2.79
L2	.040	.055	1.02	1.40

**Fig. 1. Output Characteristics
@ 25°C**

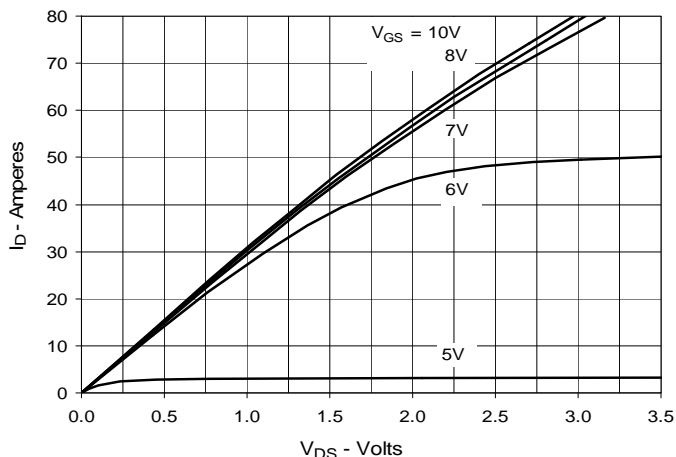

**Fig. 2. Extended Output Characteristics
@ 25°C**

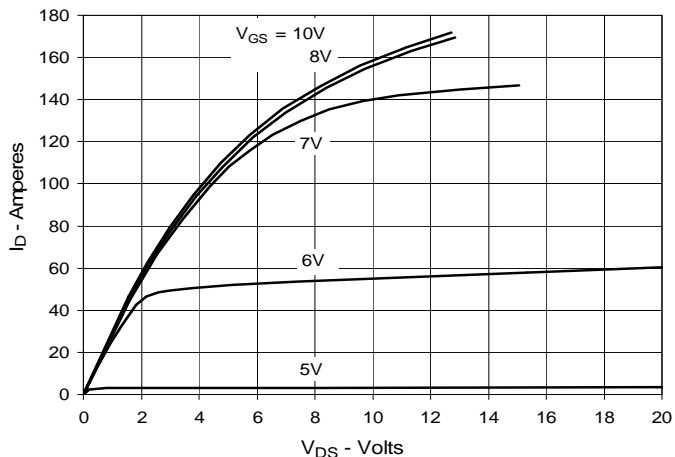

**Fig. 3. Output Characteristics
@ 125°C**

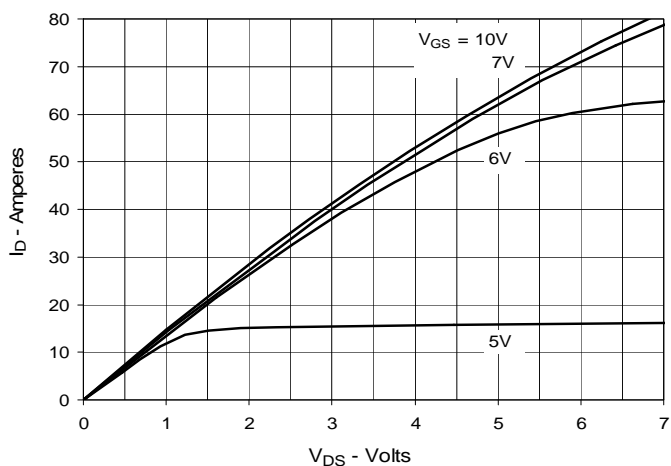

**Fig. 4. $R_{DS(on)}$ Normalized to $I_D = 38A$ Value
vs. Junction Temperature**

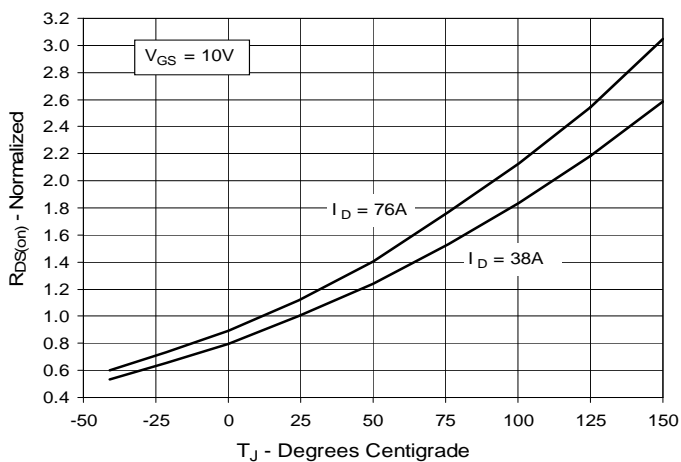

**Fig. 5. $R_{DS(on)}$ Normalized to $I_D = 38A$ Value
vs. Drain Current**

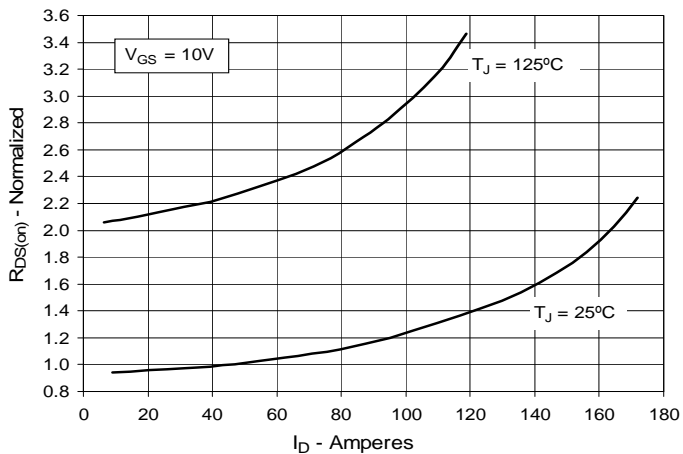

Fig. 6. Drain Current vs. Case Temperature

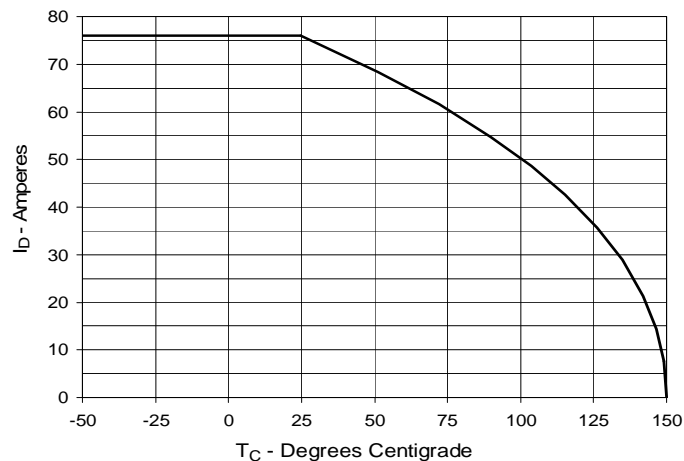

Fig. 7. Input Admittance

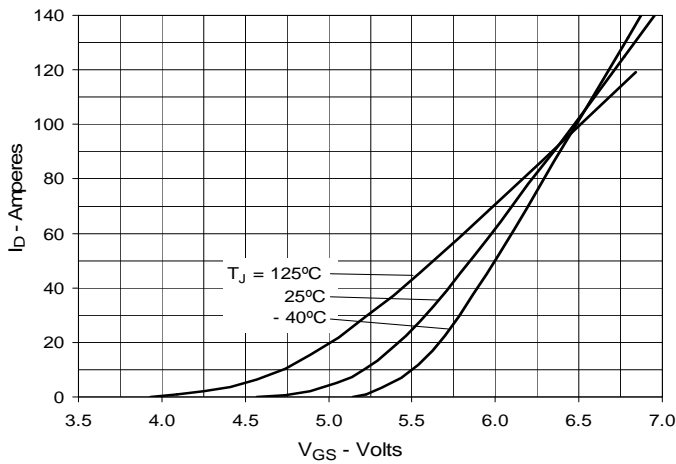

Fig. 8. Transconductance

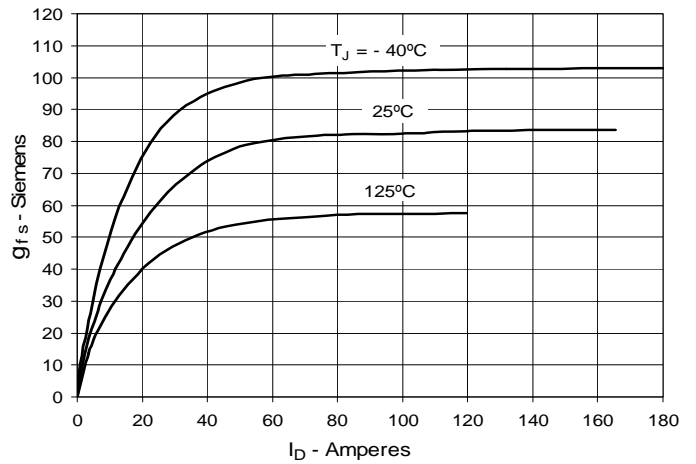

Fig. 9. Forward Voltage Drop of Intrinsic Diode

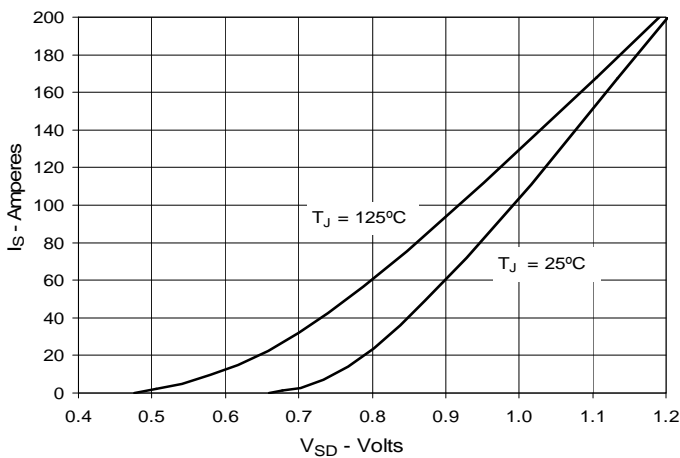

Fig. 10. Gate Charge

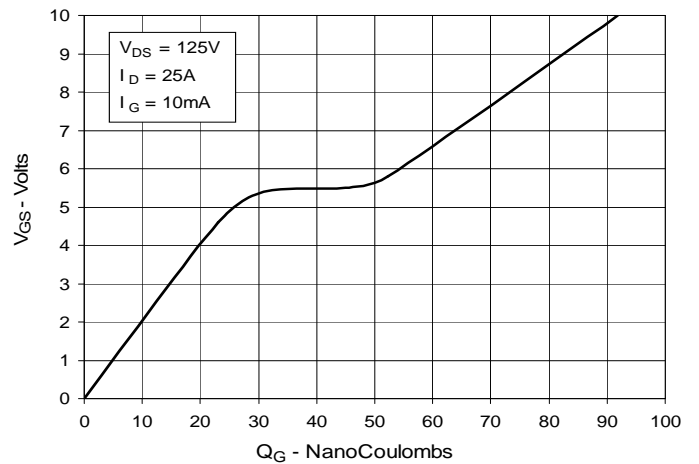

Fig. 11. Capacitance

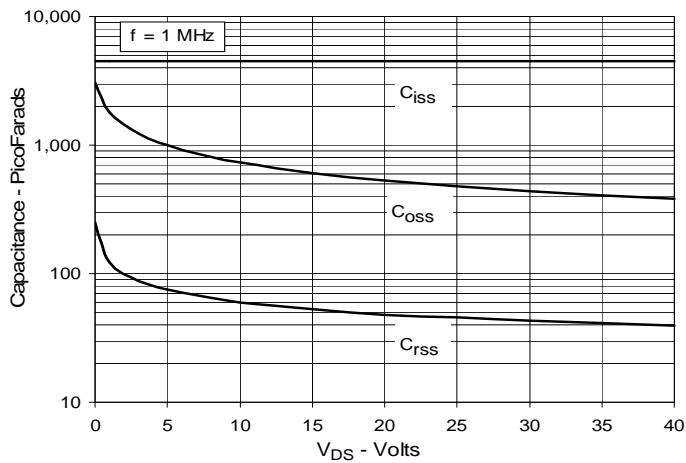

Fig. 12. Maximum Transient Thermal Impedance

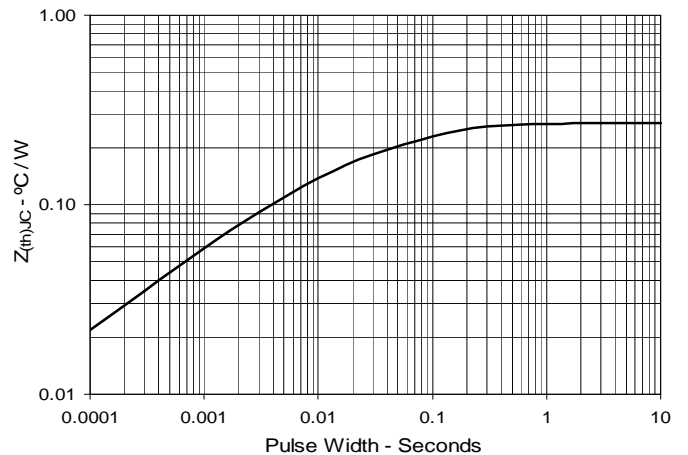

Fig. 13. Resistive Turn-on Rise Time vs. Junction Temperature

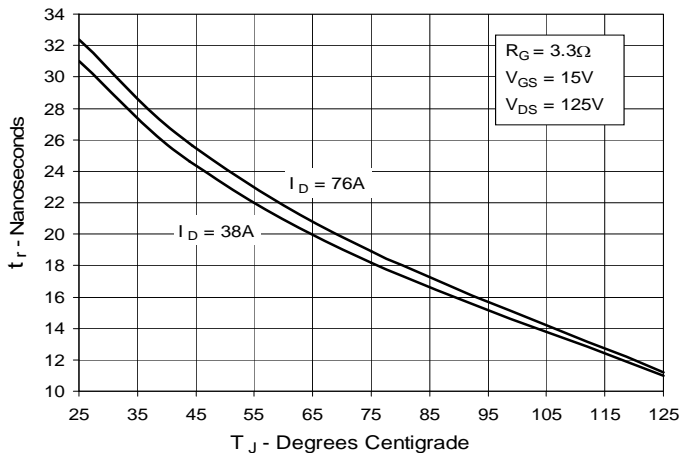

Fig. 14. Resistive Turn-on Rise Time vs. Drain Current

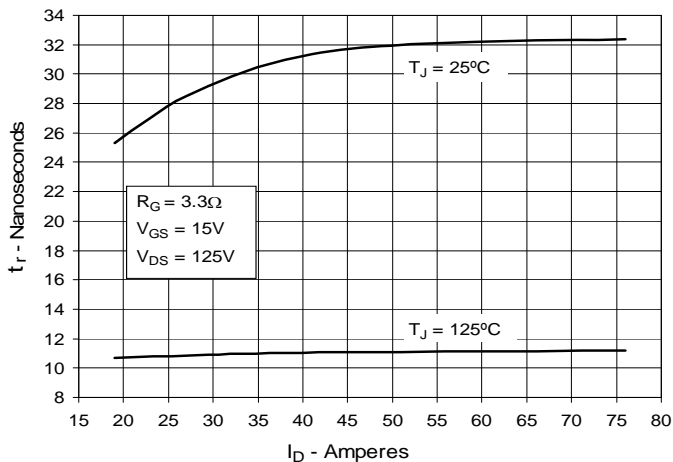

Fig. 15. Resistive Turn-on Switching Times vs. Gate Resistance

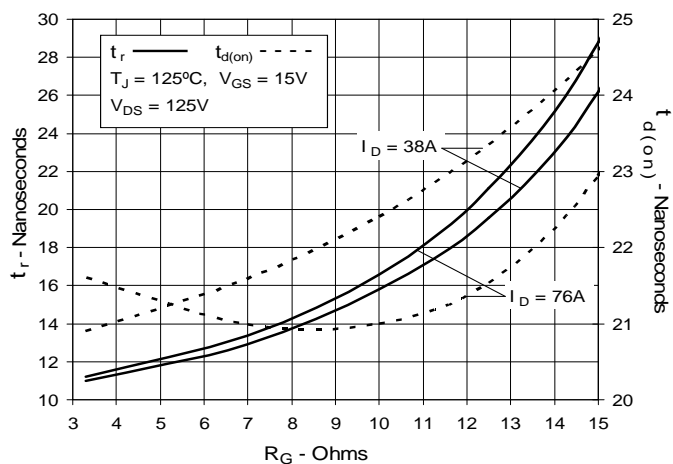

Fig. 16. Resistive Turn-off Switching Times vs. Junction Temperature

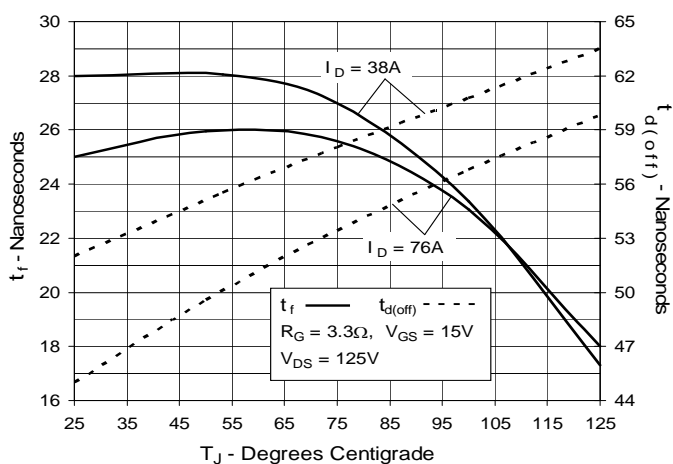

Fig. 17. Resistive Turn-off Switching Times vs. Drain Current

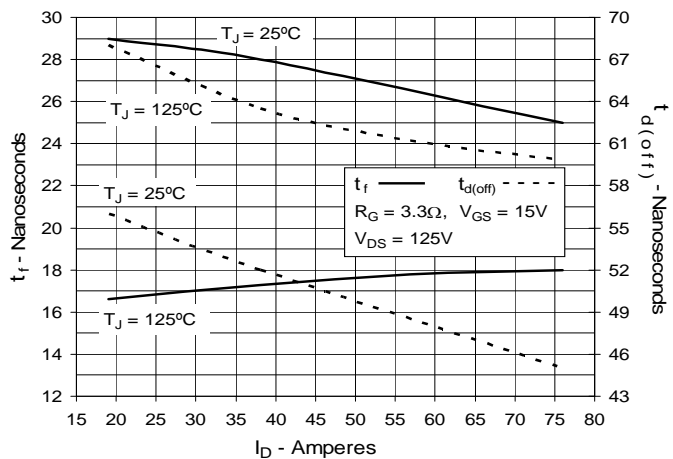
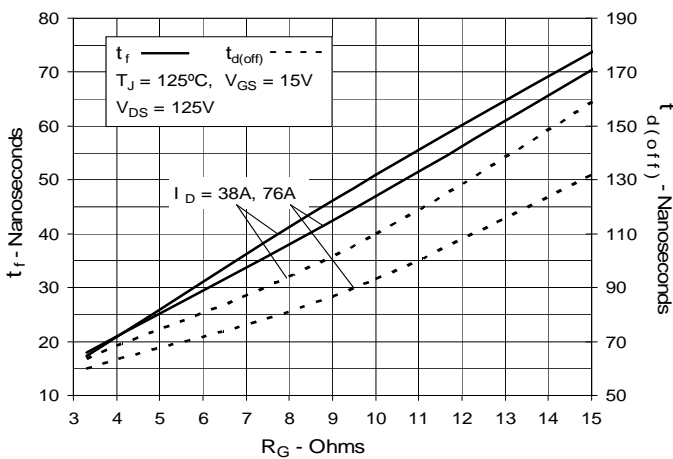

Fig. 18. Resistive Turn-off Switching Times vs. Gate Resistance



IXYS reserves the right to change limits, test conditions, and dimensions.