

## Rectifier Diode Modules



**V<sub>RRM</sub>** 800 to 1800V

**I<sub>FAV</sub>** 600 A

### Applications

- Non-controllable rectifiers for AC/AC converters
- Line rectifiers for transistorized AC motor controllers
- Field supply for DC motors

### Features

- Blocking voltage: 800 to 1800V
- Heat transfer through aluminum oxide ceramic isolated metal baseplate

### Circuit

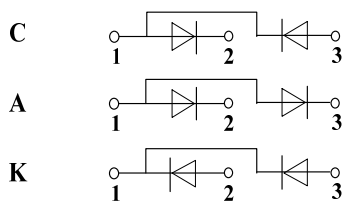

### Module Type

TYPE			V <sub>RRM</sub>	V <sub>RSM</sub>
MD600C08D5	MD600A08D5	MD600K08D5	800V	900V
MD600C12D5	MD600A12D5	MD600K12D5	1200V	1300V
MD600C16D5	MD600A16D5	MD600K16D5	1600V	1700V
MD600C18D5	MD600A18D5	MD600K18D5	1800V	1900V

### Maximum Ratings

Symbol	Conditions	Values	Units
I <sub>FAV</sub>	Single phase ,half wave 180° conduction T <sub>c</sub> =85°C	600	A
I <sub>FSM</sub>	t=10mS T <sub>vj</sub> =45°C	22000	A
i <sup>2</sup> t	t=10mS T <sub>vj</sub> =45°C	2420000	A <sup>2</sup> s
V <sub>isol</sub>	a.c.50HZ;r.m.s.;1min	3000	V
T <sub>vj</sub>		-40 to 150	°C
T <sub>stg</sub>		-40 to 125	°C
M <sub>t</sub>	To terminals(M10)	9±15%	Nm
M <sub>s</sub>	To heatsink(M6)	5±15%	Nm
Weight	Module (Approximately)	2050	g

### Thermal Characteristics

Symbol	Conditions	Values	Units
R <sub>th(j-c)</sub>	Per diode	0.04	°C/W
R <sub>th(c-s)</sub>	Module	0.015	°C/W

### Electrical Characteristics

Symbol	Conditions	Values			Units
		Min.	Typ.	Max.	
V <sub>FM</sub>	T=25°C I <sub>F</sub> =1800A	—	—	1.8	V
I <sub>RD</sub>	T <sub>vj</sub> =T <sub>vjM</sub> V <sub>RD</sub> =V <sub>RRM</sub>	—	—	25	mA

## Package Outline Information

CASE: D5

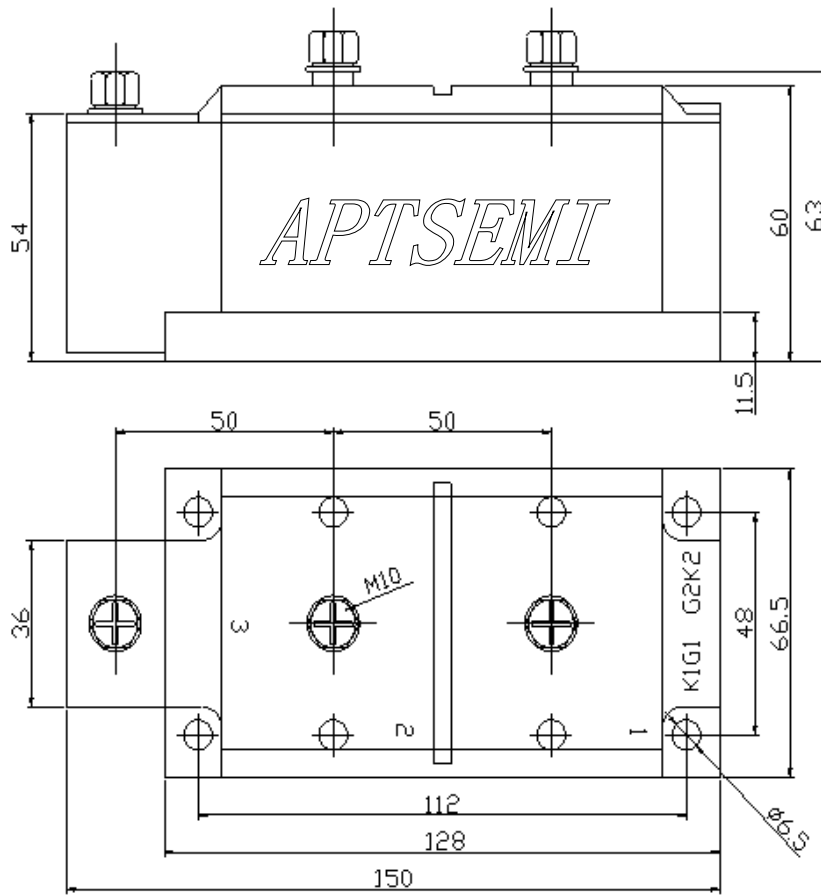

Dimensions in mm