

# ZXTN19055DZ

## 55V, SOT89, NPN medium power transistor

### Summary

$BV_{CEX} > 150V$   
 $BV_{CEO} > 55V$   
 $I_{C(cont)} = 6A$   
 $V_{CE(sat)} < 60mV @ 1A$   
 $R_{CE(sat)} = 28m\Omega$   
 $P_D = 2.1W$

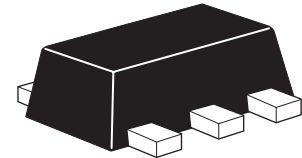

### Description

Packaged in the SOT89 outline this low saturation 55V NPN transistor offers extremely low on state losses making it ideal for use in DC-DC circuits and various driving and power management functions.

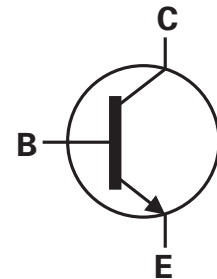

### Feature

- Extremely low equivalent on-resistance of 28mΩ
- 6 Amps continuous current
- Up to 10 amps peak current
- Very low saturation voltages
- Excellent  $h_{FE}$  characteristics up to 10 amps
- 150V Forward blocking voltage

### Applications

- Emergency lighting circuits
- Motor driving (including DC fans)
- Solenoid, relay and actuator drivers
- DC modules
- Backlight inverters

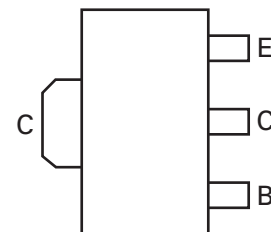

Pinout - top view

### Ordering information

Device	Reel size (inches)	Tape width (mm)	Quantity per reel
ZXTN19055DZTA	7	12	1000

### Device marking

S75

# ZXTN19055DZ

## Absolute maximum ratings

Parameter	Symbol	Limit	Unit
Collector-base voltage	$V_{CBO}$	150	V
Collector-emitter voltage (forward blocking voltage)	$V_{CEX}$	150	V
Collector-emitter voltage (base open)	$V_{CEO}$	55	V
Emitter-base voltage	$V_{EBO}$	7	V
Continuous collector current <sup>(b)</sup>	$I_C$	6	A
Peak pulse current	$I_{CM}$	10	A
Power dissipation at $T_{amb} = 25^\circ\text{C}^{(a)}$	$P_D$	1.5	W
Linear derating factor		12	mW/°C
Power dissipation at $T_{amb} = 25^\circ\text{C}^{(b)}$	$P_D$	2.1	W
Linear derating factor		16.8	mW/°C
Operating and storage temperature range	$T_j, T_{stg}$	-55 to +150	°C

## Thermal resistance

Parameter	Symbol	Limit	Unit
Junction to ambient <sup>(a)</sup>	$R_{\theta JA}$	83	°C/W
Junction to ambient <sup>(b)</sup>	$R_{\theta JA}$	59	°C/W

### NOTES:

(a) For a device surface mounted on 25mm x 25mm x 1.6mm FR4 PCB with high coverage of single sided 1oz copper, in still air conditions.

(b) For a device surface mounted on 50mm x 50mm x 1.6mm FR4 PCB with high coverage of single sided 1oz copper, in still air conditions.

## Characteristics

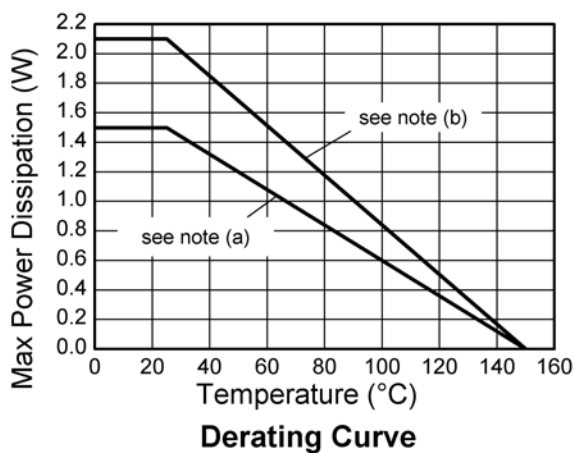
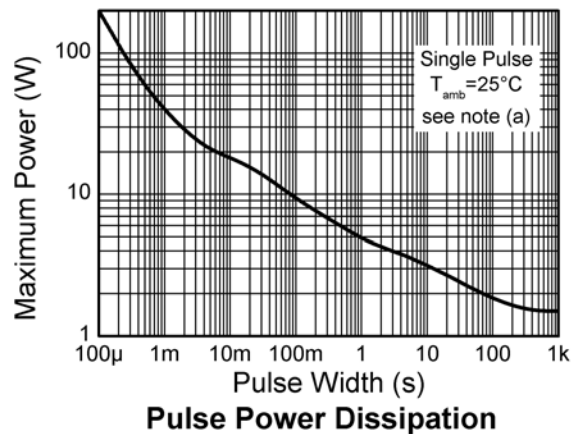
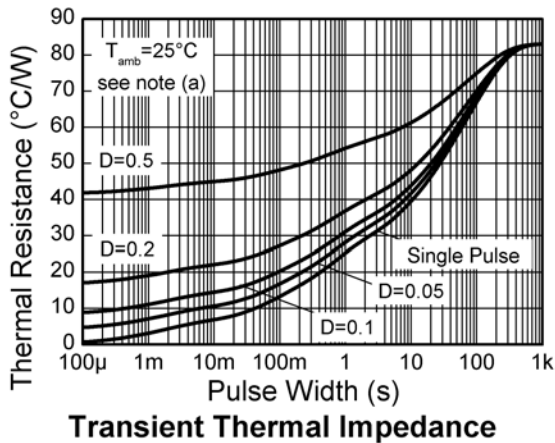
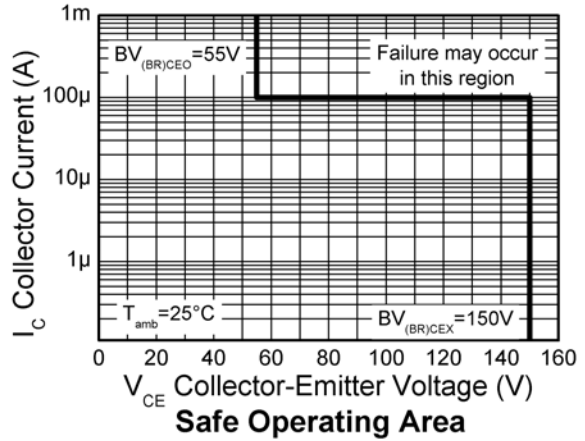
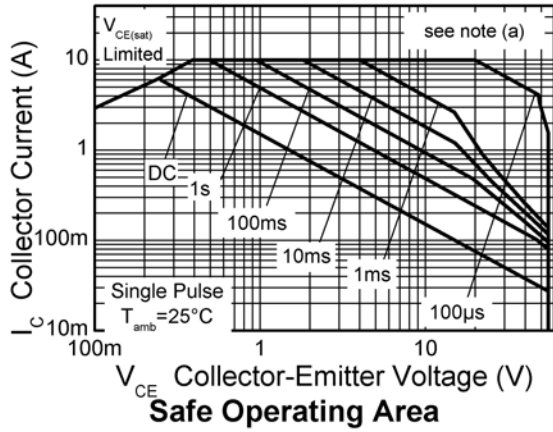

# ZXTN19055DZ

## Electrical characteristics (at $T_{amb} = 25^{\circ}\text{C}$ unless otherwise stated)

Parameter	Symbol	Min.	Typ.	Max.	Unit	Conditions
Collector-base breakdown voltage	$BV_{CBO}$	150	200		V	$I_C = 100\text{mA}$
Collector-emitter breakdown voltage (forward blocking)	$BV_{CEX}$	150	200		V	$I_C = 100\text{mA}$ , $R_{BE} < 1\text{k}\Omega$ or $-1\text{V} < V_{BE} < +0.25\text{V}$
Collector-emitter breakdown voltage (base open)	$BV_{CEO}$	55	75		V	$I_C = 10\text{mA}^{(*)}$
Emitter-base breakdown voltage	$BV_{EBO}$	7	8.1		V	$I_E = 100\text{mA}$
Collector-base cut-off current	$I_{CBO}$		<1	50 20	nA $\mu\text{A}$	$V_{CB} = 120\text{V}$ $V_{CB} = 120\text{V}$ , $T_{amb} = 100^{\circ}\text{C}$
Collector-emitter cut-off current	$I_{CEX}$		<1	100	nA	$V_{CE} = 120\text{V}$ ; $R_{BE} < 1\text{k}\Omega$ or $-1\text{V} < V_{BE} < 0.25\text{V}$
Emitter cut-off current	$I_{EBO}$		<1	50	nA	$V_{EB} = 5.6\text{V}$
Collector-emitter saturation voltage	$V_{CE(sat)}$		25 45 40 200 110 140 170	40 70 60 350 140 200 250	mV mV mV mV mV mV mV	$I_C = 0.5\text{A}$ , $I_B = 50\text{mA}^{(*)}$ $I_C = 1\text{A}$ , $I_B = 50\text{mA}^{(*)}$ $I_C = 1\text{A}$ , $I_B = 100\text{mA}^{(*)}$ $I_C = 2\text{A}$ , $I_B = 20\text{mA}^{(*)}$ $I_C = 2\text{A}$ , $I_B = 40\text{mA}^{(*)}$ $I_C = 4\text{A}$ , $I_B = 200\text{mA}^{(*)}$ $I_C = 6\text{A}$ , $I_B = 600\text{mA}^{(*)}$
Base-emitter saturation voltage	$V_{BE(sat)}$		800 1000	900 1150	mV mV	$I_C = 2\text{A}$ , $I_B = 20\text{mA}^{(*)}$ $I_C = 6\text{A}$ , $I_B = 600\text{mA}^{(*)}$
Base-emitter turn-on voltage	$V_{BE(on)}$		760 900	900 1050	mV mV	$I_C = 2\text{A}$ , $V_{CE} = 2\text{V}^{(*)}$ $I_C = 6\text{A}$ , $V_{CE} = 2\text{V}^{(*)}$
Static forward current transfer ratio	$h_{FE}$	250 250 180 30	400 400 300 50 20	700		$I_C = 10\text{mA}$ , $V_{CE} = 2\text{V}^{(*)}$ $I_C = 1\text{A}$ , $V_{CE} = 2\text{V}^{(*)}$ $I_C = 2\text{A}$ , $V_{CE} = 2\text{V}^{(*)}$ $I_C = 6\text{A}$ , $V_{CE} = 2\text{V}^{(*)}$ $I_C = 10\text{A}$ , $V_{CE} = 2\text{V}^{(*)}$
Transition frequency	$f_T$	140	200		MHz	$I_C = 100\text{mA}$ , $V_{CE} = 10\text{V}$ $f = 50\text{MHz}$
Output capacitance	$C_{OBO}$		21.2	30	pF	$V_{CB} = 10\text{V}$ , $f = 1\text{MHz}$
Delay time	$t_d$		13.8			$V_{CC} = 10\text{V}$ ,
Rise time	$t_r$		21.9			$I_C = 1\text{A}$ ,
Storage time	$t_s$		546			$I_{B1} = I_{B2} = 100\text{mA}$
Fall time	$t_f$		106			

### NOTES:

(\*) Measured under pulsed conditions. Pulse width  $\leq 300\mu\text{s}$ ; duty cycle  $\leq 2\%$ .

## Typical characteristics

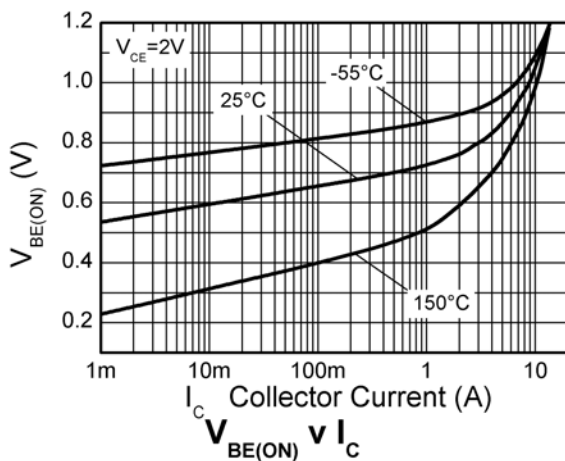
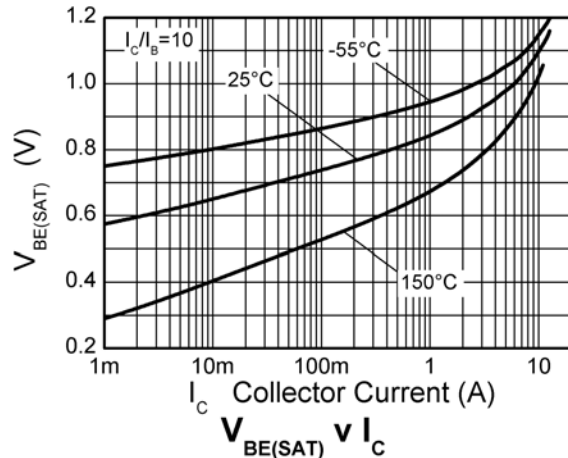
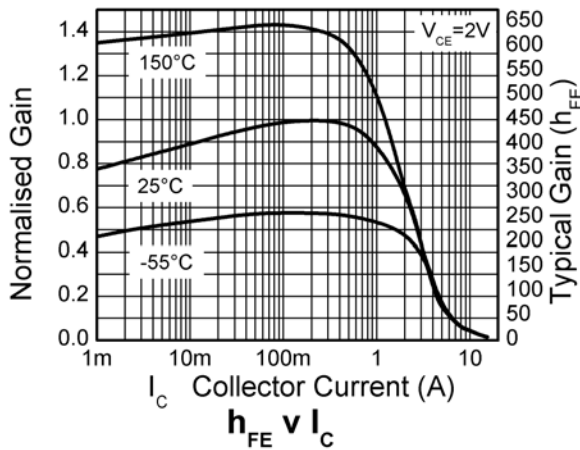
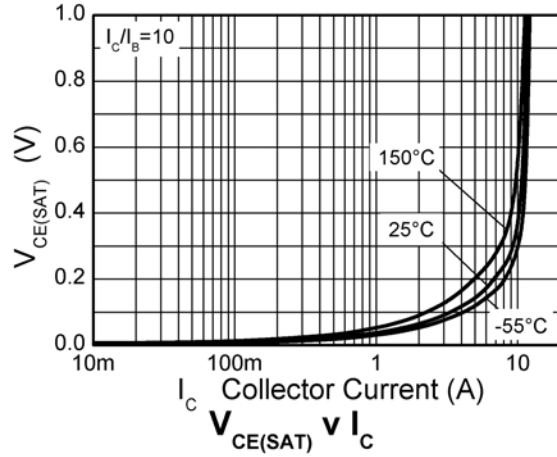
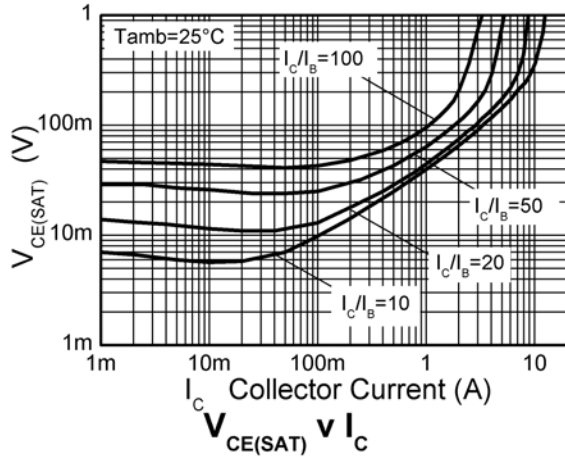

# ZXTN19055DZ

## Package outline - SOT89

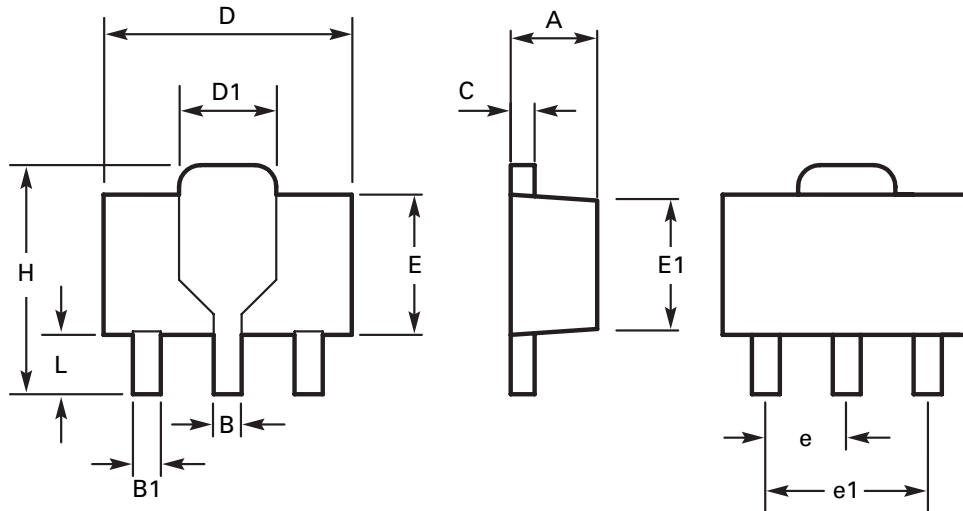

DIM	Millimeters		Inches		DIM	Millimeters		Inches	
	Min	Max	Min	Max		Min	Max	Min	Max
A	1.40	1.60	0.550	0.630	E1	2.13	2.29	0.084	0.090
B	0.44	0.56	0.017	0.022	e	1.50 BSC		0.059 BSC	
B1	0.36	0.48	0.014	0.019	e1	3.00 BSC		0.118 BSC	
C	0.35	0.44	0.014	0.019	H	3.94	4.25	0.155	0.167
D	4.40	4.60	0.173	0.181	L	0.89	1.20	0.155	0.167
E	2.29	2.60	0.090	0.102		-	-	-	-

**Note:** Controlling dimensions are in millimeters. Approximate dimensions are provided in inches

### Europe

Zetex GmbH  
Streitfeldstraße 19  
D-81673 München  
Germany

Telefon: (49) 89 45 49 49 0  
Fax: (49) 89 45 49 49 49  
europe.sales@zetex.com

### Americas

Zetex Inc  
700 Veterans Memorial Highway  
Hauppauge, NY 11788  
USA

Telephone: (1) 631 360 2222  
Fax: (1) 631 360 8222  
usa.sales@zetex.com

### Asia Pacific

Zetex (Asia Ltd)  
3701-04 Metroplaza Tower 1  
Hing Fong Road, Kwai Fong  
Hong Kong

Telephone: (852) 26100 611  
Fax: (852) 24250 494  
asia.sales@zetex.com

### Corporate Headquarters

Zetex Semiconductors plc  
Zetex Technology Park, Chadderton  
Oldham, OL9 9LL  
United Kingdom

Telephone: (44) 161 622 4444  
Fax: (44) 161 622 4446  
hq@zetex.com

For international sales offices visit [www.zetex.com/offices](http://www.zetex.com/offices)

Zetex products are distributed worldwide. For details, see [www.zetex.com/salesnetwork](http://www.zetex.com/salesnetwork)

This publication is issued to provide outline information only which (unless agreed by the company in writing) may not be used, applied or reproduced for any purpose or form part of any order or contact or be regarded as a representation relating to the products or services concerned. The company reserves the right to alter without notice the specification, design, price or conditions of supply of any product or service.