

DB201S THRU DB207S

List

List..... 1

Package outline..... 2

Features..... 2

Mechanical data..... 2

Maximum ratings 2

Rating and characteristic curves..... 3

Pinning information..... 4

Marking..... 4

Suggested solder pad layout..... 4

Packing information..... 5

Reel packing and tube packing..... 6

Suggested thermal profiles for soldering processes..... 6

High reliability test capabilities..... 7

深圳FMS Kinter 131 6803 0058

DB201S THRU DB207S

2.0A Miniature Glass Passivated Single-Phase Surface Mount Bridge Rectifiers-50-1000V

Features

- Surge overload ratings to 50 amperes peak.
- Save space on printed circuit board.
- Ideal for automated replacement.
- Reliable low cost construction utilizing molded plastic technology results in inexpensive product.
- Glass passivated chip junctions.
- Lead-free parts meet RoHS requirements.
- UL recognized file # E321971
- Suffix "-H" indicates Halogen free parts, ex. DB201S-H.

Mechanical data

- Epoxy:UL94-V0 rated flame retardant
- Case : Molded plastic, DBS
- Terminals : Solder plated, solderable per MIL-STD-750, Method 2026
- Polarity : marked on body
- Mounting Position : Any
- Weight : Approximated 0.50 gram

Package outline

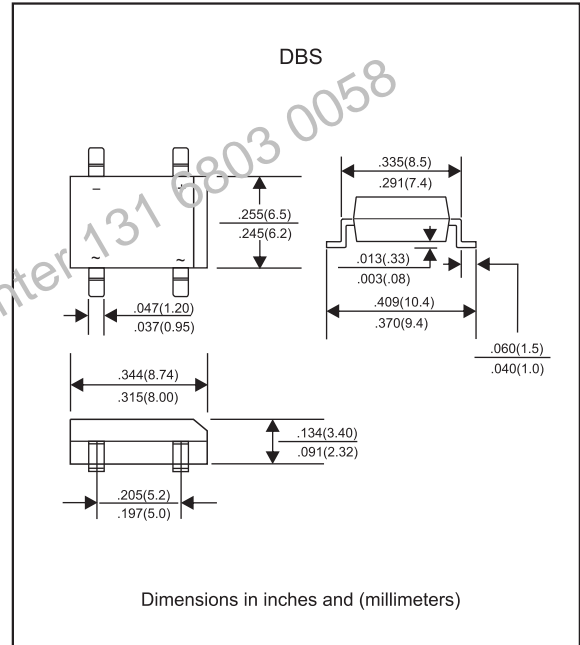

Maximum ratings and Electrical Characteristics (AT T_A=25°C unless otherwise noted)

PARAMETER	CONDITIONS	Symbol	MIN.	TYP.	MAX.	UNIT
Forward rectified current	See Fig.1	I _o			2.0	A
Forward surge current	8.3ms single half sine-wave superimposed on rate load (JEDEC methode)	I _{FSM}			50	A
Reverse current	V _R = V _{RRM} T _J = 25°C	I _R			10	uA
	V _R = V _{RRM} T _J = 125°C				500	
Diode junction capacitance	f=1MHz and applied 4V DC reverse voltage	C _J		25		pF
Storage temperature		T _{STG}	-65		+175	°C

SYMBOLS	V _{RRM} ^{*1} (V)	V _{RMS} ^{*2} (V)	V _R ^{*3} (V)	V _F ^{*4} (V)	Operating temperature T _J (°C)
DB201S	50	35	50	1.10	-55 to +150
DB202S	100	70	100		
DB203S	200	140	200		
DB204S	400	280	400		
DB205S	600	420	600		
DB206S	800	560	800		
DB207S	1000	700	1000		

- *1 Repetitive peak reverse voltage
- *2 RMS voltage
- *3 Continuous reverse voltage
- *4 Maximum forward voltage@I_F=2.0A

Rating and characteristic curves (DB201S THRU DB207S)

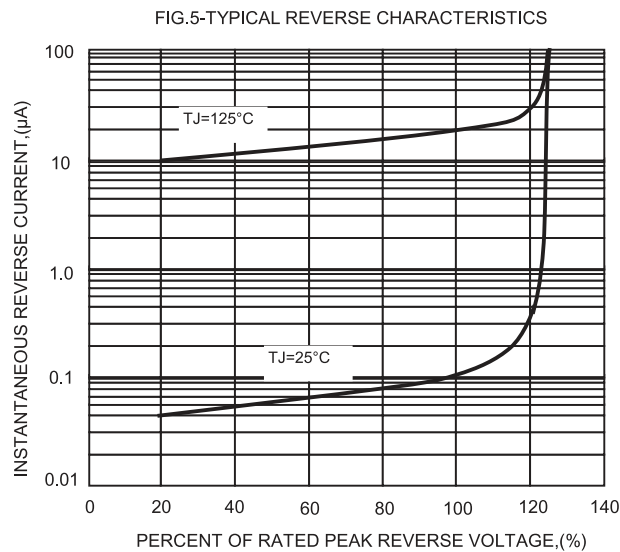
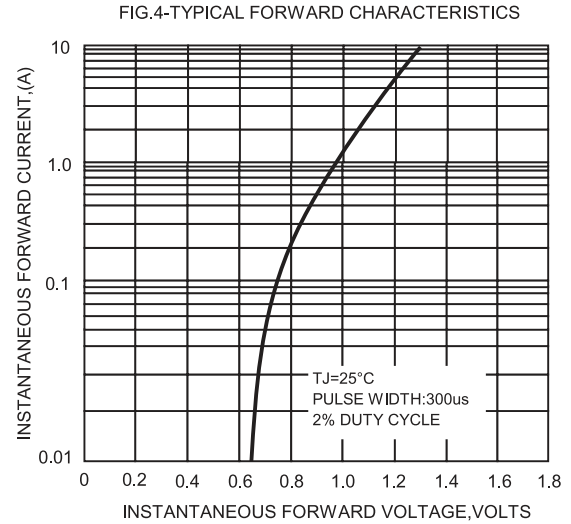
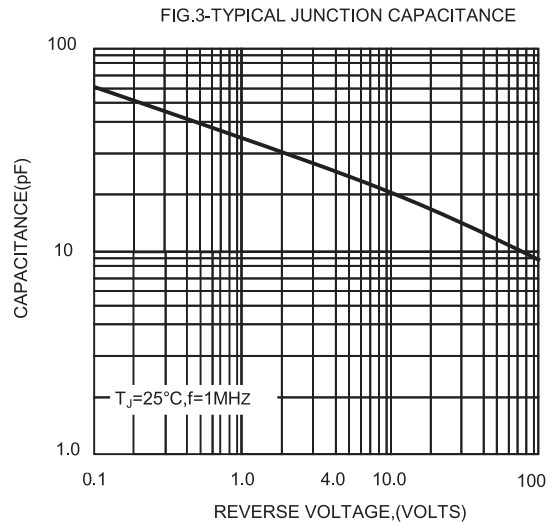
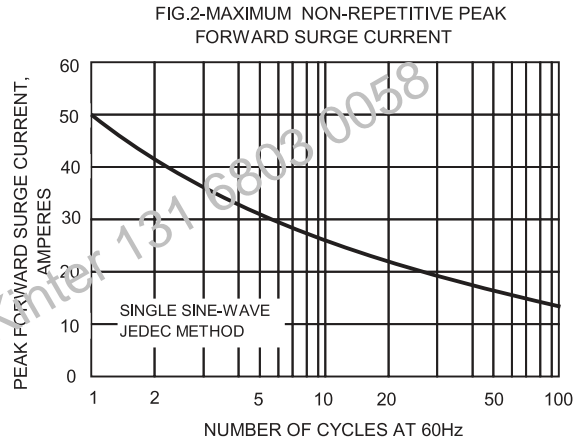
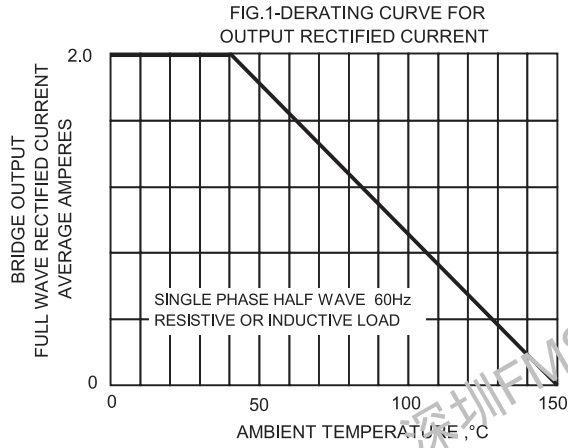

DB201S THRU DB207S

Pinning information

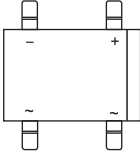
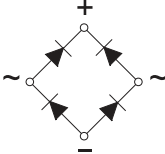
Simplified outline	Symbol
	

Marking

Type number	Marking code
DB201S	DB201S
DB202S	DB202S
DB203S	DB203S
DB204S	DB204S
DB205S	DB205S
DB206S	DB206S
DB207S	DB207S

Suggested solder pad layout

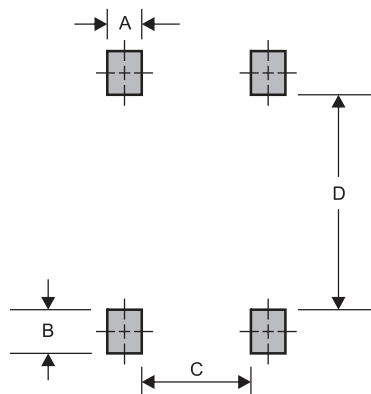

Dimensions in inches and (millimeters)

PACKAGE	A	B	C	D
DBS	0.059 (1.50)	0.047 (1.20)	0.157 (4.00)	0.291 (7.40)

DB201S THRU DB207S

Packing information

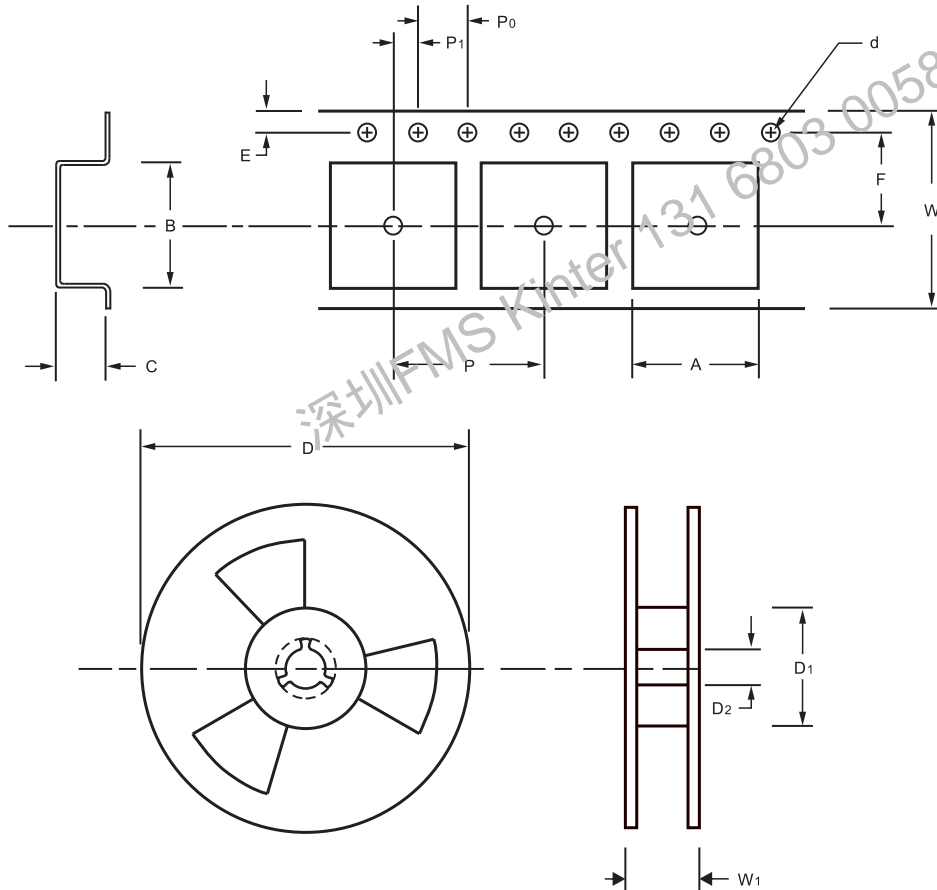

unit:mm

Item	Symbol	Tolerance	DBS
Carrier width	A	0.1	8.64
Carrier length	B	0.1	10.41
Carrier depth	C	0.1	3.50
Sprocket hole	d	0.1	1.50
13" Reel outside diameter	D	2.0	330.00
13" Reel inner diameter	D ₁	min	50.00
7" Reel outside diameter	D	2.0	-
7" Reel inner diameter	D ₁	min	-
Feed hole diameter	D ₂	0.5	13.00
Sprocket hole position	E	0.1	1.75
Punch hole position	F	0.1	7.50
Punch hole pitch	P	0.1	12.00
Sprocket hole pitch	P ₀	0.1	4.00
Embossment center	P ₁	0.1	2.00
Overall tape thickness	T	0.1	0.30
Tape width	W	0.3	16.00
Reel width	W ₁	1.0	22.00

Note: Devices are packed in accordance with EIA standard RS-481-A and specifications listed above.

DB201S THRU DB207S

Reel packing and tube packing

PACKAGE	REEL SIZE	REEL (pcs)	COMPONENT SPACING (m/m)	BOX (pcs)	INNER BOX (m/m)	REEL DIA, (m/m)	CARTON SIZE (m/m)	CARTON (pcs)	APPROX. GROSS WEIGHT (kg)
DBS	13"	1000	12.0	2000	337*337*37	330	350*330*360	12,000	12.0

PACKAGE	TUBE (pcs)	TUBE SIZE (m/m)	BOX (pcs)	INNER BOX (m/m)	CARTON SIZE (m/m)	CARTON (pcs)	APPROX. GROSS WEIGHT (kg)
DBS	50	452*13.9*5.8	5000	450*145*73	470*240*310	30,000	21.0

Suggested thermal profiles for soldering processes

- 1.Storage environment: Temperature=-5°C~40°C Humidity=55%±25%
- 2.Reflow soldering of surface-mount devices

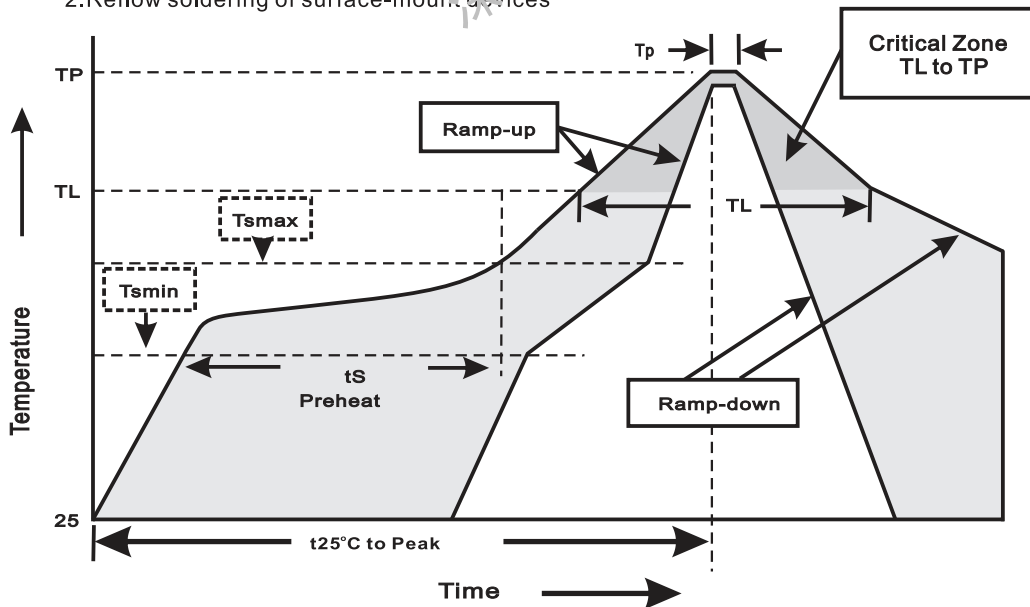

3.Reflow soldering

Profile Feature	Soldering Condition
Average ramp-up rate(TL to TP)	<3°C/sec
Preheat -Temperature Min(Tsmin) -Temperature Max(Tsmax) -Time(min to max)(ts)	150°C 200°C 60~120sec
Tsmax to TL -Ramp-upRate	<3°C/sec
Time maintained above: -Temperature(TL) -Time(tL)	217°C 60~260sec
Peak Temperature(TP)	255°C-0/+5°C
Time within 5°C of actual Peak Temperature(tp)	10~30sec
Ramp-down Rate	<6°C/sec
Time 25°C to Peak Temperature	<6minutes

DB201S THRU DB207S**High reliability test capabilities**

Item Test	Conditions	Reference
1. Solder Resistance	at 260±5°C for 10±2sec. immerse body into solder 1/16"±1/32"	MIL-STD-750D METHOD-2031
2. Solderability	at 245±5°C for 5 sec.	MIL-STD-202F METHOD-208
3. High Temperature Reverse Bias	$V_R=80\%$ rate at $T_J=150^\circ\text{C}$ for 168 hrs.	MIL-STD-750D METHOD-1038
4. Forward Operation Life	Rated average rectifier current at $T_A=25^\circ\text{C}$ for 500hrs.	MIL-STD-750D METHOD-1027
5. Intermittent Operation Life	$T_A=25^\circ\text{C}$, $I_F=I_O$ On state: power on for 5 min. off state: power off for 5 min. on and off for 500 cycles.	MIL-STD-750D METHOD-1036
6. Pressure Cooker	$15P_{SIG}$ at $T_A=121^\circ\text{C}$ for 4 hrs.	JESD22-A102
7. Temperature Cycling	-55°C to +125°C dwelled for 30 min. and transferred for 5min. total 10 cycles.	MIL-STD-750D METHOD-1051
8. Thermal Shock	0°C for 5 min. rise to 100°C for 5 min. total 10 cycles.	MIL-STD-750D METHOD-1056
9. Forward Surge	8.3ms single half sine-wave superimposed on rated load, one surge.	MIL-STD-750D METHOD-4066-2
10. Humidity	at $T_A=85^\circ\text{C}$, RH=85% for 1000hrs.	MIL-STD-750D METHOD-1021
11. High Temperature Storage Life	at 175°C for 1000 hrs.	MIL-STD-750D METHOD-1031