

The "DirectEtch" Technique

PCB

FAB -IN-A- BOX



Flexible PCB

INTRO:

[START HERE](#)

[PRODUCTS](#)

[ACCESSORIES](#)

DETAILS:

[DIRECT ETCH](#)

[SURFACE MOUNT](#)

[GOING FARTHER](#)

SUPPORT:

[WHAT'S NEW!](#)

[TECH SUPPORT](#)

[LIBRARY](#)

[WEB LINKS](#)

OTHER:

[CONTACT US](#)

[HUMOR](#)

[OTHER PRODUCTS](#)

[Shop Now](#)

Keypads, Pigtails & PCB's

PCB FAB -IN-A-BOX

FlexPCB

DOUBLE-Sided

Keypads, Pigtails & PCB's

PCB FAB -IN-A-BOX

FlexPCB

SINGLE-Sided

RATING: **G10/FR4**

MATERIAL: **FIBERGLASS**

QUANTITY: **2 PANELS**

THICKNESS: **.005"**

PANEL SIZE: **8"x10"**

COPPER WT: **1/2oz**

Contents: Two 8"x10" panels plus a Carrier Board as a rigid base for passing flex through the Toner Image Applicator. Laminate is constructed of 1-ply fiberglass bonded to 1/2oz copper. Cuts with scissors. See our website at "www.PCBfx.com" for user support, connectors, tips and tricks.

Laminated Sheet Properties		per NEMA based on .500 sheet	
Minimum Breakdown Voltage:	Condition A	45,000	
Maximum Permittivity @ 1MHz:	Condition A	5.200	
Maximum Dielectric Factor @ 1MHz:	Condition A	0.025	
Minimum Bonding Strength:	Condition A	2000.000	
Minimum Water Absorption:		0.10%	
Minimum Tensile Strength:	Lengthwise	7,000	
	Crosswise	5,500	
Minimum Flexural Strength:	Lengthwise	45,000	
	Crosswise	35,000	

Contents: Two 8"x10" panels plus a Carrier Board as a rigid base for passing flex through the Toner Image Applicator. Laminate is constructed of 1-ply fiberglass bonded to 1/2oz copper. Cuts with scissors. See our website at "www.PCBfx.com" for user support, connectors, tips and tricks.

Pulsar PROFESSIONAL fx

5822 Roy Heights, Colorado Springs, CO 80915-1593
www.PulsarProFX.com / mail@pulsarprofx.com
PHONE: (850) 926-2009 FAX: (888) 280-7570

FlexPCB (3x)

5821001524

Made in U.S.A. / Tech Support in U.S.A.

Freedom to...

- *Wrap Your Next PCB Around Corners*
- *Make Flat Ribbon Board-to-Board Interconnects*
- *Design Custom Membrane Keypads*

Highly flexible laminate is a mere .005" thick using 1-ply of fiberglass under the G10/FR4 spec with 1/2oz copper.

It will allow you to make the same high quality PCB's you are used to making with our .032" rigid laminate allowing for extremely fine trace pitch with etch times down to a minute (using our "Contact Etch" technique).

Kit contains **two** 8" x 10" panels of either **Single** or **Double**-sided copper and a .020" fiberglass "Carrier Board", used to transport small pieces of cut laminate through the TIA Applicator preventing wrinkle). You can, of course, use any household iron to transfer your circuit pattern if you prefer but it's highly recommended that you first calibrate the iron. See "Tech Support" button for

"How To".

Even though this laminate is only .005" (the thickness of an ordinary sheet of printer paper) it has a level of rigidity that allows for mounting through-hole or SMT discrete components with ease anywhere along the flex board and of course, the laminate cuts with scissors.

Single-Sided • Double-Sided

Let's start with a little background on this really neat laminate. There are two types of "flex"... Polyimide & Fiberglass

POLYIMIDE (pronounced Poly 'IM id or just by the two letters PI) is the type you are most used to seeing with its typical golden brown color. This conventional type of flexible film is generically referred to as Kapton or PyraLux (trade names of Dupont).

FIBERGLASS based flex is the alternative to the very expensive polyimide or "PI" laminate. Our flex is built on just 1-ply fiberglass to enable it to be just as flexible as PI films. Fiberglass based flex is rarely seen in commercially made products for some unknown reason.

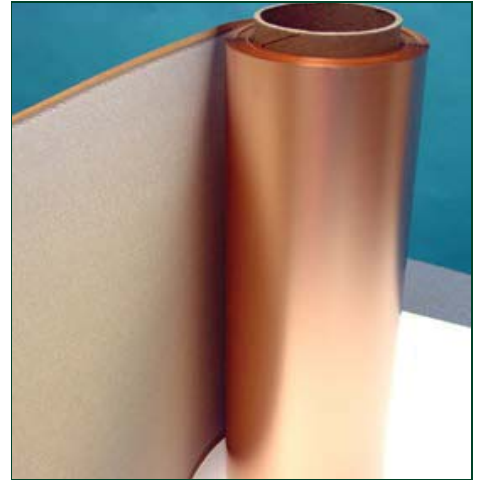

Disadvantages and Drawbacks? Well, yes... they both have a few!

The #1 drawback of using polyimide-based flex in a design you are wanting to do is flat-out availability! The #2 drawback is COST!

Polyimide film has a ton of parameters to contend with... there is the Type of polyimide base to select to which there are 4, Thickness of the film (8), Adhesive (3) and finally, Weight of the copper foil (6). That's a lot to have to deal with. Sure, you could contact Dupont or Insulectro (distributor) to obtain samples but you have to go through a lot to setup an account, etc, etc, but what then? There is no 're-supply' on samples and you can quickly over-stay your welcome! And yes, we could have offered one specific type of polyimide type board for "general" use as we have done with our rigid board, but we still couldn't get around the second most important drawback of using this type of flex board... COST! Polyimide film is about 6 times more expensive over the alternative of going with 1-ply fiberglass. Is it just as good? Well, in light of just a tad bit of compromise, we feel that's answered with a definite yes!

There is even a third disadvantage to using polyimide film;

...mounting discrete components! When components are to be mounted on PI film you normally need to add what's called a "stiffener" in the area around the components to prevent copper foil cracking or delaminating. It's a second layer of a prescribed pad thickness laminated under the film. All in all, it's just a much harder product to consider working with for anything short of commercial, high-end mass production. And since we cater directly to everyone OTHER than that, it just doesn't make sense to offer expensive Polyimide as the flex board material of choice.

Ok, so we've put the 'kabash' on polyimide pretty hard here. So what's the disadvantage of using OUR 1-ply fiberglass?

All things being equal, there really is only one problem using 1-ply fiberglass. It tends to "snap"

(ie. crack!) when folded hard over and CREASED flat! But don't despair, there is a very simple fix to this problem inherent to fiberglass as being brittle.

If your design needs to turn a hard 90° or flip over itself 180° (as in this simple keyboard example on the right) 1-ply fiberglass will crack in half. Surprise! Notice in the example on the right, the artwork is setup to have a hard 180° creased fold-over bend in the middle. Well, if that is done and the board cracks, the only thing holding the two "pieces" together are the 4 circuit traces and that isn't very stable.

Here's the fix! Reference the modified image on the left. By merely placing a small rectangular area of blank copper over the fold line to be creased flat we can now retain full integrity of the finished board. The traces going across this crease line lend their assistance too.

4x4 Matrix Keypad for Single-Sided Flex

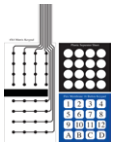
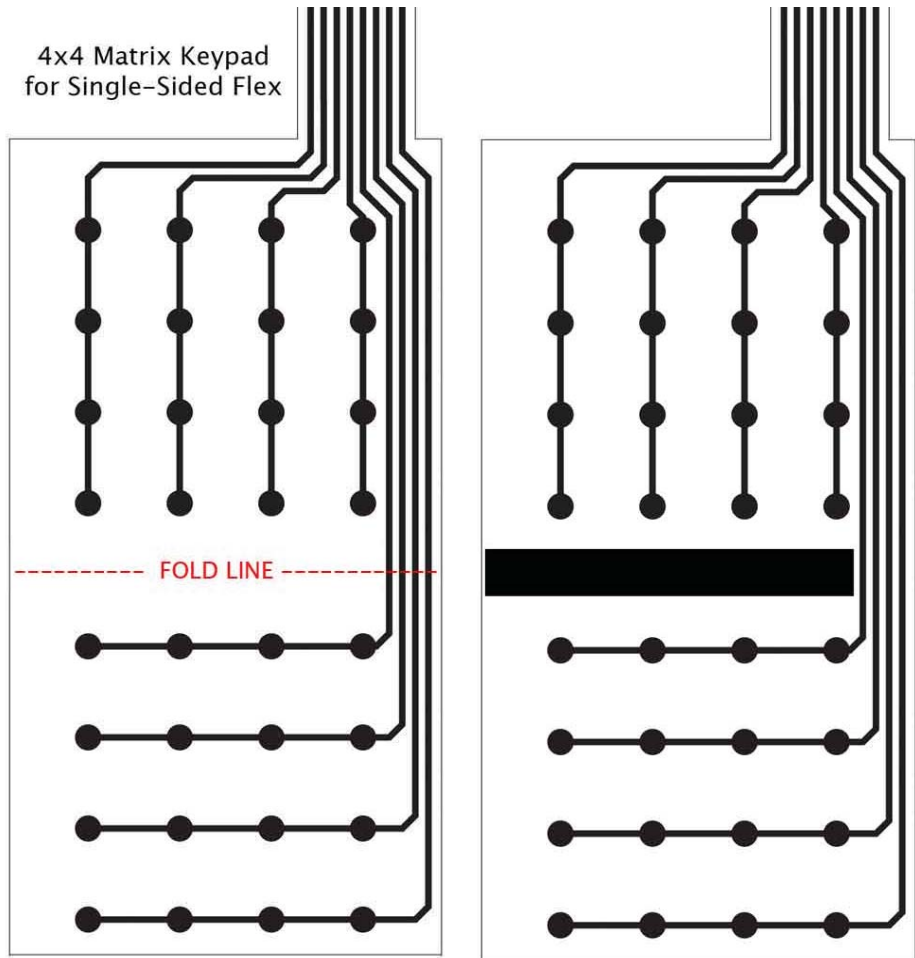

Here is the full-size artwork with graphics and "spacer" overlays.

Flex membrane keypads can be made using this layout, folding it in half with a simple "spacer" made out of a piece of "Overhead Transparency" acetate which gives very fast response times, or you can add tactile feedback with "domes" placed over each key described a little farther down the page.

Next up... "ACCESSORIZE!"

The FlexPCB is going to be a little naked unless we can make some connections very easily. We'll discuss two items... Connectors and Domes for keypads.



Pigtail Connectors:

The tail end of your flex board's connection is generally done one of two ways.

One way is to leave the tail end alone and just push it into a PCB mounted connector as shown below in the "Termination Types". Here

is DigiKey's main listing of [Board Mount connectors](#). The two main manufacturers of all PCB connectors

for flex-type laminates are [FCI](#) and [TE Connectivity](#).

Termination type (Through Hole & SMT)

THROUGH HOLE

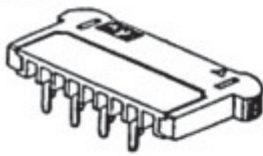

Right Angle

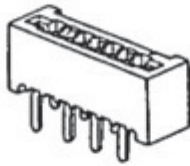

Straight

SURFACE MOUNT

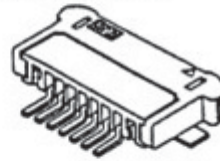

Right Angle

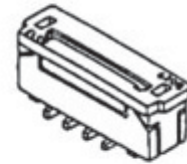

Straight

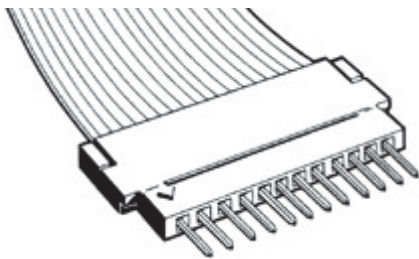

The other method is to add a male or female "crimp" style connector. These have piercing "crimps" that pierce through the flex laminate to make a very good connection to the copper trace.

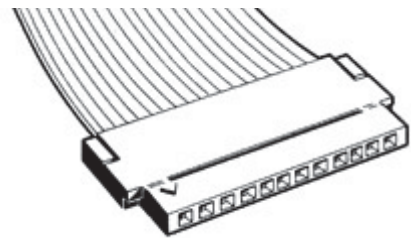

These connectors are referred to as "FFC / FPC" for **Flat Flex Connector** or **Flexible Printed Circuit**. (Great search terms for more info)

These two photos show how the crimp type connectors look before use. This particular style is called "Clincher" made by FCI (a major connector mfg). This kind of connector mated to the end of a flex pigtail is called a "Free Hanging" connector, as opposed to a "Board Mount" connector (described in section above) where the bare pigtail is pushed into the soldered connector on the PCB.



There is a lot to choose from. These two blue units above happen to be 8 conductor connectors from DigiKey, part number 609-2164-ND (male) and 609-2182-ND (female).

[DigiKey](#) carries a mesmerizing array of connectors referred to as "FFC / FPC" for **Flat Flex Connector and/or Flexible Printed Circuit**. (Great search terms for more info)

Keypad "Click" Domes:

One of the leaders of "keypad domes" is a company by the name of [SnapTron.com](#) and here is their [Design Guide](#).

One of their pre-made designs has a hole in the middle of the dome to allow an

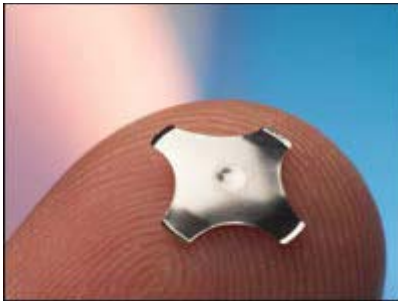

LED to light up through the button!
This gives the

designer some very very cool visual effects possible.

There's no secret to making flex keyboards. It's a very simple process allowing you to let your creativity flow for very uniquely shaped keypads, never having to accept boring pre-made keypads ever again. All you're basically doing is spray gluing a few layers together and you have a flush, surface enclosure mounted keypad with the tail tucked under the keypad and into the enclosure. Also to reduce the number of "X" & "Y" contact points, we generally want to use one of the common keyboard encoder chips, like the 74C922 to easily handle up to 16 keys with a BCD output for minimal microprocessor pin usage.

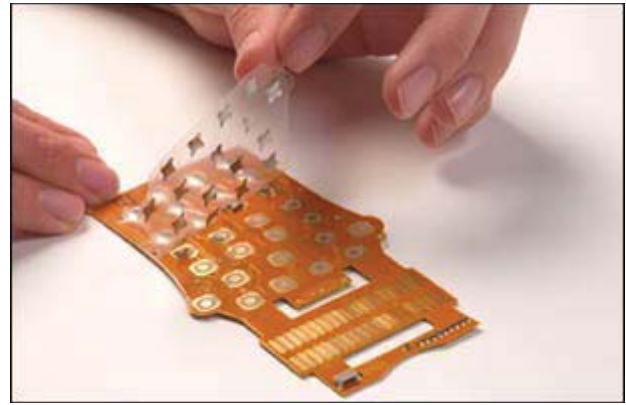

You can do the typical "fold over" as we've shown above or make the keyboard a single layered sandwich to include "domes" to give the user a positive tactile "click" when pressed.

With just a little "Googling around" you'll quickly learn the "ins 'n outs" of making your own personally shaped keypad with custom full color fronts using any color laser printer or copier.

Rock on custom keyboard fans and show us what you've made! Make something really cool looking and shoot us some pics. Every subject is worth \$20 in free supplies and we even pay shipping.

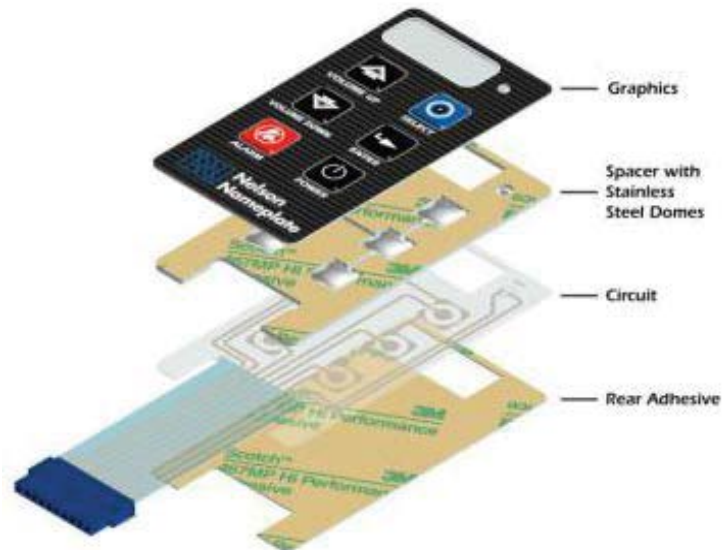

TECH SPECS:

Laminated Sheet Properties per NEMA based on .500 sheet

Minimum Breakdown Voltage	Condition A	45.000
Maximum Permittivity @ 1MHz	Condition A	5.200
Maximum Dissipation Factor @ 1MHz	Condition A	0.025
Minimum Bonding Strength	Condition A	2000.000
Maximum Water Absorption	---	0.10%
Minimum Izod Impact Strength	Lengthwise	7.000
	Crosswise	5.500
Minimum Flexural Strength	Lengthwise	45.000
	Crosswise	35.000

This flex material is manufactured in accordance with **Specification "IPC 4101C/21"** formerly referred to as *Mil-P-13949/4*

Just let your imagination run wild!

