

## CAR1212DC series DC-DC converter

Input:  $-36V_{DC}$  to  $-75V_{DC}$ ; Output:  $12V_{DC}$  @ 1200W;  $3.3V_{DC}$  or  $5V_{DC}$  @ 1A



### Applications

- $48V_{DC}$  distributed power architectures
- Cellular Base Stations
- Satellite Hubs
- Network Equipment
- Network Attached Storage
- Telecom Access Nodes
- Routers/Switches
- Broadband Switches
- ATE Equipment

### Description

The CAR1212DC series of DC-DC Converters provide highly efficient isolated power from DC input mains in a compact 1U industry standard form factor at a power density of  $16.2W/in^3$ . These converters complement the CAR1212FP rectifier providing comprehensive solutions for systems connected either to commercial AC mains,  $48/60V_{DC}$  power plants or telecom central offices. This plug and play approach offers significant advantages since systems can be reconfigured and repositioned readily by simply replacing the power supply. The high-density, front-to-back airflow is designed for minimal space utilization and is highly expandable for future growth. The industry standard PMBus compliant I<sup>2</sup>C communications bus offers a full range of control and monitoring capabilities. The SMBusAlert signal pin alerts customers automatically of any state change within the power supply.

### Features

- Input Or'ing
- Reverse input protection
- 3 front panel LEDs: 1-input;2-output; 3 - fault
- Output programmable from 10.8 –  $13.2V_{DC}$
- Remote ON/OFF control of the  $12V_{DC}$  output
- Remote sense (up to 0.25V) on the  $12V_{DC}$  output
- No minimum load requirements
- Redundant parallel operation
- Active load sharing (single wire)
- Hot pluggable
- Efficiency: typically 90%
- Standby orderable either as  $3.3V_{DC}$  or  $5V_{DC}$
- Auto recoverable OC & OT protection
- Operating temperature:  $-10 - 70^{\circ}C$  (de-rated above  $50^{\circ}C$ )
- Digital status & control: I<sup>2</sup>C and PMBus serial bus
- EN/IEC/UL60950-1 2<sup>nd</sup> edition; UL 1950, CSA C22.2-950
- CE mark
- EMI: class A FCC docket 20780 part 15, EN55022
- Meets EN6100 immunity and transient standards
- Shock & vibration: NEBS GR-63-CORE, level 3

\* UL is a registered trademark of Underwriters Laboratories, Inc.

† CSA is a registered trademark of Canadian Standards Association.

‡ VDE is a trademark of Verband Deutscher Elektrotechniker e.V.

§ This product is intended for integration into end-user equipment. All CE marking procedures of end-user equipment should be followed. (The CE mark is placed on selected products.)

\*\* ISO is a registered trademark of the International Organization of Standards

\* The PMBus name and logo are registered trademarks of the System Management Interface Forum (SMIF)

## CAR1212DC series DC-DC converter

Input:  $-36V_{DC}$  to  $-75V_{DC}$ ; Output:  $12V_{DC}$  @ 1200W;  $3.3V_{DC}$  or  $5V_{DC}$  @ 1A

### Absolute Maximum Ratings

Stresses in excess of the absolute maximum ratings can cause permanent damage to the device. These are absolute stress ratings only, functional operation of the device is not implied at these or any other conditions in excess of those given in the operations sections of the data sheet. Exposure to absolute maximum ratings for extended periods can adversely affect the device reliability.

Parameter	Symbol	Min	Max	Unit
Input Voltage: Continuous	$V_{IN}$	0	75	$V_{DC}$
Operating Ambient Temperature	$T_A$	-10	70 <sup>1</sup>	°C
Storage Temperature	$T_{stg}$	-40	85	°C
I/O Isolation voltage (100% factory Hi-Pot tested)			1500	$V_{DC}$

### Electrical Specifications

Unless otherwise indicated, specifications apply over all operating input voltage, load, and temperature conditions.

INPUT					
Parameter	Symbol	Min	Typ	Max	Unit
Operational Range	$V_{IN}$	-36	-48/60	-75	$V_{DC}$
12V <sub>DC</sub> output turned OFF				-35	
12V <sub>DC</sub> output turned ON				-36	
Idling Power	$W$	12V <sub>DC</sub> output OFF		35	$W$
		12V <sub>DC</sub> output ON		45	
Maximum Input Current ( $V_{OUT}=V_{O, set}, I_{OUT}=I_{O, max}$ )	$I_{IN}$			38	$A_{DC}$
Cold Start Inrush Current (Excluding x-caps, 25°C, <10ms, per ETSI 300-132)	$I_{IN}$			40	$A_{PEAK}$
Efficiency ( $T_{amb}=25°C, V_{IN}=-48V_{DC}, V_{OUT}=12V_{DC}, 60-80\%$ load)	$\eta$		90		%
Holdup time ( $V_{IN}=-48V_{DC}, V_{OUT} \geq 10.8V_{DC}, T_{AMB} 25°C, I_{OUT}=I_{O, max}$ )	$T$		2.5		ms
Isolation	Input/Output	1500			$V_{DC}$
	Input/Frame	1500			$V_{DC}$
	Output/Frame	100			$V_{DC}$

12V <sub>DC</sub> MAIN OUTPUT					
Parameter	Symbol	Min	Typ	Max	Unit
Output power	$P_{OUT}$	0		1200	$W$
Set point @ 50% load	$V_{OUT}$	11.9	12.00	12.1	$V_{DC}$
Overall regulation (load, temperature)		-2		+2	%
Remote sense sum of hot & return				0.25	$V_{DC}$
Ripple and noise <sup>2</sup>				120	$mV_{pp}$

<sup>1</sup> Derated above 50°C at 2.5%/°C

<sup>2</sup> Measured across a 10µf tantalum and a 0.1µf ceramic capacitors in parallel. 20MHz bandwidth

## CAR1212DC series DC-DC converter

Input:  $-36V_{DC}$  to  $-75V_{DC}$ ; Output:  $12V_{DC}$  @ 1200W;  $3.3V_{DC}$  or  $5V_{DC}$  @ 1A

12V <sub>DC</sub> MAIN OUTPUT (continued)					
Parameter	Symbol	Min	Typ	Max	Unit
Turn-ON overshoot	V <sub>OUT</sub>			3	%
Turn-ON delay	T			2	sec
Remote ON/OFF delay time				40	ms
Turn-ON rise time (10 – 90% of V <sub>OUT</sub> )				60	ms
Transient response 50% step [10%-60%, 50% - 100%] (di/dt – 1A/μs, recovery 300μs)	V <sub>OUT</sub>	-5		+5	%
Programmable range (hardware <sup>3</sup> & software)		10.8		13.2	V <sub>DC</sub>
Overvoltage protection, latched (recovery by cycling OFF/ON via hardware or software)		14.5		15.5	V <sub>DC</sub>
Output current V <sub>OUT</sub> = 12V <sub>DC</sub>	I <sub>OUT</sub>	0		100	A <sub>DC</sub>
Current limit, Hiccup Short circuit protection with auto recovery	I <sub>OUT</sub>	110		130	A <sub>DC</sub>
Active current share	I <sub>OUT</sub>	-5		+5	% of FL

3.3V <sub>DC</sub> (5V <sub>DC</sub> ) STANDBY OUTPUT					
Parameter	Symbol	Min	Typ	Max	Unit
Set point (optional 5V <sub>stb</sub> )	V <sub>OUT</sub>	3.2	3.3	3.4	V <sub>DC</sub>
Overall regulation (load, temperature, aging)	V <sub>OUT</sub>	-5		+5	%
Ripple and noise			50	66 <sup>4</sup>	mVp-p
Output current	I <sub>OUT</sub>	0		1	A <sub>DC</sub>

### General Specifications

Parameter	Min	Typ	Max	Units	Notes
Reliability, 25C, full load		250,000		Hrs	MTBF per SR232 Reliability protection for electronic equipment, method I, case III,
Service Life		10		Yrs	Full load, excluding fans
Weight		1.45 (3.2)		Kgs (Lbs)	

### Feature Specifications

Unless otherwise indicated, specifications apply over all operating input voltage, resistive load, and temperature conditions. See Feature Descriptions for additional information.

Parameter	Symbol	Min	Typ	Max	Unit
Remote ON/OFF (Pulled HI internally within the module ≈ 40kΩ to 5V <sub>DC</sub> )					
Logic High (Module ON) – either N/C or apply V > 3V <sub>DC</sub>	I <sub>IH</sub>		—	20	μA
	V <sub>IH</sub>	0.7V <sub>DD</sub>	—	12	V <sub>DC</sub>
Logic Low (Module OFF)	I <sub>IL</sub>	—	—	1	mA
	V <sub>IL</sub>	0	—	0.8	V <sub>DC</sub>

<sup>3</sup> Setpoint can be voltage programmable or programmed by a resistor divider. An internal 20kΩ from V<sub>prog</sub> to 3.3V<sub>DC</sub> is provided. Add a resistor to complete the divider from V<sub>prog</sub> to output\_return.

<sup>4</sup> Measured at the output with 0.1μf ceramic and a 10μf tantalum capacitor in parallel. 20MHz bandwidth limitation.

## CAR1212DC series DC-DC converter

Input:  $-36V_{DC}$  to  $-75V_{DC}$ ; Output:  $12V_{DC}$  @ 1200W;  $3.3V_{DC}$  or  $5V_{DC}$  @ 1A

### Feature Specifications (continued)

Parameter	Symbol	Min	Typ	Max	Unit
Output Voltage programming (Vprog) Equation: $V_{OUT} = 10.8 + (V_{prog} * 0.96)$					
Vprog range	Vprog	0	—	2.5	V <sub>DC</sub>
Programmed output voltage range	Vo	10.8	—	13.2	V <sub>DC</sub>
Voltage adjustment resolution (8-bit A/D)	Vo	—	10	—	mV <sub>DC</sub>
Output configured to 13.2V <sub>DC</sub>	Vprog	2.5	—	3.0	V <sub>DC</sub>
Output configured to the 12V <sub>DC</sub> set-point	Vprog	3.0	—	—	V <sub>DC</sub>
Enable [short pin controlling presence of the 12V <sub>DC</sub> output]					
12V output OFF	Vi	0.7V <sub>DD</sub>	—	12	V <sub>DC</sub>
12V output ON	Vi	0	—	0.8	V <sub>DC</sub>
Write protect (Wp)					
Write protect enabled	Vi	0.7V <sub>DD</sub>	—	12	V <sub>DC</sub>
Write protect disabled	Vi	0	—	0.8	V <sub>DC</sub>
INPUT-OK (Pulled up internally to 3.3V via a 10kΩ resistor)					
Logic High (Input within normal range)	IOH	—	—	20	μA
	VOH	0.7V <sub>DD</sub>	—	12	V <sub>DC</sub>
Logic Low (Input out of range)	IOL	—	—	20	mA
	VOL	0	—	0.4	V <sub>DC</sub>
DC-OK (Pulled up internally to 3.3V via a 10kΩ resistor)					
Logic High (Output voltage is present)	IOH	—	—	20	μA
	VOH	0.7V <sub>DD</sub>	—	12	V <sub>DC</sub>
Logic Low (Output voltage is not present)	IOL	—	—	20	mA
	VOL	0	—	0.4	V <sub>DC</sub>
Temperature OK (Pulled up internally to 3.3V via a 10kΩ resistor)					
Logic High (temperature within normal range)	IOH	—	—	20	μA
	VOH	0.7V <sub>DD</sub>	—	12	V <sub>DC</sub>
Logic Low (temperature is too high)	IOL	—	—	20	mA
	VOL	0	—	0.4	V <sub>DC</sub>
Delayed shutdown after Logic Low transition	Tdelay	10	—	—	sec
Fault (Pulled up internally to 3.3V via a 10kΩ resistor)					
Logic High (No fault is present)	IOH	—	—	20	μA
	VOH	0.7V <sub>DD</sub>	—	12	V <sub>DC</sub>
Logic Low (Fault is present)	IOL	—	—	20	mA
	VOL	0	—	0.4	V <sub>DC</sub>
PS Present					
Logic High (Power supply is not plugged in)					
Logic Low (Power supply is present)	VIL	0	—	0.1	V <sub>DC</sub>

## CAR1212DC series DC-DC converter

Input:  $-36V_{DC}$  to  $-75V_{DC}$ ; Output:  $12V_{DC}$  @ 1200W;  $3.3V_{DC}$  or  $5V_{DC}$  @ 1A

### Feature Specifications (continued)

Parameter	Symbol	Min	Typ	Max	Unit
SMBAlert# (Interrupt) (Pulled up internally to 3.3V via a 10k $\Omega$ resistor)					
Logic High (No Alert - normal)	$I_{OH}$		—	20	$\mu A$
	$V_{OH}$	$0.7V_{DD}$	—	12	$V_{DC}$
Logic Low (Alert is set)	$I_{OL}$	—	—	20	mA
	$V_{OL}$	0	—	0.4	$V_{DC}$
Output current monitor (I <sub>mon</sub> )					
Resolution			100		mV/A
Accuracy		-250		+250	mV
Measurement range	$I_o$	0		100	A <sub>DC</sub>
Analog output range	$V_{mon}$	0		10	$V_{DC}$
Sourced output current	$I_o$			5	mA <sub>DC</sub>

### Digital Interface Specifications

Parameter	Conditions	Symbol	Min	Typ	Max	Unit
<b>PMBus Signal Interface Characteristics</b>						
Input Logic High Voltage (CLK, DATA)		$V_{IH}$	2.1		3.6	$V_{DC}$
Input Logic Low Voltage (CLK, DATA)		$V_{IL}$	0		0.8	$V_{DC}$
Input high sourced current (CLK, DATA)		$I_{IH}$	0		10	$\mu A$
Output Low sink Voltage (CLK, DATA, SMBALERT#)	$I_{OUT}=3.5mA$	$V_{OL}$			0.4	$V_{DC}$
Output Low sink current (CLK, DATA, SMBALERT#)		$I_{OL}$	3.5			mA
Output High open drain leakage current (CLK, DATA, SMBALERT#)	$V_{OUT}=3.6V$	$I_{OH}$	0		10	$\mu A$
PMBus Operating frequency range	Slave Mode	FPMB	10		400	kHz
<b>Measurement System Characteristics</b>						
Clock stretching		$t_{STRETCH}$			25	ms
$I_{OUT}$ measurement range	Linear	$I_{RNG}$	0		100	A <sub>DC</sub>
$I_{OUT}$ measurement accuracy 25°C		$I_{ACC}$	-10		+10	%
$V_{OUT}$ measurement range	Linear	$V_{OUT(rng)}$	0		14	$V_{DC}$
$V_{OUT}$ measurement accuracy		$V_{OUT(acc)}$	-5		+5	%
Temp measurement range	Linear	$Temp_{(rng)}$	0		120	°C
Temp measurement accuracy <sup>5</sup>		$Temp_{(acc)}$	-5		+5	%

<sup>5</sup> Temperature accuracy reduces non-linearly with decreasing temperature

## CAR1212DC series DC-DC converter

Input: -36V<sub>DC</sub> to -75V<sub>DC</sub>; Output: 12V<sub>DC</sub> @ 1200W; 3.3V<sub>DC</sub> or 5 V<sub>DC</sub> @ 1A

### Environmental Specifications

Parameter	Min	Typ	Max	Units	Notes
Ambient Temperature	-10 <sup>6</sup>		70	°C	Air inlet from sea level to 5,000 feet.
Storage Temperature	-40		85	°C	
Operating Altitude			2250/7382	m / ft	
Non-operating Altitude			8200/30k	m / ft	
Power Derating with Temperature			2.5	%/°C	51°C to 70°C <sup>7</sup>
Operating Temperature Derating with Altitude			2.0	°C/305 m °C/1000 ft	Above 2250/7382 m/ft; 3962/13000 m/ft max
Acoustic noise		55		dbA	25°C, half load
Humidity Operating Storage	30 10		95 95	% %	Relative humidity, non-condensing
Shock and Vibration acceleration			6	Grms	NEBS GR-63-CORE, Level 3, 20 -2000Hz, min 30 minutes
Earthquake Rating	4			Zone	NEBS GR-63-CORE, all floors, Seismic Zone 4 Designed and tested to meet NEBS specifications.

### EMC Compliance

EMC				
Parameter	Criteria	Standard	Level	Test
DC input	Conducted emissions	EN55022, FCC Docket 20780 part 15, subpart J Telcordia GR1089-CORE, Class A	A	0.15 – 30MHz
	Radiated emissions	EN55022	A	30 – 10000MHz
DC input immunity	Voltage dips	EN61000-4-11	B	-30%, 10ms
			B	-60%, 100ms
			B	-100%, 5sec
	Voltage surge	EN61000-4-5	A	2kV, 1.2/50µs, common mode
A			1kV, 1.2/50µs, differential mode	
	Fast transients	EN61000-4-4	B	5/50ns, 1kV (common mode)
Enclosure immunity	Conducted RF fields	EN61000-4-6	A	130dBµV, 0.15-80MHz, 80% AM
	Radiated RF fields	EN61000-4-3, level 3	A	10V/m, 80-1000MHz, 80% AM
		ENV50140	A	
	ESD	EN61000-4-2, level 3	B	6kV contact, 8kV air

<sup>6</sup> Designed to start at an ambient down to -40°C; meet spec after ≅ 30 min warm up period, may not meet operational limits below -10°C.

<sup>7</sup> The maximum operational ambient is reduced in Europe in order to meet certain power cord maximum ratings of 70°C. The maximum operational ambient where 70°C rated power cords are utilized is reduced to 60°C until testing demonstrates that a higher level is acceptable.

# CAR1212DC series DC-DC converter

Input:  $-36V_{DC}$  to  $-75V_{DC}$ ; Output:  $12V_{DC}$  @  $1200W$ ;  $3.3V_{DC}$  or  $5V_{DC}$  @  $1A$

## Characteristic Curves

The following figures provide typical characteristics for the CAR1212DC converter at  $25^{\circ}C$

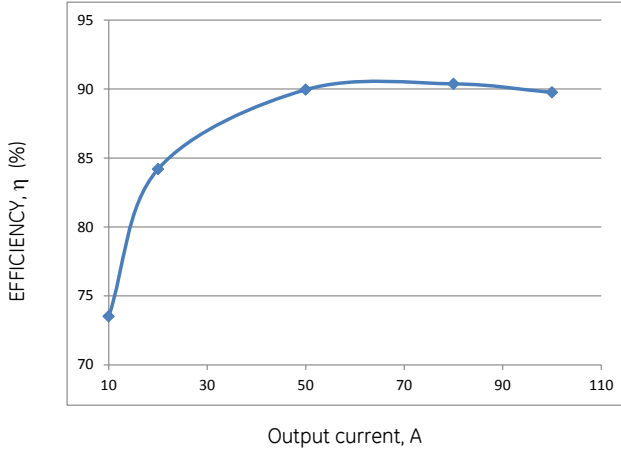

Figure 1. Converter Efficiency versus Output Current.

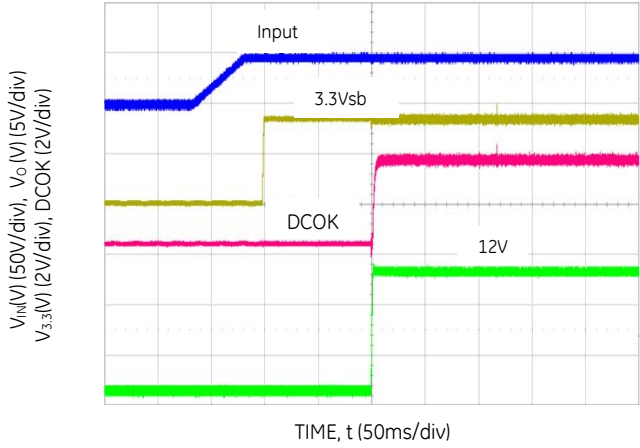

Figure 2. Input start up ( $V_{in} = -48V_{DC}$ , full load).

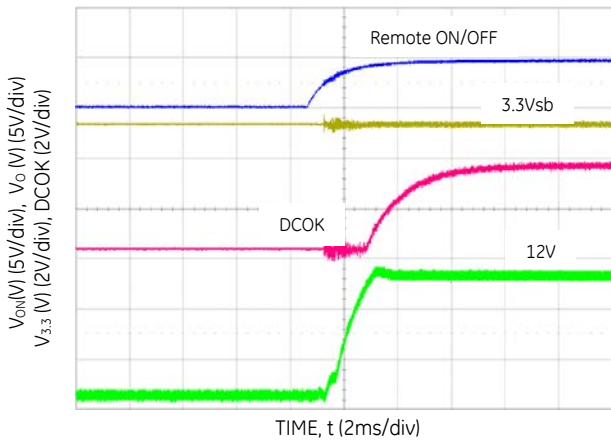

Figure 3. Start-up Using Remote On/Off ( $V_{in} = -48V_{DC}$ , full load)

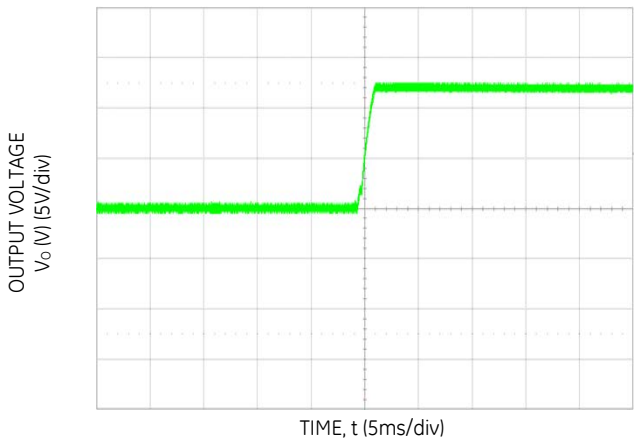

Figure 4. 12V start-up ( $V_{in} = -48V_{DC}$ , full load)

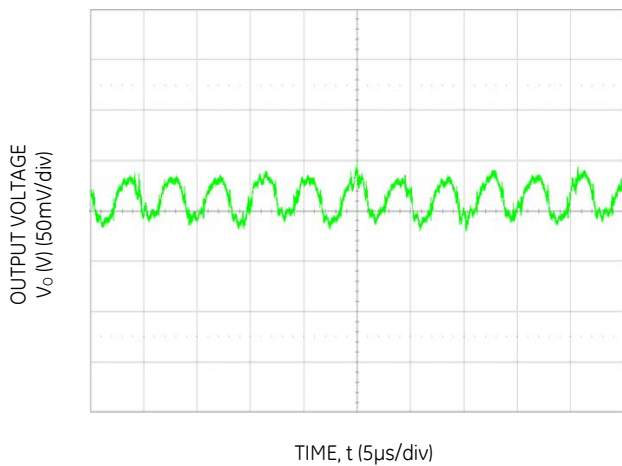

Figure 5. 12V output ripple and noise ( $V_{in} = -48V_{DC}$ , full load).

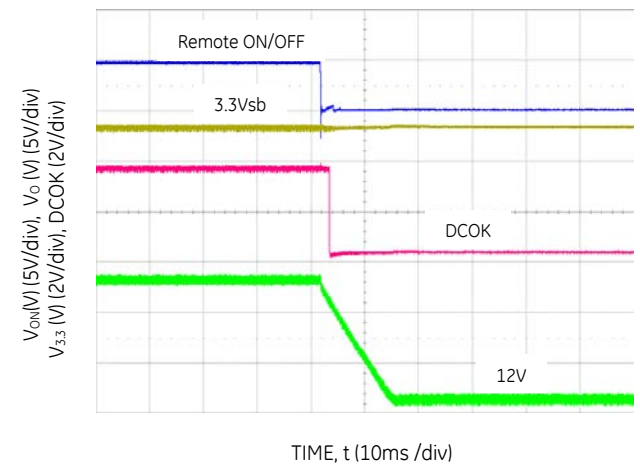

Figure 6. Turn-OFF via Remote ON/OFF ( $V_{in} = -48V_{DC}$ , full load)

# CAR1212DC series DC-DC converter

Input:  $-36V_{DC}$  to  $-75V_{DC}$ ; Output:  $12V_{DC}$  @ 1200W;  $3.3V_{DC}$  or  $5V_{DC}$  @ 1A

## Characteristic Curves (continued)

The following figures provide typical characteristics for the CAR1212DC converter at 25°C.

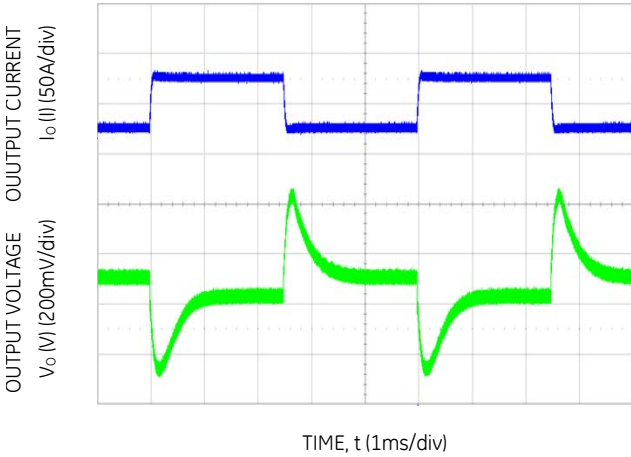

Figure 7. Transient response 12V<sub>DC</sub> output load step 10 – 60A, V<sub>IN</sub> = -48V<sub>DC</sub>.

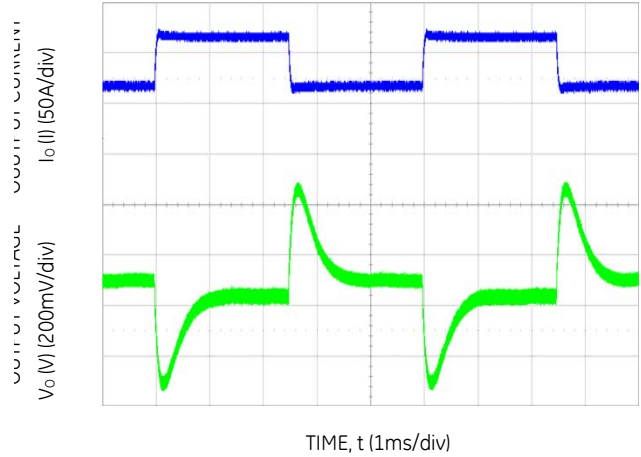

Figure 8. Transient response 12V<sub>DC</sub> output load step 50 – 100A, V<sub>IN</sub> = -48V<sub>DC</sub>.

SYSTEM CURRENT	I <sub>o</sub>	PS1 I <sub>1</sub> (A)	PS2 I <sub>2</sub> (A)	% Share
	0 A	-	-	-
20 A	8.10	11.80	18.59	
40 A	17.30	22.70	13.50	
60 A	28.30	31.40	5.19	
80 A	39.40	40.80	1.75	
100 A	50.00	50.30	0.30	
120 A	60.90	59.60	1.08	
140 A	70.40	69.40	0.72	
160 A	80.90	79.70	0.75	
180 A	91.40	89.50	1.05	
200 A	101.90	98.80	1.54	

INDIVIDUAL UNIT CURRENTS AND % SHARE

Table 9. Current share between two modules

CONDITION	No Load	Max Load
V <sub>OUT</sub> @ TURN ON	32.7V <sub>DC</sub>	32.6V <sub>DC</sub>
V <sub>OUT</sub> @ TURN OFF	29.5V <sub>DC</sub>	30.5V <sub>DC</sub>

Table 10. Input Turn OFF and Turn ON.

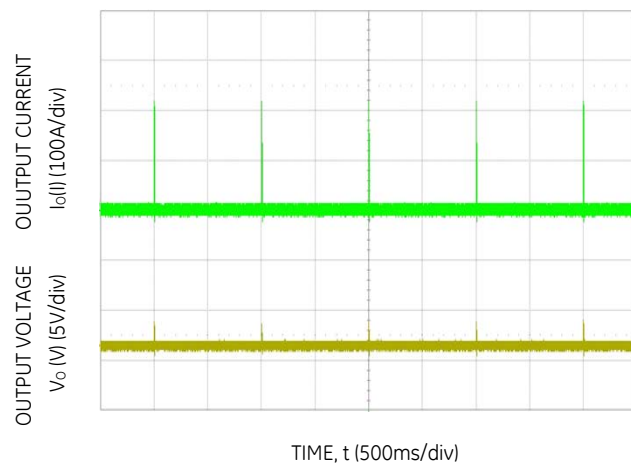

Figure 11. Overload: output short circuit performance, the unit is in hiccup mode, V<sub>IN</sub> = -48V<sub>DC</sub>.

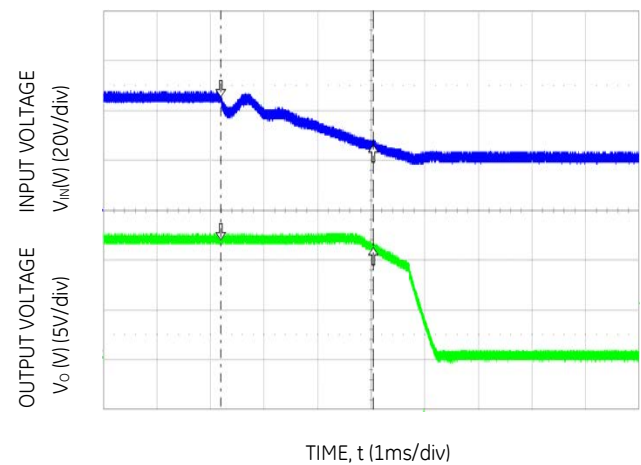

Figure 12. Holdup time: full load V<sub>in</sub> = -48V<sub>DC</sub> duration: 2.84ms



# CAR1212DC series DC-DC converter

Input: -36V<sub>DC</sub> to -75V<sub>DC</sub>; Output: 12V<sub>DC</sub> @ 1200W; 3.3V<sub>DC</sub> or 5 V<sub>DC</sub> @ 1A

## Control and Status

**Control hierarchy:** Some features, such as output voltage, can be controlled both through hardware and firmware. For example, the output voltage is controlled both by the signal pin (Vprog) and the PMBus command, (Vout\_command) .

Using output voltage as an example; the Vprog signal pin has ultimate control of the output voltage until the Vprog is either > 3V<sub>DC</sub> or a no connect. When the programming signal via Vprog is either a no connect or > 3V<sub>DC</sub>, it is ignored, the output voltage is set at its nominal 12V<sub>DC</sub> and the unit output voltage can be controlled via the PMBus command, (Vout\_command).

**Analog controls:** Details of analog controls are provided in this data sheet under Signal Definitions.

**Common ground:** All signals and outputs are referenced to Output return. These include 'Vstb return' and 'Signal return'.

## Control Signals

**Voltage programming (Vprog):** An analog voltage on this signal can vary the output voltage from 10.8V<sub>DC</sub> to 13.2V<sub>DC</sub>. The equation of this signal is:

$$V_{OUT} = 10.8 + (V_{prog} * 0.96) \text{ where } V_{prog} = 0.1 \text{ to } 2.5V$$

Between 2.5 and 3V the output stays at 13.2V<sub>DC</sub>. If Vprog is > 3V, or left open, the programming signal is ignored and the unit output is set at the setpoint of 12V<sub>DC</sub>.

**Load share (Ishare):** This is a single wire analog signal that is generated and acted upon automatically by power supplies connected in parallel. The Ishare pins should be tied together for power supplies if active current share among the power supplies is desired. No resistors or capacitors should get connected to this pin.

**Remote ON/OFF:** Controls presence of the main 12V<sub>DC</sub> output voltage on the output connector. This signal is pulled HI internally. Leaving this pin a no-connect turns ON the 12V<sub>DC</sub> output. Applying a Logic 0 (TTL LO level) to this pin turns OFF the 12V<sub>DC</sub> output.

A turn OFF command either through this signal (Remote ON/OFF) or firmware commanded would turn OFF the 12V output.

**Enable:** This is a short signal pin that controls the presence of the 12V<sub>DC</sub> on the output connector. This pin should be connected to 'output return' on the system side of the output connector. The purpose of this pin is to ensure that the output turns ON after engagement of the power blades and turns OFF prior to disengagement of the power blades.

**Write protect (WP):** This signal protects the contents of the EEPROM from accidental over writing. When left open the EEPROM is write protected. A LO (TTL compatible) permits writing to the EEPROM. This signal is pulled HI internally by the power supply.

## Status signals

**Output current monitor (Imon):** A voltage level proportional to the delivered output current is present on this pin. The signal level is 0.1V per amp ± 0.25V.

**INPUT OK:** A TTL compatible status signal representing whether the input voltage is within the anticipated range. This signal needs to be pulled HI externally through a resistor. Open collector (HI) on this signal indicates that the input voltage is applied within the specified input range.

**DC OK:** A TTL compatible status signal representing whether the output voltage is present. This signal needs to be pulled HI externally through a resistor. Open collector (HI) on this signal indicates that the output voltage is present.

**Temperature OK:** A TTL compatible status signal representing whether an over temperature exists. This signal needs to be pulled HI externally through a resistor. Open collector (HI) on this signal indicates that temperatures are normal.

If an over temperature should occur, this signal would pull LO for approximately 10 seconds prior to shutting down the power supply. The unit would restart if internal temperatures reduce within normal operational levels. At that time the signal reverts back to its open collector (HI) state.

**Fault:** A TTL compatible status signal representing whether a Fault occurred. This signal needs to be pulled HI externally through a resistor. Open collector (HI) on this signal indicates that no Fault is present.

This signal activates for OTP, OVP, OCP, INPUT fault or No output.

**PS Present:** This pin is connected to 'output return' within the power supply. Its intent is to indicate to the system that a power supply is present. This signal may need to be pulled HI externally through a resistor to detect a missing module.

**Interrupt (SMBAlert):** A TTL compatible status signal, representing the SMBusAlert# feature of the PMBus compatible i<sup>2</sup>C protocol in the power supply. This signal needs to be pulled HI externally through a resistor. Open collector (HI) on this signal indicates that no Interrupt has been triggered.

## Serial Bus Communications

The I<sup>2</sup>C interface incorporated within the CAR1212DC modules facilitates the monitoring and control of various operating parameters within the unit and transmits these on demand over an industry standard I<sup>2</sup>C Serial bus.

All signals are referenced to 'Signal Return'.

**Device addressing:** The microcontroller (MCU) and the EEPROM have the following addresses:

Device	Address	Address Bit Assignments (Most to Least Significant Bit)							
MCU	0xBx	1	0	1	1	A2	A1	A0	R/W
Broadcast	0x00	0	0	0	0	0	0	0	0
EEPROM	0xAx	1	0	1	0	A2	A1	A0	R/W

The **Global Broadcast** instruction executes a simultaneous **write** instruction to all power supplies. A **read** instruction cannot be accessed globally. The three programmable address bits are the same for all I<sup>2</sup>C accessible devices within the power supply.

**Address lines (A2, A1, A0):** These signal pins allow up to eight (8) CAR1212DC modules to be addressed on a single I<sup>2</sup>C bus. The pins are pulled HI internal to the power supply. For a logic LO these pins should be connected to 'Output Return'

**Serial Clock (SCL):** The clock pulses on this line are generated by the host that initiates communications across the I<sup>2</sup>C Serial bus. This signal is pulled up internally to 3.3V by a 10kΩ resistor. The end user should add additional pull up resistance as necessary to ensure that rise and fall time timing and the maximum sink current is in compliance to the I<sup>2</sup>C specifications.

**Serial Data (SDA):** This line is a bi-directional data line. This signal is pulled up internally to 3.3V by a 10kΩ resistor. The end user should add additional pull up resistance as necessary to ensure that rise and fall time timing and the maximum sink current is in compliance to the I<sup>2</sup>C specifications.

# CAR1212DC series DC-DC converter

Input: -36V<sub>DC</sub> to -75V<sub>DC</sub>; Output: 12V<sub>DC</sub> @ 1200W; 3.3V<sub>DC</sub> or 5 V<sub>DC</sub> @ 1A

## Digital Feature Descriptions

**PMBus™ compliance:** The power supply is fully compliant to the Power Management Bus (PMBus™) rev1.2 requirements. Manufacturer specific commands located between addresses 0xD0 to 0xEF provide instructions that either do not exist in the general PMBus specification or make the communication interface simpler and more efficient.

**Master/Slave:** The 'host controller' is always the MASTER. Power supplies are always SLAVES. SLAVES cannot initiate communications or toggle the Clock. SLAVES also must respond expeditiously at the command of the MASTER as required by the clock pulses generated by the MASTER.

**Clock stretching:** The 'slave' µController inside the power supply may initiate clock stretching if it is busy and it desires to delay the initiation of any further communications. During the clock stretch the 'slave' may keep the clock LO until it is ready to receive further instructions from the host controller. The maximum clock stretch interval is 25ms.

The host controller needs to recognize this clock stretching, and refrain from issuing the next clock signal, until the clock line is released, or it needs to delay the next clock pulse beyond the clock stretch interval of the power supply.

Note that clock stretching can only be performed after completion of transmission of the 9<sup>th</sup> ACK bit, the exception being the START command.

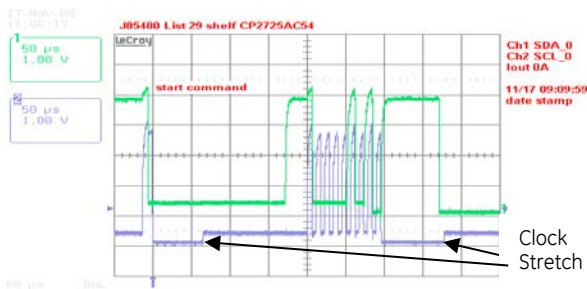

Figure 13. Example waveforms showing clock stretching.

**I<sup>2</sup>C Bus Lock-Up detection:** The device will abort any transaction and drop off the bus if it detects the bus being held low for more than 35ms.

**Communications speed:** Both 100kHz and 400kHz clock rates are supported. The power supplies default to the 100kHz clock rate. The minimum clock speed specified by SMBus is 10 kHz.

**Packet Error Checking (PEC):** Although the power supply will respond to commands with or without the trailing PEC, it is highly recommended that PEC be used in all communications. The integrity of communications is compromised if packet error correction is not employed. There are many functional features, including turning OFF the main output, that should require validation to ensure that the correct command is executed.

PEC is a CRC-8 error-checking byte, based on the polynomial  $C(x) = x^8 + x^2 + x + 1$ , in compliance with PMBus™ requirements. The calculation is based in all message bytes, including the originating write address and command bytes preceding read instructions. The PEC is appended to the message by the device that supplied the last byte.

**SMBAlert#:** The µC driven SMBAlert# signal informs the 'master/host' controller that either a STATE or ALARM change has occurred. Normally this signal is HI. The signal will change to its LO level if the power supply has changed states and the signal will be latched LO until the power supply either receives a 'clear' instruction as outlined below or executes a READ STATUS\_WORD. If the alarm state is still present after the STATUS registers were reset, then the signal will revert back into its LO state again and will latch until a subsequent reset signal is received from the host controller.

The signal will be triggered for any state change, including the following conditions:

- VIN and under or over voltage
- IOUT over current
- Over Temperature warning or fault
- Fan Failure
- Communication error
- PEC error
- Invalid command
- Internal faults

The power supply will clear the SMBAlert# signal (release the signal to its HI state) upon the following events:

- Receiving a CLEAR\_FAULTS command
- The main output recycled (turned OFF and then ON) via the ENABLE signal pin
- The main output recycled (turned OFF and then ON) by the OPERATION command
- Execution of a READ of the STATUS\_WORD register

**Global broadcast:** This is a powerful command because it can instruct all power supplies to respond simultaneously in one command. But it does have a serious disadvantage. Only a single power supply needs to pull down the ninth *acknowledge* bit. To be certain that each power supply responded to the global instruction, a READ instruction should be executed to each power supply to verify that the command properly executed. The GLOBAL BROADCAST command should only be executed for write instructions to slave devices.

**Read back delay:** The power supply issues the SMBAlert# notification as soon as the first state change occurred. During an event a number of different states can be transitioned to before the final event occurs. If a read back is implemented rapidly by the host a successive SMBAlert# could be triggered by the transitioning state of the power supply. In order to avoid the triggering of successive SMBAlert#s and thus reading a transitioning state, it is prudent to wait more than 2 seconds after the receipt of an SMBAlert# before executing a read back. This delay will ensure that only the final state of the power supply is captured.

**Successive read backs:** Successive read backs to the power supply should not be attempted at intervals faster than every one second. This time interval is sufficient for the internal processors to update their data base so that successive reads provide fresh data.

## PMBus™ Commands

**Standard instruction:** Up to two bytes of data may follow an instruction depending on the required data content. Analog data is always transmitted as LSB followed by MSB. PEC is optional and includes the address and data fields.

1	8	1	8	1
S	Slave address	Wr	A	Command Code

8	1	8	1	8	1	1
Low data byte	A	High data byte	A	PEC	A	P

□ Master to Slave    □ Slave to Master  
 SMBUS annotations; S – Start, Wr – Write, Sr – re-Start, Rd – Read, A – Acknowledge, NA – not-acknowledged, P – Stop

# CAR1212DC series DC-DC converter

Input: -36V<sub>DC</sub> to -75V<sub>DC</sub>; Output: 12V<sub>DC</sub> @ 1200W; 3.3V<sub>DC</sub> or 5 V<sub>DC</sub> @ 1A

**Standard READ:** Up to two bytes of data may follow a READ request depending on the required data content. Analog data is always transmitted as LSB followed by MSB. PEC is optional and includes the address and data fields.

1	7	1	1	8	1
S	Slave address	Wr	A	Command Code	A

1	7	1	1	8	1
Sr	Slave Address	Rd	A	LSB	A

8	1	8	1	1	1
MSB	A	PEC	No-ack	P	

**Block instruction:** When writing or reading more than two bytes of data at a time BLOCK instructions for WRITE and READ commands must be used instead of the Standard Instructions.

Block write format:

1	7	1	1	8	1
S	Slave address	Wr	A	Command Code	A

8	1	8	1	8	1
Byte count = N	A	Data 1	A	Data 2	A

8	1	8	1	8	1	1
.....	A	Data 48	A	PEC	A	P

Block read format:

1	7	1	1	8	1
S	Slave address	Wr	A	Command Code	A

1	7	1	1
Sr	Slave Address	Rd	A

8	1	8	1	8	1
Byte count = N	A	Data 1	A	Data 2	A

8	1	8	1	8	1	1
.....	A	Data 48	A	PEC	NoAck	P

**Linear Data Format** The definition is identical to Part II of the PMBus Specification. All standard PMBus values, with the exception of output voltage related functions, are represented by the linear format described below. Output voltage functions are represented by a 16 bit mantissa. Output voltage has a E=9 constant exponent.

The Linear Data Format is a two byte value with an 11-bit, two's complement mantissa and a 5-bit, two's complement exponent or scaling factor, its format is shown below.

Data Byte High					Data Byte Low											
Bit	7	6	5	4	3	2	1	0	7	6	5	4	3	2	1	0
	Exponent (E)					Mantissa (M)										

The relationship between the Mantissa, Exponent, and Actual Value (V) is given by the following equation:

$$V = M * 2^E$$

Where:

V is the value

M is the 11-bit, two's complement mantissa

E is the 5-bit, two's complement exponent

## PMBus™ Command set:

Command	Hex Code	Data Byte	Write	Function
Operation	01	1	W	Output ON/OFF
ON_OFF_config	02	1		
Clear_faults	03	0		Clear Status
Write_protect	10	1	W	Write control
Store_default_all	11	0	W	Store permanently
Restore_default_all	12	0		Reset defaults
Vout_mode	20	1		Vout constants
Vout_command	21	2	W	Set Vout
Fan_config_1_2	3A	1	W	RPM or duty cycle
Fan_command_1	3B	2	W	Set fan speed
Vout_OV_fault_limit	40	2	W	Set OV fault limit
Vout_OV_fault_response	41	1		Latch only
Vout_OV_warn_limit	42	2	W	Set OV warn limit
lout_OC_fault_response	47	1	W	Latch, restart, folddown
lout_OC_warn_limit	4A	2	W	Set OC warn limit
OT_fault_limit	4F	2	W	Set OT fault limit
OT_fault_response	50	1	W	Latch, restart
OT_warn_limit	51	2	W	Set OT warn limit
Status_byte	78	1		
Status_word	79	2		
Status_Vout	7A	1		
Status_lout	7B	1		
Status_input	7C	1		
Status_temperature	7D	1		
Status_CML	7E	1		
Status_mfr_specific	80	1		
Status_fan_1_2	81	1		
Read_Vout	8B	2		Read Vout
Read_lout	8C	2		Read lout
Read_temperature_1	8D	2		Read Temperature
PMBus revision	98	1		
Read fan_speed	90	2		Read speed in RPM
Mfr_ID	99	5		FRU_ID
Mfr_model	9A	16		
Mfr_revision	9B	4		
Mfr_location	9C	4		
Mfr_date	9D	6		
Mfr_serial	9E	15		
Mfr_Vin_min	A0	2		36V (linear format)
Mfr_Vin_max	A1	2		75V (linear format)
Mfr_lin_max	A2	2		40A (linear format)
Mfr_Pin_max	A3	2		1400W (linear format)
Mfr_Vout_min	A4	2		10V (linear format)
Mfr_Vout_max	A5	2		15V (linear format)
Mfr_lout_max	A6	2		100A (linear format)
Mfr_Pout_max	A7	2		1200W (linear format)
Mfr_Tambient_max	A8	2		70C (linear format)
Mfr_Tambient_min	A9	2		-10C (linear format)
FRW_revison	D0	1		
Fan_duty_cycle_1°C	D6	1		Duty_cycle read in %
OTF_RECOVERY_1°C	E5	2		Recovery hysteresis °C
DCOKHI_1°C	E6	2		(1/512V)
DCOKLO_1°C	E7	2		(1/512V)

# CAR1212DC series DC-DC converter

Input: -36V<sub>DC</sub> to -75V<sub>DC</sub>; Output: 12V<sub>DC</sub> @ 1200W; 3.3V<sub>DC</sub> or 5 V<sub>DC</sub> @ 1A

## Status Register Bit Allocation:

Register	Hex Code	Data Byte	Function
Status_Byte [ 0 - normal 1 - fault]	78	7	Busy
		6	DC_OFF
		5	Output OV Fault
		4	Output OC Fault
		3	Input UV Fault
		2	Temp Fault/warning
		1	CML (communication fault)
		0	None of Below
Status_word (includes Status_byte) [ 0 - normal 1 - fault]	79	7	OV Fault/Warning detected
		6	OC Fault/Warning detected
		5	Input Fault/Warning
		4	Mfr_specific register change
		3	nPower_Good
		2	Fan Fault or Warning
		1	Other fault
		0	Unknown
Status_Vout [ 0 - normal 1 - fault]	7A	7	Vout OV Fault
		6	Vout OV Warning
		5	Vout UV Warning
		4	Vout UV Fault
		3	N/A
		2	N/A
		1	N/A
		0	N/A
Status_Iout [ 0 - normal 1 - fault]	7B	7	IOUT OC Fault
		6	N/A
		5	IOUT OC Warning
		4	N/A
		3	N/A
		2	N/A
		1	N/A
		0	N/A
Status_input [ 0 - normal 1 - fault]	7C	7	Vin OV Fault
		6	Vin OV Warning
		5	Vin UV Warning
		4	Vin UV Fault
		3	N/A
		2	N/A
		1	N/A
		0	N/A
Status_temperature [ 0 - normal 1 - fault]	7D	7	OT Fault
		6	OT Warning
		5	N/A
		4	N/A
		3	N/A
		2	N/A
		1	N/A
		0	N/A
Status_cml [ 0 - normal 1 - fault]	7E	7	Invalid/Unsupported Command
		6	Invalid/Unsupported Data
		5	Packet Error Check Failed
		4	Memory Fault Detected
		3	Processor Fault Detected
		2	Reserved
		1	Other Communications Fault
		0	Other Memory or Logic Fault

Register	Hex Code	Data Byte	Function
Status_mfr_specific [ 1 - normal 0 -fault]	80	7	3.3V_fault
		6	OVSD
		5	Interrupt
		4	Fault detected
		3	PS_remote_OFF
		2	DC_fault
		1	INPUT_fault
		0	N/A
Status_fan_1_2 [ 0 - normal 1 - fault]	81	7	Fan 1 Fault
		6	Fan 2 Fault
		5	N/A
		4	N/A
		3	Fan 1 Speed Overridden
		2	Fan 2 Speed Overridden
		1	N/A
		0	N/A

## Command Descriptions

**Operation (01)** : By default the Power supply is turned **ON** at power up as long as Power ON/OFF signal pin is active HI. The Operation command is used to turn the Power Supply ON or OFF via the PMBus. The data byte below follows the OPERATION command.

FUNCTION	DATA BYTE
Unit ON	80
Unit OFF	00

To **RESET** the power supply cycle the power supply OFF, wait at least 2 seconds, and then turn back ON. All alarms and shutdowns are cleared during a restart.

**Clear\_faults (03)**: This command clears all STATUS and FAULT registers and resets the SMBAlert# line.

If a fault still persists after the issuance of the clear\_faults command the specific registers indicating the fault are reset and the SMBAlert# line is activated again.

**WRITE\_PROTECT register (10)**: Used to control writing to the PMBus device. The intent of this command is to provide protection against accidental changes. All supported command parameters may have their parameters read, regardless of the write\_protect settings. The contents of this register can be stored to non-volatile memory using the Store\_default\_code command. The default setting of this register is disable\_all\_writes except write\_protect 0x80h. This default cannot be changed.

FUNCTION	DATA BYTE
Enable all writes	00
Disable all writes except write_protect	80
Disable all writes except write_protect and OPERATION	

**Vout\_Command (21)** : This command is used to change the output voltage of the power supply. Changing the output voltage should be performed simultaneously to all power supplies operating in parallel using the Global Address (Broadcast) feature. If only a single power supply is instructed to change its output, it may attempt to source all the required power which can cause either a power limit or shutdown condition.

Software programming of output voltage permanently overrides the set point voltage configured by the **Vprog** signal pin. The program no longer looks at the **Vprog** pin and will not respond to any hardware voltage settings. If power is removed from the  $\mu$ Controller it will reset itself into its default configuration looking at the **Vprog** signal for output voltage control. In many applications,

# CAR1212DC series DC-DC converter

Input: -36V<sub>DC</sub> to -75V<sub>DC</sub>; Output: 12V<sub>DC</sub> @ 1200W; 3.3V<sub>DC</sub> or 5 V<sub>DC</sub> @ 1A

the **Vprog** pin is used for setting initial conditions, if different than the factory setting. Software programming then takes over once I<sup>2</sup>C communications are established.

**Vout\_OV[OT]\_fault\_limit (40[4F]):** Provides the capability to change the OV[OT] shutdown limit. No sanity check exists to ensure that the changed value is within the expected range. However, if the value exceeds the maximum limit, the program will default to the maximum value.

**Vout\_OV[OT]\_warn\_limit (42[51]):** **OV[OT]\_warning** is extremely useful because it gives the system controller a heads up that the output voltage/temperature is drifting out of regulation and the power supply is close to shutting down. Preemptive action may be taken before the power supply would shut down and potentially disable the system.

**OC and OT\_fault\_response (47, 50):** The default response for OC is latched on fault. The response for OT is auto\_restart once internal temperatures cool down.

**Restart after a latch off:** Either of four restart possibilities are available. The hardware pin **Remote ON/OFF** may be turned OFF and then ON. The unit may be commanded to restart via i2c through the *Operation* command by first turning OFF then turning ON. The third way to restart is to remove and reinsert the unit. The fourth way is to turn OFF and then turn ON ac power to the unit. The fifth way is by changing firmware from **latch off** to **restart**. Each of these commands must keep the power supply in the OFF state for at least 2 seconds, with the exception of changing to **restart**.

A power system that is comprised of a number of power supplies could have difficulty restarting after a shutdown event because of the non-synchronized behavior of the individual power supplies. Implementing the latch-off mechanism permits a synchronized restart that guarantees the simultaneous restart of the entire system.

A synchronous restart can be implemented by:

1. Issuing a GLOBAL OFF and then ON command to all power supplies,
2. Toggling Off and then ON the **Remote ON/OFF** signal
3. Removing and reapplying input commercial power to the entire system.

The power supplies should be turned OFF for at least 20 – 30 seconds in order to discharge all internal bias supplies and reset the soft start circuitry of the individual power supplies.

**Auto\_restart:** Auto-restart is the default configuration for recovering from over-current and over-temperature shutdowns.

An overvoltage shutdown is followed by three attempted restarts, each restart delayed 1 second, within a 1 minute window. If within the 1 minute window three attempted restarts failed, the unit will latch OFF. If less than 3 shutdowns occur within the 1 minute window then the count for latch OFF resets and the 1 minute window starts all over again.

**Status\_word (79):** returns two bytes of information. The upper byte bit functionality is tabulated in the Status\_word section. The lower byte bit functionality is identical to Status\_byte.

**Fan\_speed (3B):** Fan speed can be controlled either by changing the RPM or duty cycle via register 3B. Selection of RPM or duty cycle control is accomplished by bit 6 of the FAN\_CONFIG\_1\_2 (3A) command. The default mode is xxxx. The speed of the fan cannot be reduced below what the power supply requires for its operation. The number represented in register D6 is an unsigned number, it is not in linear format.

**Mfr\_ID (99):** Manufacturer in ASCII – 5 characters maximum, General Electric – Critical Power represented as, GE-CP

**Mfr-revision (9B):** Total 4 bytes

Each byte is partitioned into high and low nibbles.

Example: FF is read as 16.16  
11 is read as 1.1

Series	Hardware Rev	Primary μC	Secondary μC

**Mfr\_serial (9E):** Product serial number includes the manufacturing date, manufacturing location in up to 15 characters. For example:

13KZ51018193xxx, is decoded as;

13 – year of manufacture, 2013

KZ – manufacturing location, in this case Matamoros

51 – week of manufacture

018193xxx – serial #, mfr choice

note: if the additional xxx space is not utilized then F's are filled in, (i.e. 018193FFF), ensuring that the actual serial number is clearly identified.

**Invalid commands or data:** The power supply notifies the MASTER if a non-supported command has been sent or invalid data has been received. Notification is implemented by setting the appropriate STATUS and ALARM registers and setting the SMBAlert# flag. An invalid command always returns a value of 0 x 00.

## Control and Read accuracy:

The estimates below are believed to be reasonable under most operating conditions. However, these are typical numbers and not hard bound values that cannot be exceeded. In most nominal operating conditions the returned values are significantly better than these estimates.

FUNCTION	ACCURACY
Vout_command	± 3%
Vout_OV_fault_limit	± 3%
Iout_OC_warn_limit	± 4% of FL
OT_warn_limit	± 5°C <sup>8</sup>
Read_Vout	± 3%
Read_Iout	± 4% of FL
Read_temperature	± 5°C <sup>9</sup>

## EEPROM

The microcontroller has 96 bytes of EEPROM memory available for the system host.

Another separate EEPROM IC will provide another 128 bytes of memory with write protect feature.

## LEDs

Three LEDs are located on the front faceplate. When the LEDs are ON GREEN then input and output are normal.

When the FAULT\_LED is RED, then a fault condition exists and the power supply may not provide output power. The table below further defines these states:

<sup>8</sup> Accuracy is estimated near the shutdown point around 100°C. At lower temperatures the accuracy is much reduced.

<sup>9</sup> Accuracy is estimated near the shutdown point around 100°C. At lower temperatures the accuracy is much reduced.

## CAR1212DC series DC-DC converter

Input:  $-36V_{DC}$  to  $-75V_{DC}$ ; Output:  $12V_{DC}$  @ 1200W;  $3.3V_{DC}$  or  $5V_{DC}$  @ 1A

### Alarm Table

Test Condition		LED Indicator			Monitoring Signals			
		INPUT OK	DC OK	FAULT	FAULT	DC OK	INPUT OK	TEMP OK
1	Normal Operation	Green	Green	OFF	High	High	High	High
2	Low or NO INPUT	OFF	OFF	RED	Low	Low	Low	High
3	OVP	Green	OFF	RED	Low	Low	High	High
4	Over Current	Green	OFF	RED	Low	Low	High	High
5	Over Temp Fault	Green	OFF	RED	Low	Low	High	Low

Note: Test condition #2 has 2 modules working in parallel. One module is running and the other has no input.

# CAR1212DC series DC-DC converter

Input:  $-36V_{DC}$  to  $-75V_{DC}$ ; Output:  $12V_{DC}$  @ 1200W;  $3.3V_{DC}$  or  $5V_{DC}$  @ 1A

## Outline Drawing

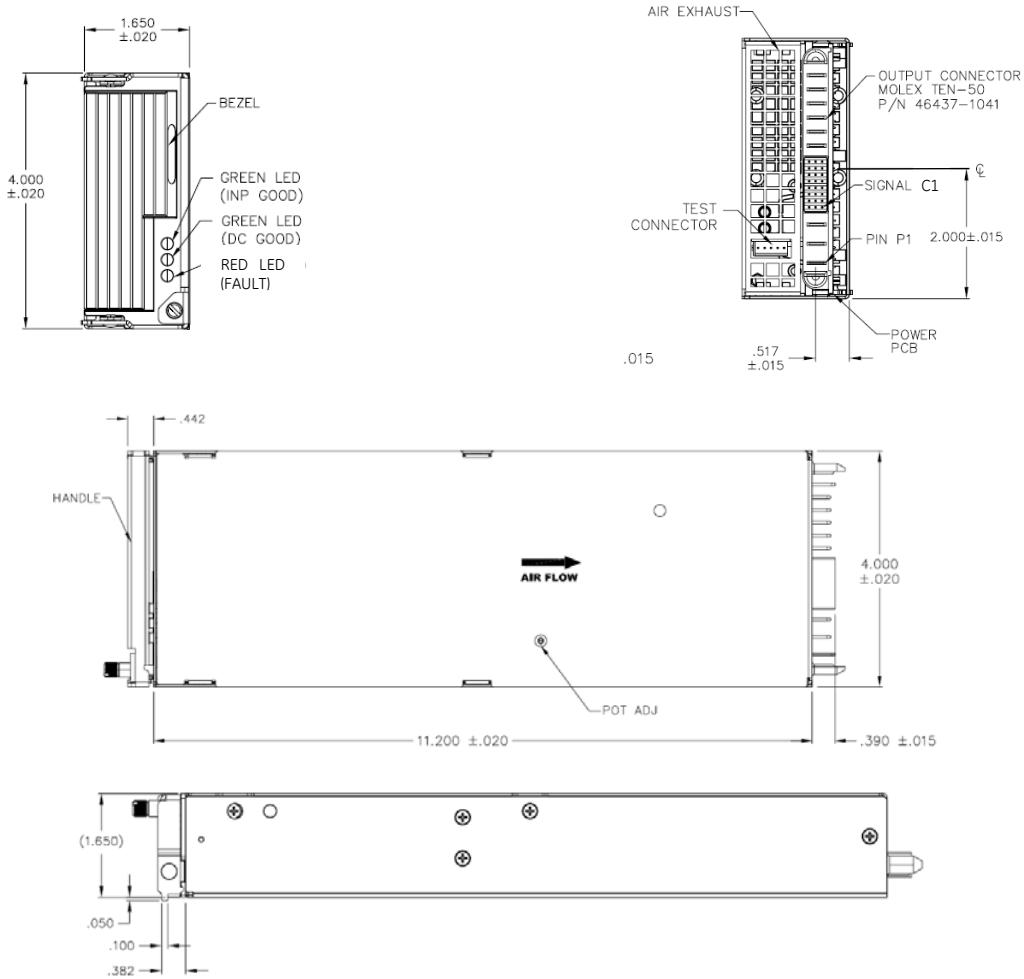

## Connector Pin Assignments

### Input/Output

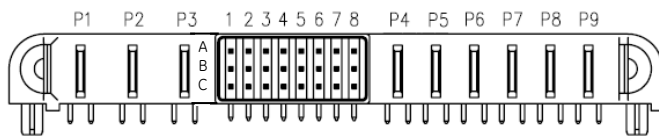

Molex P/N: 46437-1041  
Mating connector: Molex P/N: 46436-1041

Pin	Function	Pin	Function	Pin	Function	Pin	Function
A1	Vprog	B1	Write Protect (WP)	C1	Remote ON/OFF	P1	$V_{IN} (+)$
A2	PS Present	B2	DC OK	C2	SDA (I <sup>2</sup> C bus)	P2	$V_{IN} (-)$ [return]
A3	OVP Test Point	B3	INPUT OK	C3	SCL (I <sup>2</sup> C bus)	P3	GND
A4	Fault	B4	$V_{STDBY}$ return	C4	Vstb return		
A5	Remote Sense (+)	B5	SMBAlert (Interrupt)	C5	I <sup>2</sup> C Address (A2)	P4 – P6	+12V <sub>DC</sub>
A6	Temperature OK	B6	I Monitor (IMON)	C6	I <sup>2</sup> C Address (A1)	P7 – P9	Power Return
A7	N/C	B7	$V_{STDBY}$ [3.3V]	C7	I <sup>2</sup> C Address (A0)		
A8	Remote Sense (-)	B8	Enable (short pin)	C8	Ishare		

# CAR1212DC series DC-DC converter

Input: -36V<sub>DC</sub> to -75V<sub>DC</sub>; Output: 12V<sub>DC</sub> @ 1200W; 3.3V<sub>DC</sub> or 5 V<sub>DC</sub> @ 1A

## Ordering Information

Please contact your GE Energy Sales Representative for pricing, availability and optional features.

PRODUCT	DESCRIPTION	PART NUMBER
1200W converter	12V <sub>DC</sub> DC-DC converter w/Bezel, 3.3V <sub>aux</sub>	CAR1212DCBXXZ01A
1200W converter	12V <sub>DC</sub> DC-DC converter w/Bezel, 5V <sub>aux</sub>	CAR1212DCBX5Z01A

### PART NUMBER DEFINITION GUIDE EXAMPLE

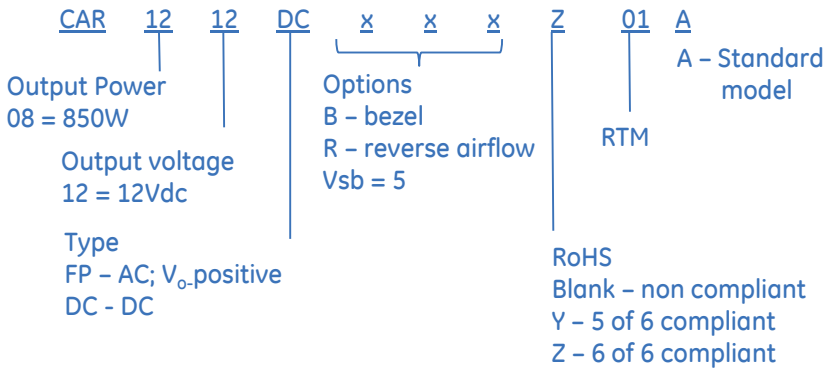

Contact Us  
 For more information, call us at  
 USA/Canada:  
**+1 888 546 3243**, or +1 972 244 9288  
 Asia-Pacific:  
 +86.021.54279977\*808  
 Europe, Middle-East and Africa:  
 +49.89.878067-280  
 India:  
 +91.80.28411633  
[www.ge.com/powerelectronics](http://www.ge.com/powerelectronics)

