

**ebm-papst St. Georgen GmbH & Co. KG**

Hermann-Papst-Straße 1

D-78112 St. Georgen

Phone +49 7724 81-0

Fax +49 7724 81-1309

info2@de.ebmpapst.com

www.ebmpapst.com

Nominal data

Type	5314 /2TD HHP	
Nominal voltage	VDC	24
Nominal voltage range	VDC	16 .. 36
Speed	min ⁻¹	7000
Power input	W	67
Min. ambient temperature	°C	-20
Max. ambient temperature	°C	70
Air flow	m ³ /h	490
Sound power level	B	8.1
Sound pressure level	dB(A)	75

ml = max. load · me = max. efficiency · rfa = running at free air · cs = customer specs · cu = customer unit
Subject to alterations



Technical features

Dimensions	140 x 140 x 51 mm
General description	<p>Particular design features:</p> <p>Very smooth running 3-phase fan drive.</p> <p>Very rigid compression curve for high air flow at high counterpressure.</p> <p>Low operating noise level at high counterpressure.</p> <p>Standard with PWM control input and speed signal.</p> <p>Other inputs and outputs on request.</p> <p>General features:</p> <p>Materials: Housing made of aluminium, impeller made of fibreglass-reinforced PA; housing with grounding lug for M4 x 8 screw (Torx).</p> <p>Protected against reverse polarity and locking.</p> <p>Connection via single strands AWG 20 and AWG 22, TR 64, bared and tin-plated.</p> <p>Inlet over bars. Direction of rotation counter-clockwise seen on rotor.</p> <p>Mass: 900 g.</p>
Direction of rotation	Counterclockwise, looking at rotor
Direction of air flow	Inlet over bars
Bearing	Ball bearings
Lifetime L10 at 40 °C	62500 h
Lifetime L10 at maximum temperature	30000 h
Mass	0.900 kg
Housing material	Aluminum. Housing with grounding lug for screw M4 x 8 (TORX).
Material of impeller	Fiberglass-reinforced PA plastic
Motor protection	Protected against reverse polarity and locking.

Product drawing

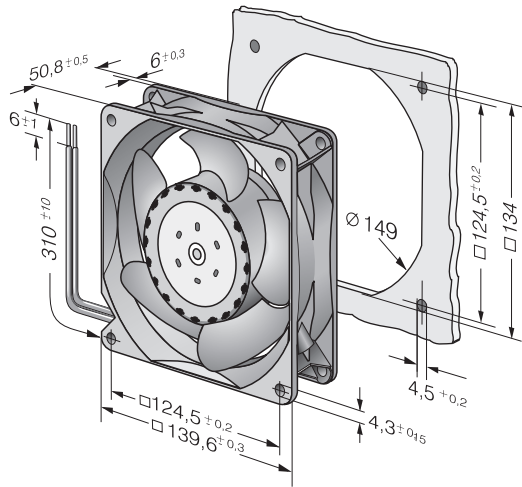

Charts: Air flow

