

RoHS Compliant Product
A suffix of "-C" specifies halogen free

DESCRIPTION

The SSE07N80SL is the highest performance trench N-ch MOSFETs with extreme high cell density , which provide excellent $R_{DS(on)}$ and gate charge for most of the synchronous buck converter applications .

FEATURES

- Advanced high cell density Trench technology
- Super Low Gate Charge
- Excellent CdV/dt effect decline
- 100% EAS Guaranteed
- Green Device Available

TO-220P

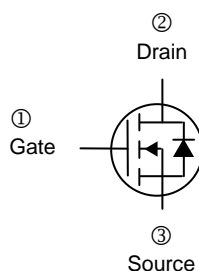
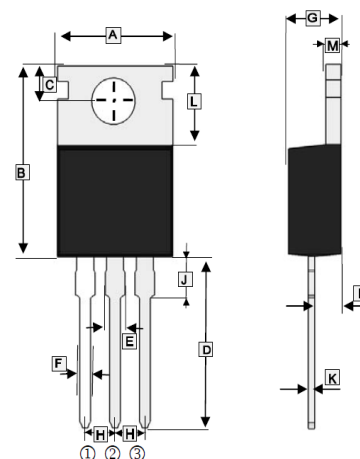

REF.	Millimeter		REF.	Millimeter	
	Min.	Max.		Min.	Max.
A	9.3	10.6	H	2.54	BCS.
B	14.2	16.5	I	1.8	2.9
C	2.7 BSC.		J	2.6	3.95
D	12.6	14.7	K	0.3	0.6
E	1.0	1.8	L	5.8	7.0
F	0.4	1.0	M	1.2	1.45
G	3.6	4.8			

ABSOLUTE MAXIMUM RATINGS ($T_A=25^\circ\text{C}$ unless otherwise specified)

Parameter	Symbol	Rating	Unit
Drain-Source Voltage	V_{DS}	800	V
Gate-Source Voltage	V_{GS}	± 30	V
Continuous Drain Current	I_D	$T_C=25^\circ\text{C}$	7
		$T_C=100^\circ\text{C}$	4.4
Pulsed Drain Current	I_{DM}	28	A
Total Power Dissipation	P_D	$T_C=25^\circ\text{C}$	154
		Derate above 25°C	1.23
Single Pulse Avalanche Energy ¹	E_{AS}	534	mJ
Operating Junction and Storage Temperature Range	T_J, T_{STG}	-55~150	$^\circ\text{C}$
Thermal Resistance Rating			
Maximum Thermal Resistance Junction-Ambient	$R_{\theta JA}$	62.5	$^\circ\text{C} / \text{W}$
Maximum Thermal Resistance Junction-Case	$R_{\theta JC}$	0.81	$^\circ\text{C} / \text{W}$

Notes:

1. $L=30\text{mH}, I_{AS}=5.5\text{A}, V_{DD}=135\text{V}, R_G=20\Omega$, Starting $T_J=25^\circ\text{C}$

ELECTRICAL CHARACTERISTICS ($T_J = 25^\circ\text{C}$ unless otherwise specified)

Parameter	Symbol	Min.	Typ.	Max.	Unit	Teat Conditions
Static						
Drain-Source Breakdown Voltage	BV_{DSS}	800	-	-	V	$V_{GS}=0, I_D=250\mu\text{A}$
Gate-Threshold Voltage	$V_{GS(th)}$	2	-	4	V	$V_{DS}=V_{GS}, I_D=250\mu\text{A}$
Gate-Source Leakage Current	I_{GSS}	-	-	± 100	nA	$V_{GS}= \pm 30\text{V}$
Drain-Source Leakage Current	I_{DSS}	-	-	1	μA	$V_{DS}=800\text{V}, V_{GS}=0$
Static Drain-Source On-Resistance	$R_{DS(ON)}$	-	1.39	1.6	Ω	$V_{GS}=10\text{V}, I_D=3.5\text{A}$
Total Gate Charge ^{1,2}	Q_g	-	23.27	-	nC	$I_D=7\text{A}$ $V_{DS}=640\text{V}$ $V_{GS}=10\text{V}$
Gate-Source Charge ^{1,2}	Q_{gs}	-	6.98	-		
Gate-Drain Change ^{1,2}	Q_{gd}	-	8.97	-		
Turn-on Delay Time ^{1,2}	$T_{d(on)}$	-	33.67	-	nS	$V_{DD}=400\text{V}$ $I_D=7\text{A}$ $R_G=25\Omega$
Rise Time ^{1,2}	T_r	-	71.67	-		
Turn-off Delay Time ^{1,2}	$T_{d(off)}$	-	63.33	-		
Fall Time ^{1,2}	T_f	-	35.33	-		
Input Capacitance	C_{iss}	-	23.27	-	pF	$V_{GS}=0$ $V_{DS}=25\text{V}$ $f=1.0\text{MHz}$
Output Capacitance	C_{oss}	-	6.98	-		
Reverse Transfer Capacitance	C_{rss}	-	8.97	-		
Source-Drain Diode						
Diode Forward Voltage	V_{SD}	-	-	1.4	V	$I_S=7\text{A}, V_{GS}=0$
Continuous Source Current	I_S	-	-	7	A	Integral Reverse P-N Junction Diode in the MOSFET
Pulsed Source Current	I_{SM}	-	-	28	A	
Reverse Recovery Time ¹	T_{rr}	-	590.27	-	ns	$I_S=7\text{A}, V_{GS}=0,$ $di_f/dt=100\text{A}/\mu\text{S}$
Reverse Recovery Charge ¹	Q_{rr}	-	3.93	-	μC	

Notes:

1. Pulse Test: Pulse width $\leq 300\mu\text{S}$, Duty cycle $\leq 2\%$
2. Essentially independent of operating temperature.

CHARACTERISTIC CURVES

Figure 1. On-Region Characteristics

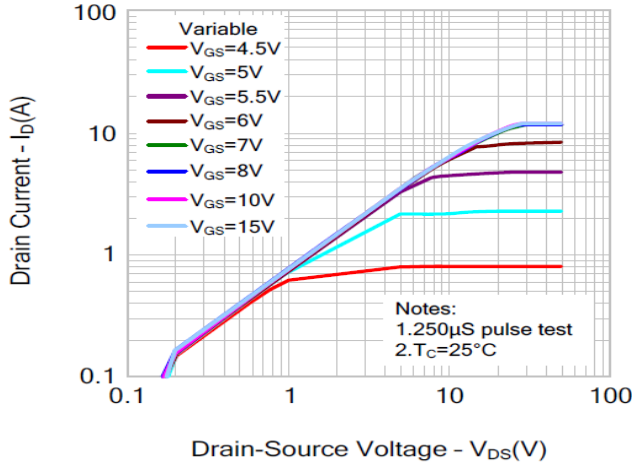

Figure 2. Transfer Characteristics

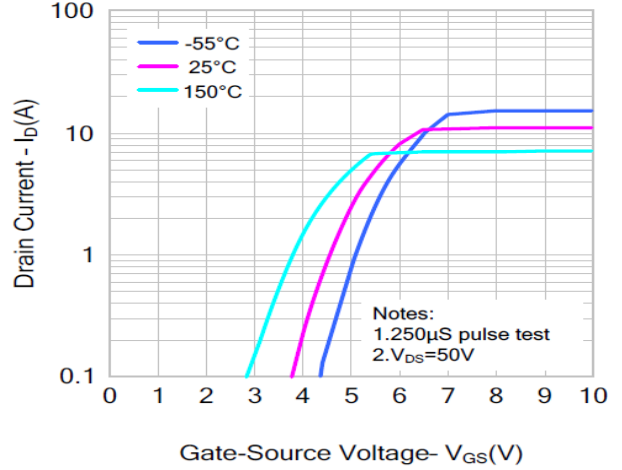

Figure 3. On-Resistance Variation vs. Drain Current and Gate Voltage

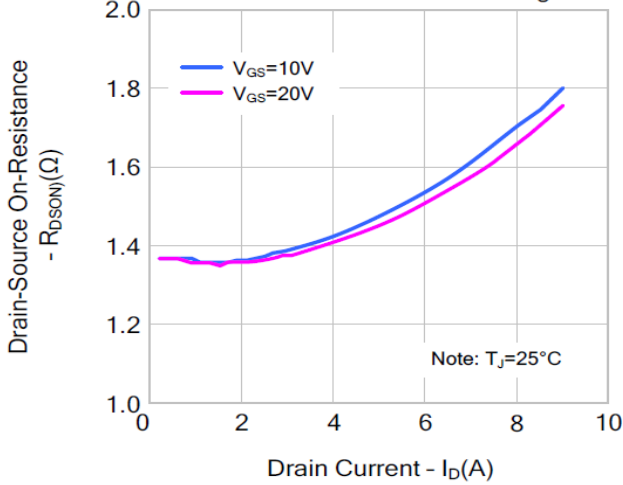

Figure 4. Body Diode Forward Voltage Variation vs. Source Current and Temperature

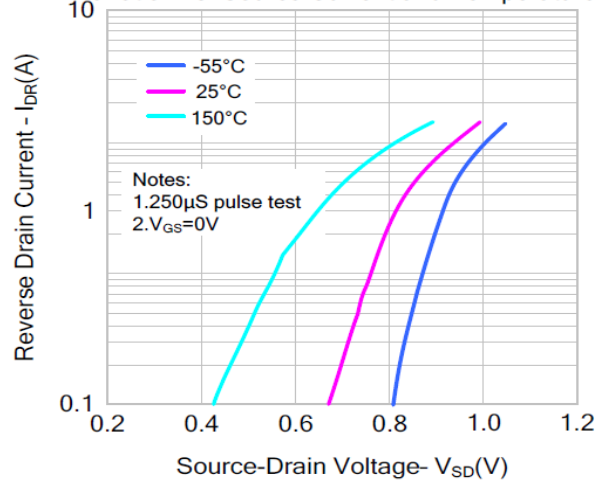

Figure 5. Capacitance Characteristics

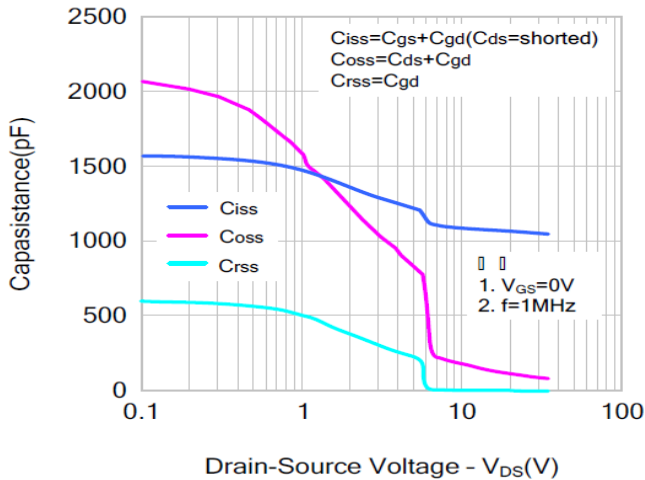
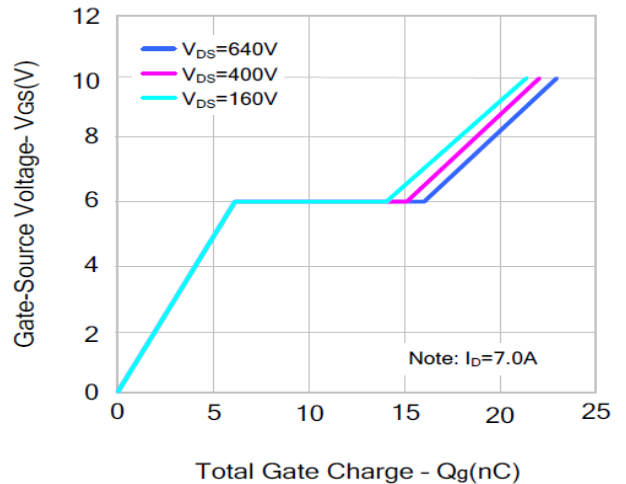

Figure 6. Gate Charge Characteristics



CHARACTERISTIC CURVES

Figure 7. Breakdown Voltage Variation vs. Temperature

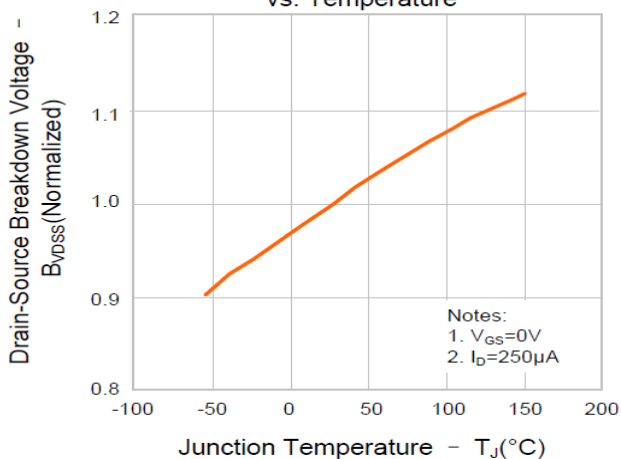

Figure 8. On-resistance Variation vs. Temperature

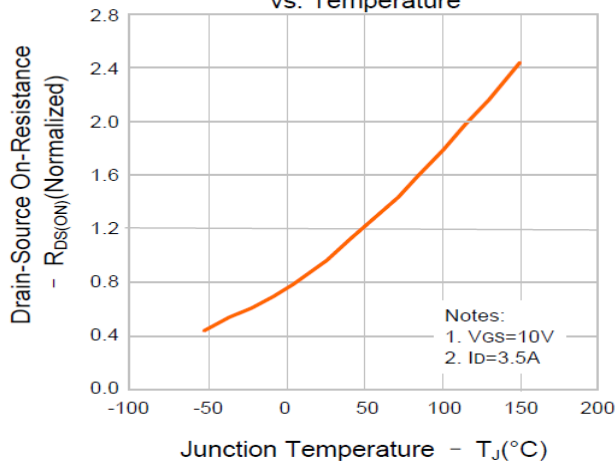

Figure 9 Max. Safe Operating Area

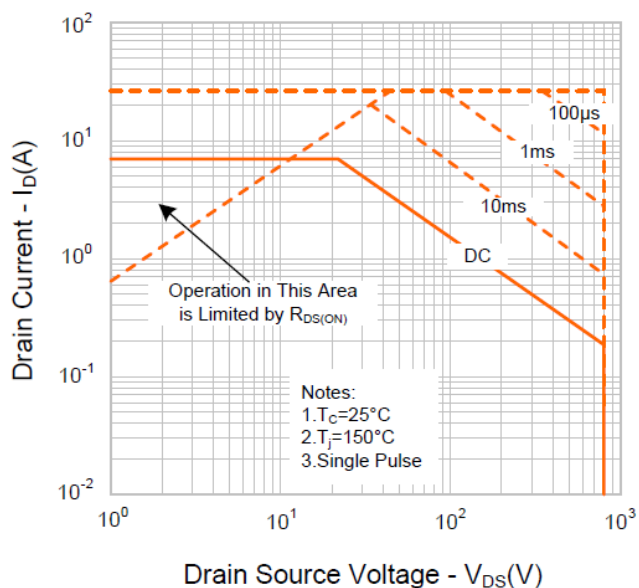
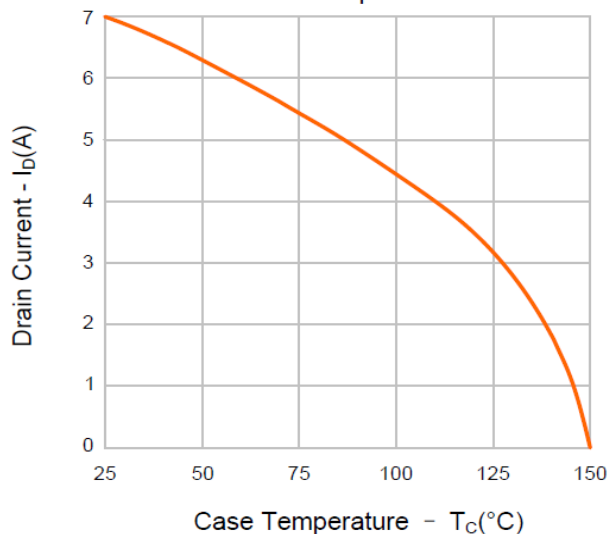
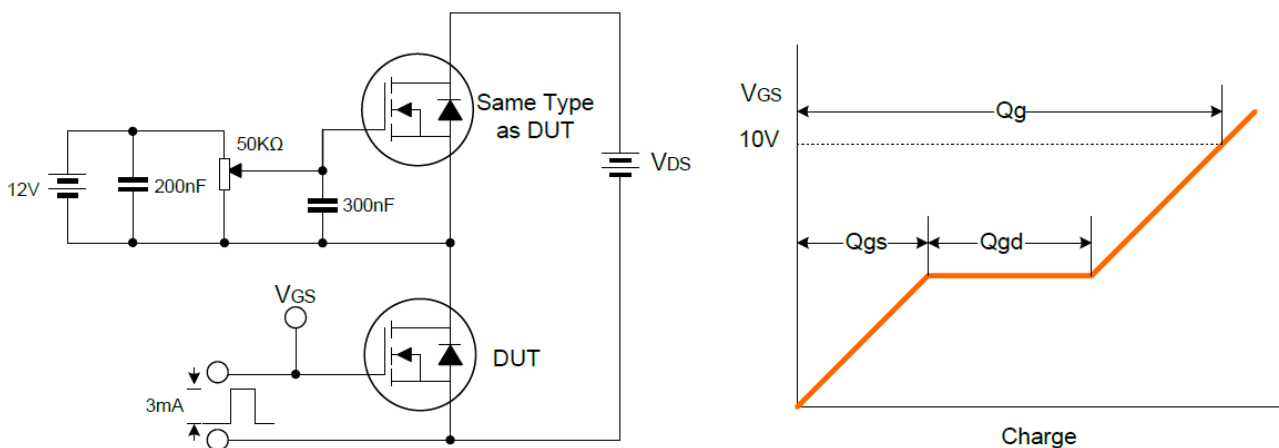

Figure 10. Maximum Drain Current vs. Case Temperature



TYPICAL TEST CURVES

Gate Charge Test Circuit & Waveform



Resistive Switching Test Circuit & Waveform

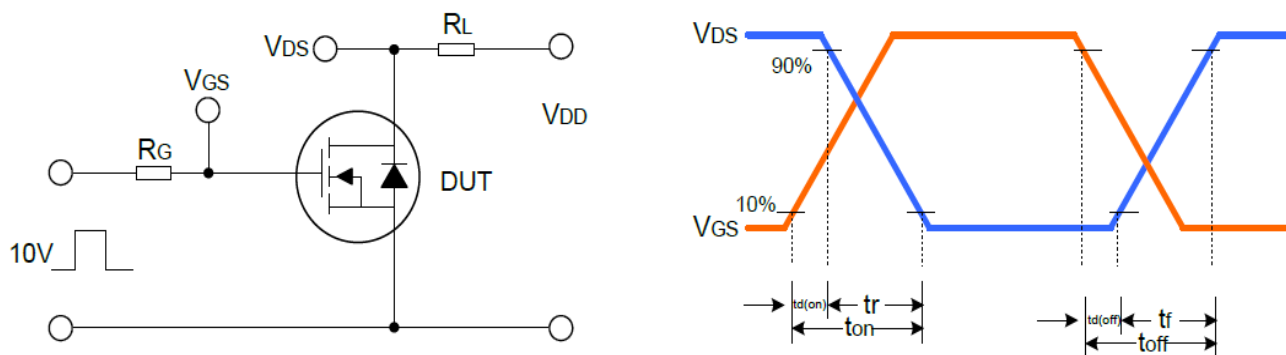

Unclamped Inductive Switching Test Circuit & Waveform

