



128K x 16 Static RAM

Features

- **Low voltage range:**
— 1.8V–3.3V
- **Ultra-low active, standby power**
- **Easy memory expansion with \overline{CE} and \overline{OE} features**
- **TTL-compatible inputs and outputs**
- **Automatic power-down when deselected**
- **CMOS for optimum speed/power**

Functional Description

The CY62136V is a high-performance CMOS static RAM organized as 131,072 words by 16 bits. This device features advanced circuit design to provide ultra-low active current. This is ideal for providing More Battery Life (MoBL™) in portable applications such as cellular telephones. The device also has an automatic power-down feature that significantly reduces power consumption by 99% when addresses are not toggling. The device can also be put into standby mode when deselected (\overline{CE} HIGH). The input/output pins (I/O_0 through I/O_{15}) are placed in a high-impedance state when: deselected (\overline{CE} HIGH), outputs are disabled (\overline{OE} HIGH), \overline{BHE} and \overline{BLE} are

disabled (\overline{BHE} , \overline{BLE} HIGH), or during a write operation (\overline{CE} LOW, and \overline{WE} LOW).

Writing to the device is accomplished by taking chip enable (\overline{CE}) and write enable (\overline{WE}) inputs LOW. If byte low enable (\overline{BLE}) is LOW, then data from I/O pins (I/O_0 through I/O_7), is written into the location specified on the address pins (A_0 through A_{16}). If byte high enable (\overline{BHE}) is LOW, then data from I/O pins (I/O_8 through I/O_{15}) is written into the location specified on the address pins (A_0 through A_{16}).

Reading from the device is accomplished by taking chip enable (\overline{CE}) and output enable (\overline{OE}) LOW while forcing the write enable (\overline{WE}) HIGH. If byte low enable (\overline{BLE}) is LOW, then data from the memory location specified by the address pins will appear on I/O_0 to I/O_7 . If byte high enable (\overline{BHE}) is LOW, then data from memory will appear on I/O_8 to I/O_{15} . See the Truth Table at the back of this datasheet for a complete description of read and write modes.

The CY62136V MoBL SRAM has an extremely wide operating voltage range. The datasheet has been specified to accurately describe the device behavior at three common voltage ranges (3.3–2.7, 2.7–2.3, 2.3–1.8).

The CY62136V is available in 48-ball FBGA and standard 44-pin TSOP Type II (forward pinout) packaging.

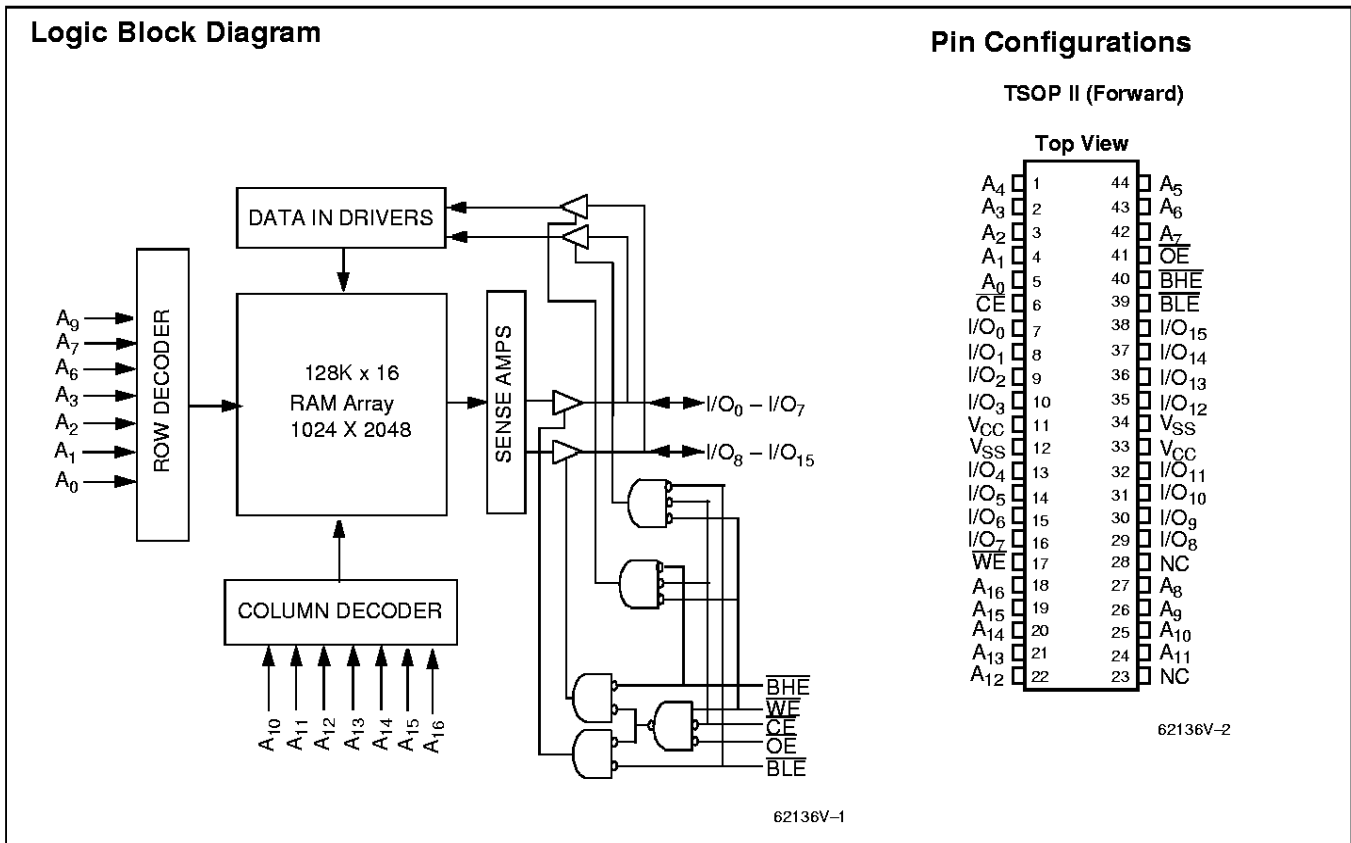



Pin Configuration (continued)

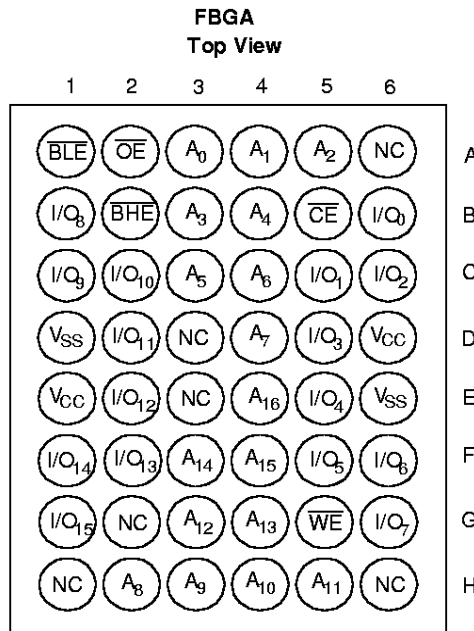

62136V-3

Maximum Ratings

(Above which the useful life may be impaired. For user guidelines, not tested.)

Storage Temperature -65°C to +150°C

Ambient Temperature with Power Applied 55°C to +125°C

Supply Voltage to Ground Potential (Pin 28 to Pin 14)..... -0.5V to +4.6V

DC Voltage Applied to Outputs in High Z State^[1] -0.5V to V_{CC} + 0.5V

DC Input Voltage^[1] -0.5V to V_{CC} + 0.5V

Output Current into Outputs (LOW) 20 mA

Static Discharge Voltage >2001V (per MIL-STD-883, Method 3015)

Latch-Up Current >200 mA

Operating Range

Range	Ambient Temperature	V _{CC}
Industrial	-40°C to +85°C	1.8V to 3.3V

Product Portfolio

Product	V _{CC} Range			Speed	Power Dissipation (Commercial)			
	Min.	Typ. ^[2]	Max.		Operating (I _{CC})		Standby (I _{SB2})	
					Typ. ^[2]	Maximum	Typ. ^[2]	Maximum
CY62136V	2.7V	3.0V	3.3V	70 ns	7	15 mA	1 μA	15 μA
CY62136V	2.3V	2.5V	2.7V	85 ns	5	10 mA		12 μA
CY62136V	1.8V	2.0V	2.3V	100 ns	3	7 mA		10 μA

Shaded areas contain advanced information



Electrical Characteristics Over the Operating Range

Parameter	Description	Test Conditions		CY62136V			Unit
				Min.	Typ. ^[2]	Max.	
V _{OH}	Output HIGH Voltage	I _{OH} = -1.0 mA	V _{CC} = 2.7V	2.4			V
		I _{OH} = -0.1 mA	V _{CC} = 2.3V	2.0			V
		I _{OH} = -0.1 mA	V _{CC} = 1.8V	1.5			V
V _{OL}	Output LOW Voltage	I _{OL} = 2.1 mA	V _{CC} = 2.7V			0.4	V
		I _{OL} = 0.1 mA	V _{CC} = 2.3V			0.4	V
		I _{OL} = 0.1 mA	V _{CC} = 1.8V			0.2	V
V _{IH}	Input HIGH Voltage		V _{CC} = 3.3V	2.2		V _{CC} + 0.5V	V
			V _{CC} = 2.7V	2.0		V _{CC} + 0.5V	V
			V _{CC} = 2.3V	1.4		V _{CC} + 0.3V	V
V _{IL}	Input LOW Voltage		V _{CC} = 2.7V	-0.5		0.8	V
			V _{CC} = 2.3V	-0.5		0.6	V
			V _{CC} = 1.8V	-0.5		0.4	V
I _{IX}	Input Load Current	GND ≤ V _I ≤ V _{CC}		-1	±1	+1	µA
I _{OZ}	Output Leakage Current	GND ≤ V _O ≤ V _{CC} , Output Disabled		-1	+1	+1	µA
I _{CC}	V _{CC} Operating Supply Current	I _{OUT} = 0 mA, f = f _{MAX} = 1/t _{RC} , CMOS levels	V _{CC} = 3.3V		7	15	mA
			V _{CC} = 2.7V		5	10	mA
			V _{CC} = 2.3V		3	7	mA
		I _{OUT} = 0 mA, f = 1MHz, CMOS Levels		1	2	mA	
I _{SB1}	Automatic CE Power-Down Current—CMOS Inputs	$\overline{CE} \geq V_{CC} - 0.3V$, V _{IN} ≥ V _{CC} - 0.3V or V _{IN} ≤ 0.3V, f = f _{MAX}				100	µA
I _{SB2}	Automatic CE Power-Down Current—CMOS Inputs	$\overline{CE} \geq V_{CC} - 0.3V$, V _{IN} ≥ V _{CC} - 0.3V or V _{IN} ≤ 0.3V, f = 0		L	1	50	µA
			V _{CC} = 3.3V	LL	1	15	µA
			V _{CC} = 2.7V	LL	1	12	µA
			V _{CC} = 2.3V	LL	1	10	µA

Shaded areas contain advanced information.

Capacitance^[3]

Parameter	Description	Test Conditions	Max.	Unit
C _{IN}	Input Capacitance	T _A = 25°C, f = 1 MHz, V _{CC} = 3.0V	6	pF
C _{OUT}	Output Capacitance		8	pF

Notes:

- V_{IL}(min) = -2.0V for pulse durations less than 20 ns.
- Typical values are included for reference only and are not guaranteed or tested. Typical values are measured at V_{CC} = V_{CC} Typ, T_A = 25°C.
- Tested initially and after any design or process changes that may affect these parameters.

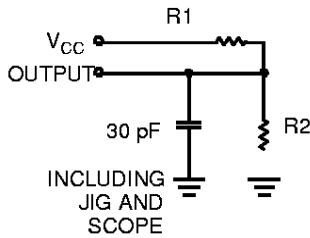
AC Test Loads and Waveforms

62136V-4

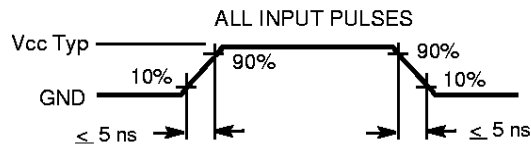

62136V-5

Equivalent to: THÉVENIN EQUIVALENT



Parameters	3.0V	2.5V	2.0V	UNIT
R1	1105	16670	15294	Ohms
R2	1550	15380	11300	Ohms
R_{TH}	645	8000	6500	Ohms
V_{TH}	1.75V	1.2V	0.85V	Volts

Shaded areas contain advanced information.

Data Retention Characteristics (Over the Operating Range)

Parameter	Description	Conditions ^[5]	Min.	Typ. ^[2]	Max.	Unit
V_{DR}	V_{CC} for Data Retention		1.0		3.3	V
I_{CCDR}	Data Retention Current	$V_{CC} = 1.0V$ $\overline{CE} \geq V_{CC} - 0.3V$, $V_{IN} \geq V_{CC} - 0.3V$ or $V_{IN} \leq 0.3V$ No input may exceed $V_{CC} + 0.3V$	L/ LL	0.1	1	μA μA
$t_{CDR}^{[3]}$	Chip Deselect to Data Retention Time		0			ns
t_R	Operation Recovery Time		t_{RC}			ns

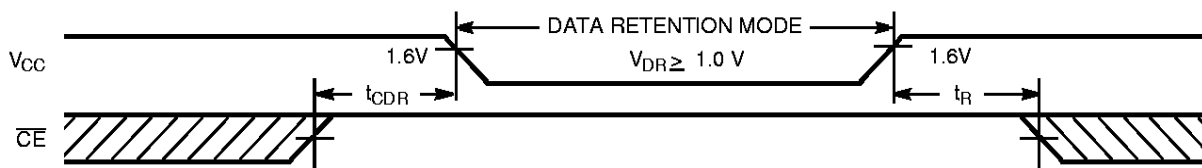
Data Retention Waveform

62128V-6

Switching Characteristics Over the Operating Range^[4]

Parameter	Description	(2.7V–3.3V Operation)		(2.3V–2.7V Operation)		(1.8V–2.3V Operation)		Unit
		Min.	Max.	Min.	Max.	Min.	Max.	
READ CYCLE								
t_{RC}	Read Cycle Time	70		85		100		ns
t_{AA}	Address to Data Valid		70		85		100	ns
t_{OHA}	Data Hold from Address Change	10		10		10		ns
t_{ACE}	\overline{CE} LOW to Data Valid		70		85		100	ns
t_{DOE}	\overline{OE} LOW to Data Valid		35		50		75	ns
t_{LZOE}	\overline{OE} LOW to Low Z ^[5]	5		5		5		ns
t_{HZOE}	\overline{OE} HIGH to High Z ^[5, 6]		25		35		50	ns
t_{LZCE}	\overline{CE} LOW to Low Z ^[5]	10		10		10		ns
t_{HZCE}	\overline{CE} HIGH to High Z ^[5, 6]		25		35		50	ns
t_{PU}	\overline{CE} LOW to Power-Up	0		0		0		ns
t_{PD}	\overline{CE} HIGH to Power-Down		70		85		100	ns
WRITE CYCLE^[7, 8]								
t_{WC}	Write Cycle Time	70		85		100		ns
t_{SCE}	\overline{CE} LOW to Write End	60		75		90		ns
t_{AW}	Address Set-Up to Write End	60		75		90		ns
t_{HA}	Address Hold from Write End	0		0		0		ns
t_{SA}	Address Set-Up to Write Start	0		0		0		ns
t_{PWE}	\overline{WE} Pulse Width	50		65		80		ns
t_{SD}	Data Set-Up to Write End	30		50		60		ns
t_{HD}	Data Hold from Write End	0		0		0		ns
t_{HZWE}	\overline{WE} LOW to High Z ^[5, 6]		25		35		50	ns
t_{LZWE}	\overline{WE} HIGH to Low Z ^[5]	10		10		10		ns

Shaded areas contain advanced information.

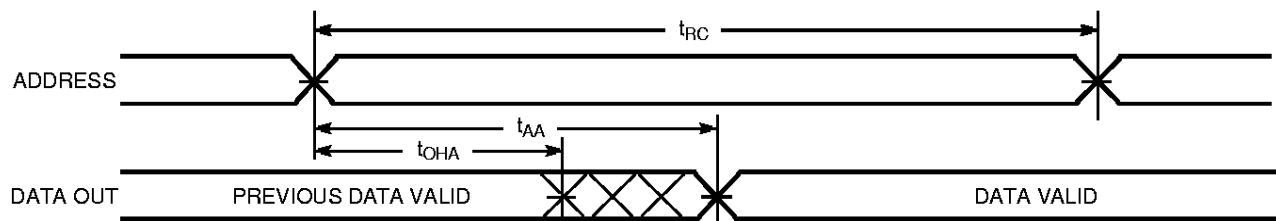
Switching Waveforms
Read Cycle No. 1^[9, 10]

62136V-7

Notes:

- Test conditions assume signal transition time of 5 ns or less, timing reference levels of 1.5V, input pulse levels of 0 to V_{CC} typ., and output loading of the specified I_{OL}/I_{OH} and 30 pF load capacitance.
- At any given temperature and voltage condition, t_{HZOE} is less than t_{LZOE} , t_{HZCE} is less than t_{LZCE} , and t_{HZWE} is less than t_{LZWE} for any given device.
- t_{HZOE} , t_{HZCE} , and t_{HZWE} are specified with $C_L = 5$ pF as in part (b) of AC Test Loads. Transition is measured ± 500 mV from steady-state voltage.
- The internal write time of the memory is defined by the overlap of \overline{CE} LOW and \overline{WE} LOW. Both signals must be LOW to initiate a write and either signal can terminate a write by going HIGH. The data input set-up and hold timing should be referenced to the rising edge of the signal that terminates the write.
- The minimum write cycle time for write cycle #3 (\overline{WE} controlled, \overline{OE} LOW) is the sum of t_{HZWE} and t_{SD} .
- Device is continuously selected. \overline{OE} , $\overline{CE} = V_{IL}$.
- \overline{WE} is HIGH for read cycle.

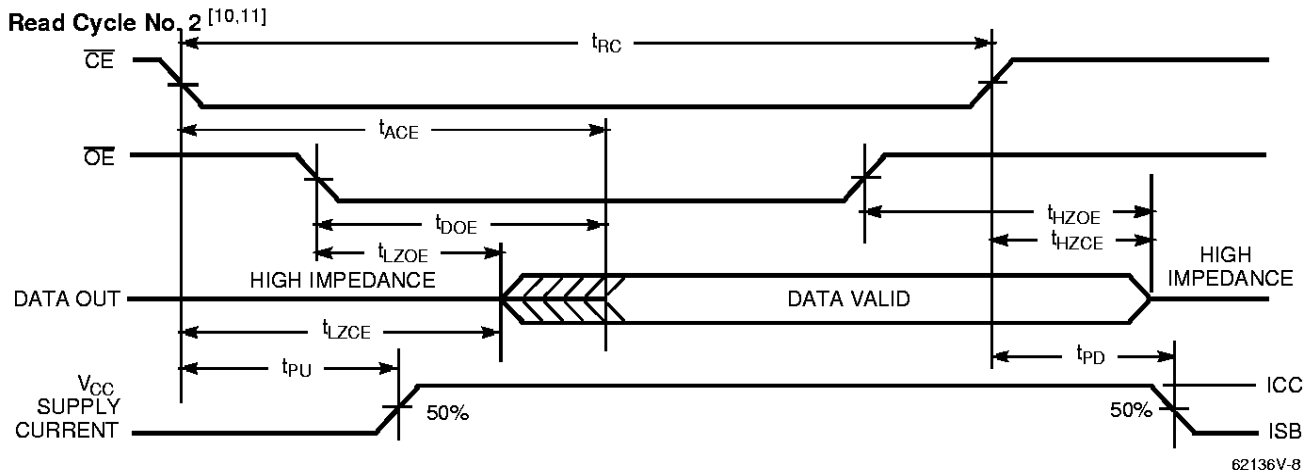
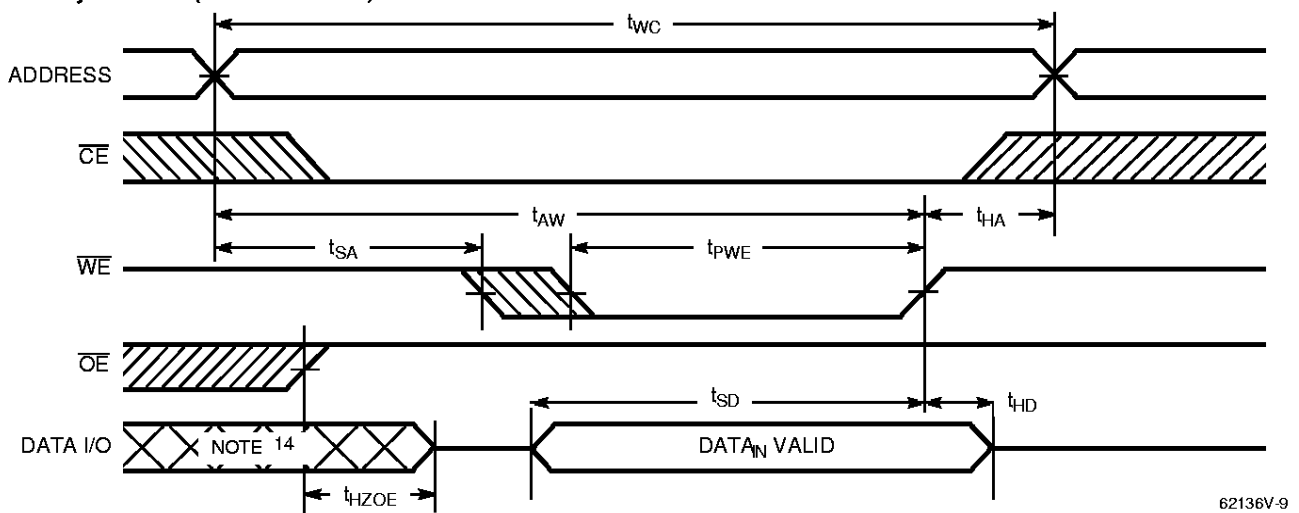
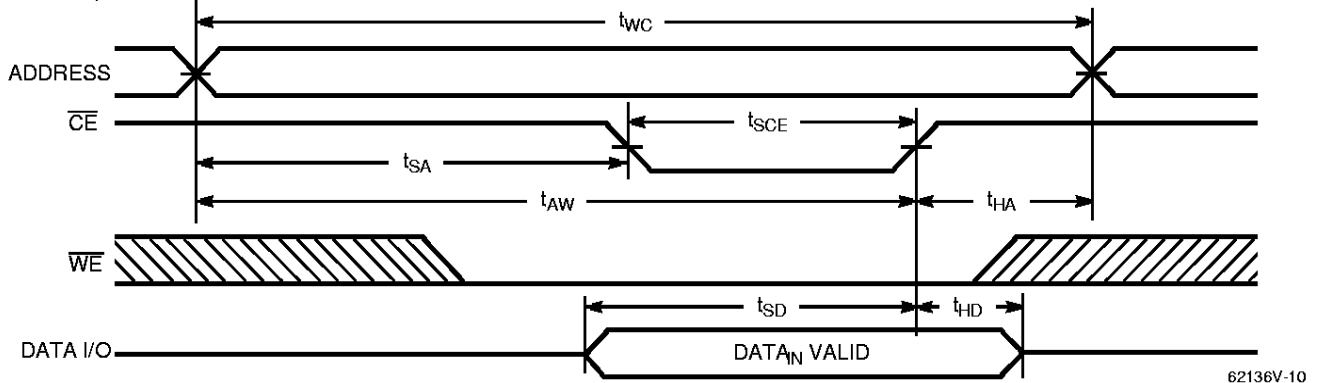
Switching Waveforms (continued)

Write Cycle No. 1 (WE Controlled) ^[7,12,13]

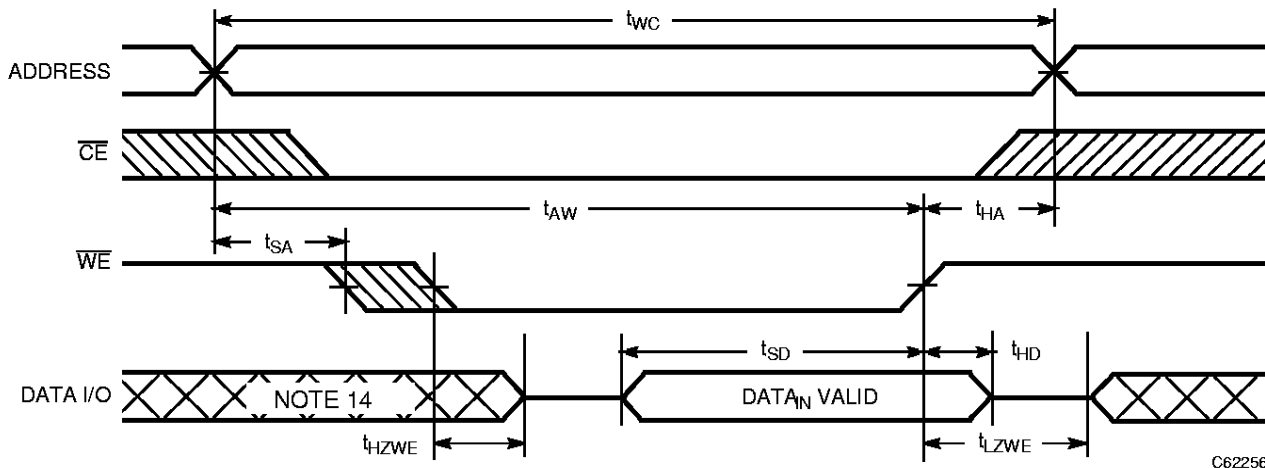
Write Cycle No. 2 (\overline{CE} Controlled) ^[7,12,13]

Notes:

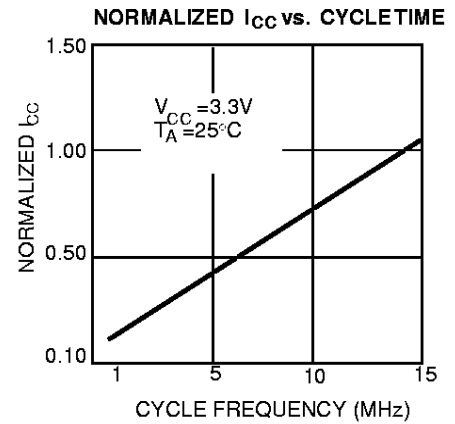
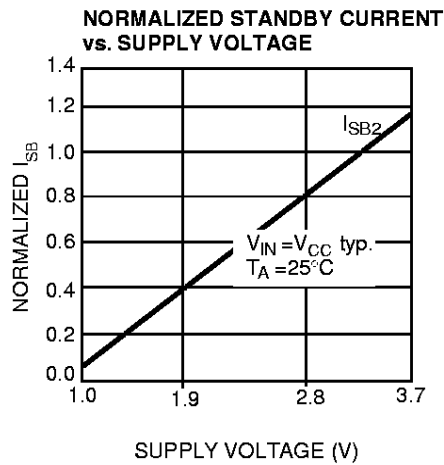
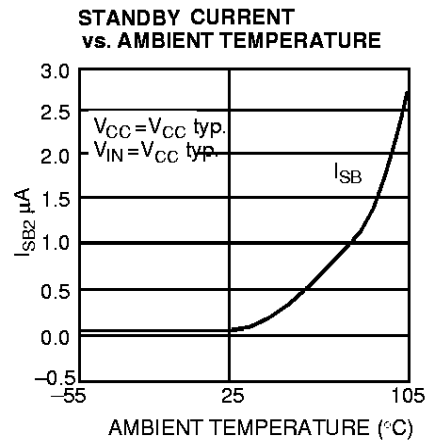
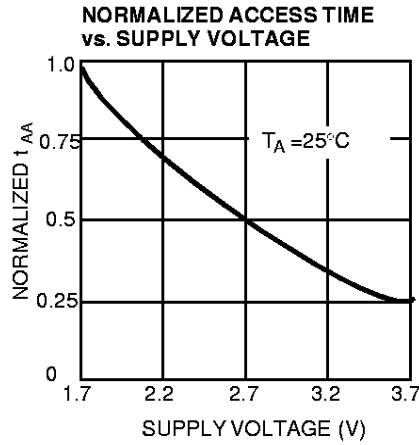
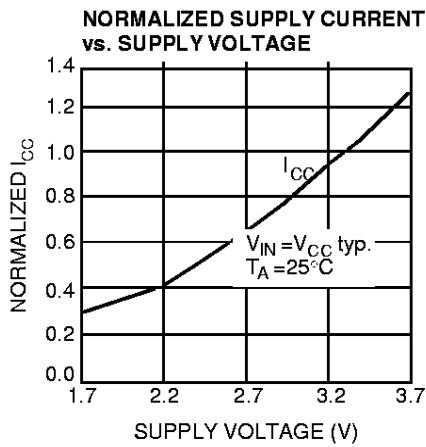
11. Address valid prior to or coincident with \overline{CE} transition LOW.
12. Data I/O is high impedance if $OE = V_{IH}$.
13. If \overline{CE} goes HIGH simultaneously with WE HIGH, the output remains in a high-impedance state.
14. During this period, the I/Os are in output state and input signals should not be applied.

Switching Waveforms (continued)
Write Cycle No. 3 (\overline{WE} Controlled, \overline{OE} LOW) ^[8,13]

C62256-12

Typical DC and AC Characteristics

Truth Table

CE	WE	OE	Inputs/Outputs	Mode	Power
H	X	X	High Z	Deselect/Power-Down	Standby (I_{SB})
L	H	L	Data Out	Read	Active (I_{CC})
L	L	X	Data In	Write	Active (I_{CC})
L	H	H	High Z	Deselect, Output Disabled	Active (I_{CC})

Ordering Information

Speed (ns)	Ordering Code	Package Name	Package Type	Operating Range
70	CY62136V-70ZI	Z44	44 Pin TSOP II	Industrial
	CY62136V-70BAI	BA48	48 Ball Fine Pitch BGA	
	CY62136VLL-70ZI	Z44	44 Pin TSOP II	
	CY62136VLL-70BAI	BA48	485 Ball Fine Pitch BGA	

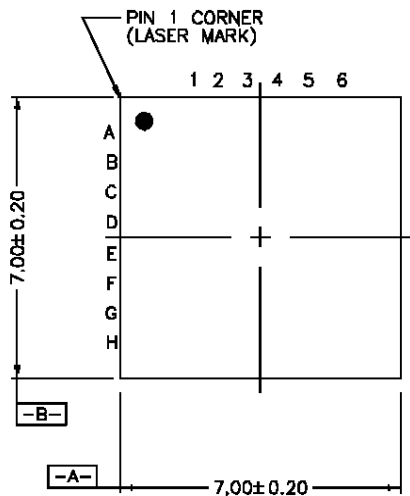
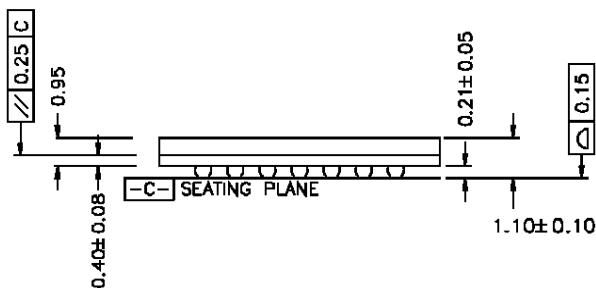
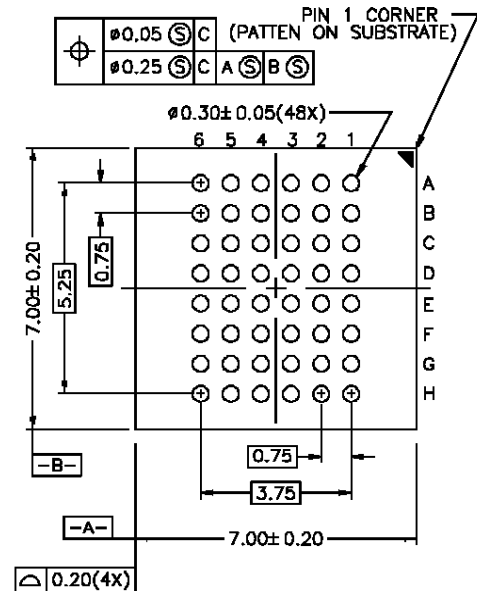
Shaded area contains advanced information.

Package Diagrams
48-Ball (7.00 mm x 7.00 mm) Mini-BGA BA48
TOP VIEW

BOTTOM VIEW

51-85096-A

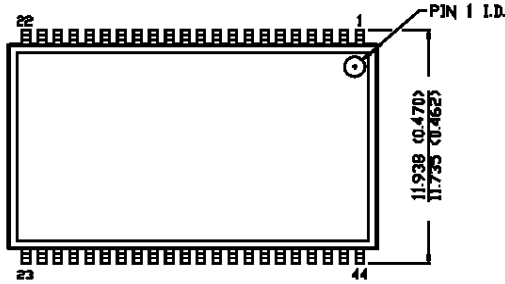
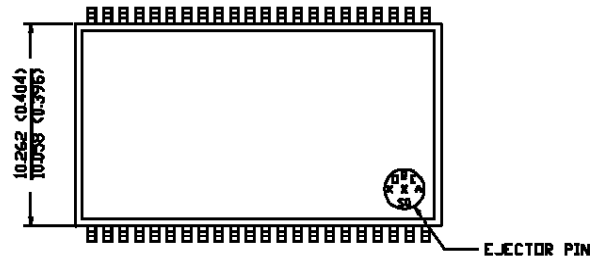
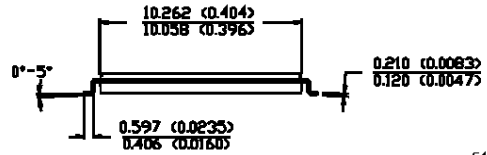
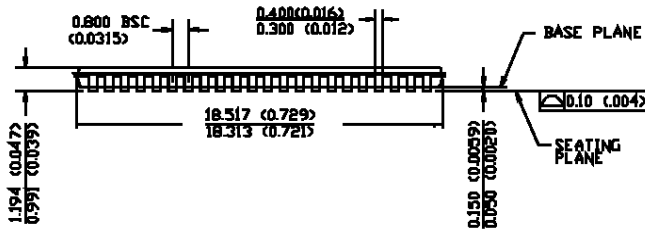
Package Diagrams (continued)
44-Pin TSOP II Z44

 DIMENSION IN MM (INCH)
 MAX
 MIN

TOP VIEW

BOTTOM VIEW

51-85087-A