

TOP VIEW

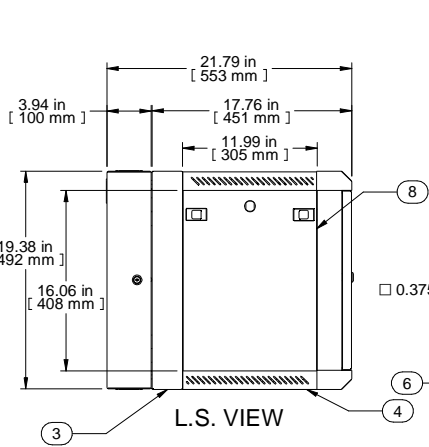

L.S. VIEW

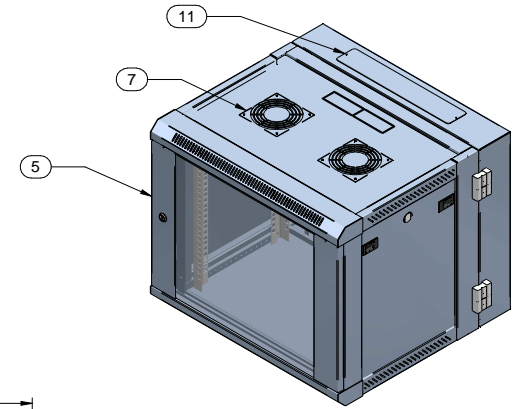
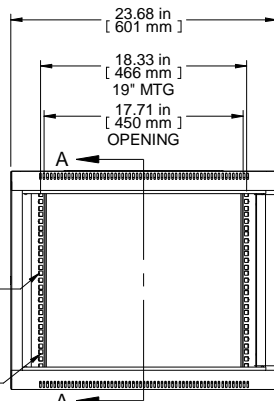

FRONT VIEW
DOOR REMOVED

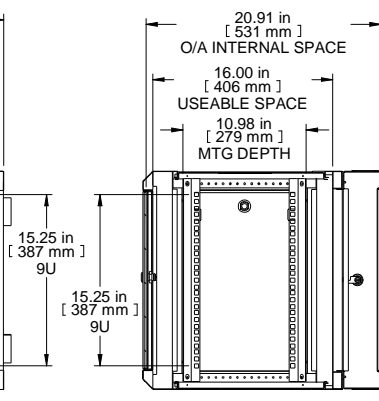

SECTION A-A

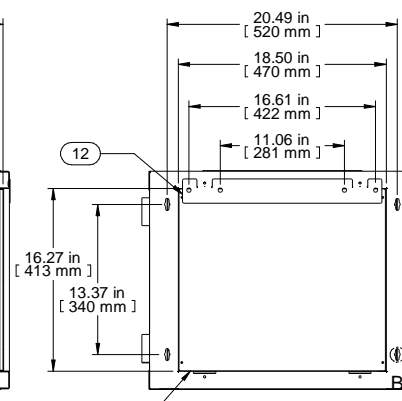

REAR VIEW

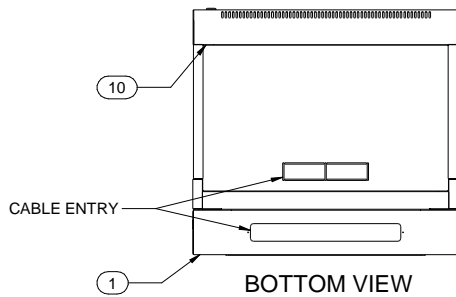

BOTTOM VIEW

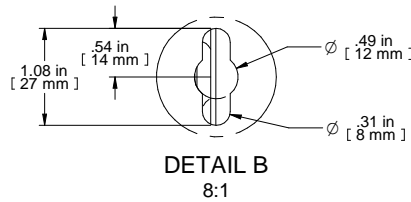

DETAIL B
8:1

Item Number	Title	Quantity
1	REAR FRAME	1
2	BACK PANEL	1
3	REAR SWING FRAME	1
4	SIDE SWING FRAME	2
5	FRONT DOOR ASSEMBLY	1
6	9U COMBINATION MOUNTING RAIL	4
7	FAN COVER	2
8	SIDE PANEL	2
9	TOP PANEL	1
10	BOTTOM PANEL	1
11	CABLE ENTRY COVER	2
12	WALL MOUNTING BRACKET	1

PART NUMBERS

SWCC1901521BK2 | PAINTED BLACK TEXTURED

NOTES

Shipped knockdown for ease & protection.

Data subject to change without notice. Isometric drawing not to scale.



www.hammondmfg.com

PART NO.

SWCC1901521