

Verpackt im Gurt nach DIN IEC 60286-3
 Tape on Reel Packaging according to DIN IEC 60286-3
 Verpackungseinheit: 220 Stück
 Packaging unit: 220 pcs

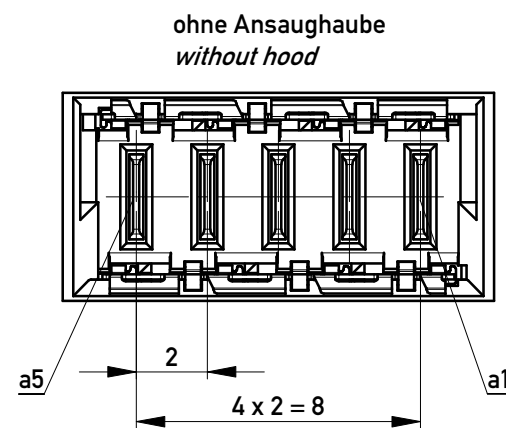

Abspulrichtung - Reel off Direction

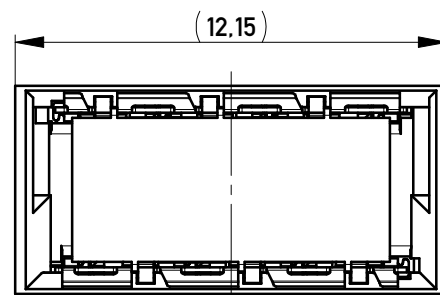
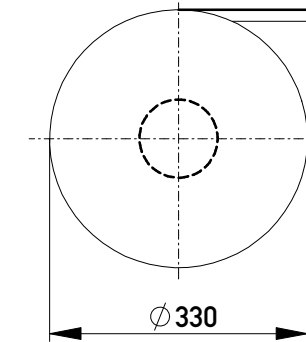
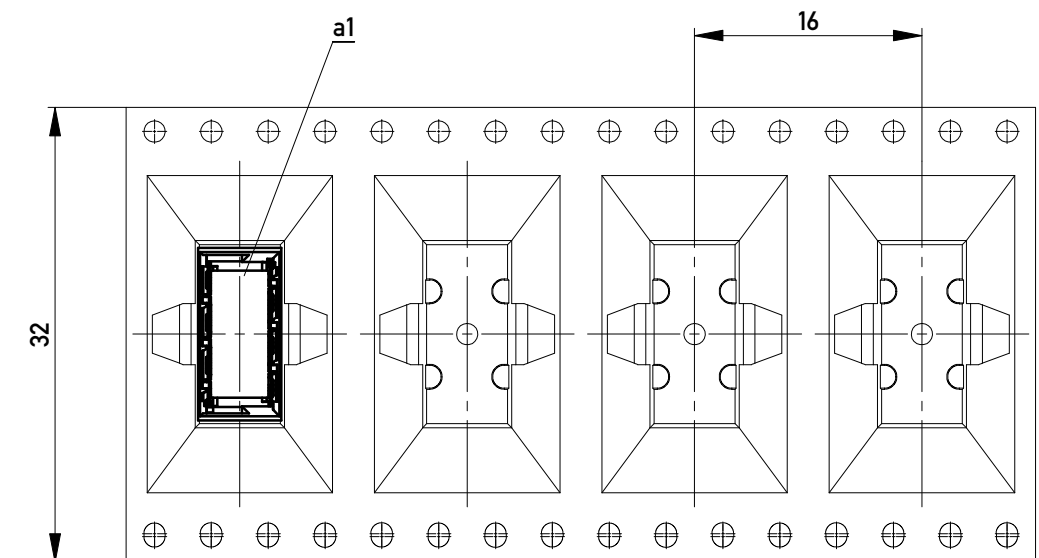

Leiterplatten-Layout Vorschlag / PCB-layout proposal

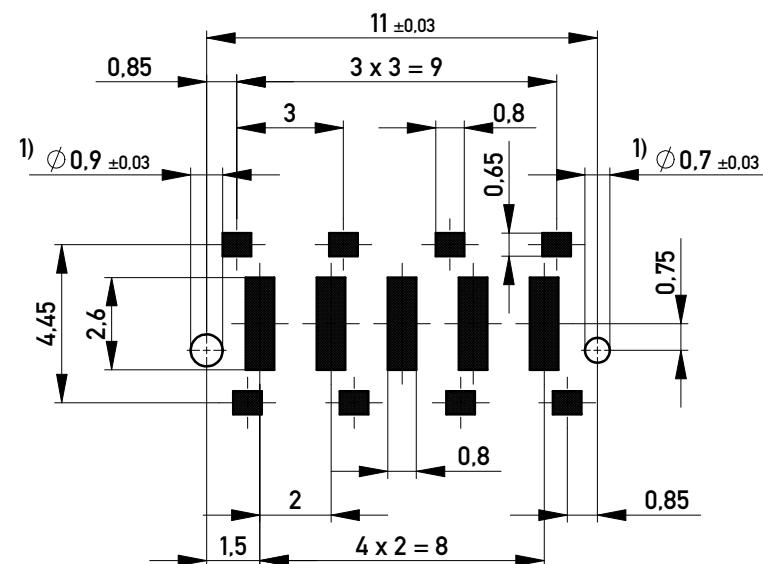

1) Durchmesser des Bohrers / drill tool

Anforderungsstufe 1
 Performance Level 1

Kontaktbereich vergoldet
 Mating Area gold plating

Anschlussbereich verzinkt 4-6 µm
 Terminal Area 4-6 µm tin plating

Koplanarität der Anschlüsse ≤ 0,1 mm
 Coplanarity Area of Termination ≤ 0,1 mm

Information: All rights reserved. Only for Information. To ensure that this is the latest version of this drawing, please contact one of the ERNI companies before using.	Tolerances All Dimensions in mm	Scale	5:1
		Designation	Messerleiste SMD, Powerm. 10mm Male Con. SMD, Powerm. 10mm
l	07.02.2014	www.ERNI.com	100500630001
Index	Date		Class
			K A3

Copyright by ERNI GmbH
 Proprietary notice pursuant to ISO 16016 to be observed.