

Dynex Semiconductor's range of Surface Acoustic Wave filters provide IF filtering for most current TV systems. The filters are designed for use in TV modulators and transposers, and are available without sound, with one sound channel, or with stereo sound.

FEATURES

- Filters for System B/G, I, M & K TV Standards
- Linear Phase Characteristics
- Low Amplitude and Group Delay Ripple
- Sidelobe Levels Better Than 50dB
- Hermetically Sealed Package

FILTER	SYSTEM	SOUND	REMARKS	PACKAGE STYLE
DW1401-G	B/G	None		A
DW1404-G	B/G	1		A
DW1406-G	B/G	None		A
DW1408-G	B/G	Stereo		A
DW1409-G	B/G	Stereo		D
DW1411-G	B/G			A
DW2501-G	B/G	None		A
DW1502-I	I	1		A
DW1503-I	I	1		A
DW1505-I	I	1		A
DW9231-I	I	1	NICAM Sound Filter	D
DW9232-I	I	None	NICAM Vision Filter	D
DW1603-M	M	None		D
DW1605-M	M	1		D
DW1701-K	K	None		A
DW1702-K	K	1		A

ELECTRICAL CHARACTERISTICS

Test Conditions (unless otherwise stated):
 Temperature = +23°C ±2°C
 Load and source impedances = 50Ω

SYSTEM B/G FILTERS	DW1401-G		DW1404-G		DW1406-G		DW1408-G		DW1409-G		DW1411-G		DW2501-G		Units
	Typ	Max	Typ	Max	Typ	Max	Typ	Max	Typ	Max	Typ	Max	Typ	Max	
Passband	34.4 to 39.4		33.65 to 38.9		34.4 to 39.4		33.15 to 38.9		33.65 to 39.15		33.15 to 39.65				MHz
Insertion Loss	29	32	29	32	30	32	29	32	29	32	24	33	28		dB
Passband Ripple	±0.3	±0.5	±0.4	±0.5	±0.15	±0.2		±0.2		±0.5		±0.4		±0.5	dB
Group Delay Ripple	45	60	50	60	40	50		40		40		48		50	ns p-p
Sound	None		1 Channel		None		Stereo		Stereo						-

SYSTEM I FILTERS	DW1502-I		DW1503-I		DW1505-I		DW9231-I		DW9232-I		Units
	Typ	Max	Typ	Max	Typ	Max	Typ	Max	Typ	Max	
Passband	34.25 to 41.25		33.4 to 40.9				33.55 to 38.9		32.1 to 33.0		MHz
Insertion Loss	29	30	29	30	29	30		30		30	dB
Passband Ripple	±0.15	±0.25	±0.15	±0.2		±0.5		±0.3		±0.3	dB
Group Delay Ripple	30	40	30	40		60		40		40	ns p-p
Sound	1 Channel		None		1 Channel		1 Channel		None		-

SYSTEM M FILTERS	DW1603-M		DW1605-M		Units
	Typ	Max	Typ	Max	
Passband	42.17 to 46.25		40.75 to 46.5		MHz
Insertion Loss	30	32	26	29	dB
Passband Ripple		±0.5		±0.5	dB
Group Delay Ripple		50		40	ns p-p
Sound	None		1 Channel		-

SYSTEM K FILTERS	DW1701-K		DW1702-K		Units
	Typ	Max	Typ	Max	
Passband	30.5 to 38.25		29.0 to 38.5		MHz
Insertion Loss	25	26	32	26	dB
Passband Ripple	±0.5		±0.5		dB
Group Delay Ripple		40		40	ns p-p
Sound	None		1 Channel		-

ABSOLUTE MAXIMUM RATINGS

Storage and Operating Temperature = -10°C to +70°C
 Maximum Voltage = See Operating Note 1
 Input Power = +20dBm

OPERATING NOTES

1. Coupling Capacitors

Although there is no DC path within the SAW filter it is advisable to keep any applied DC voltage to <100mV.

Prolonged exposure to voltages in excess of this may adversely affect the life of the filter. Short-term exposure to voltages up to 30 volts should not cause any problems.

2. Temperature Effects

The characteristics of SAW filters of this type behave in a simple predictable manner with temperature. The temperature coefficient of frequency is -90ppm/°C. For example the rejection at 45°C and 40.15MHz will be the same as that at 25°C and 40.22MHz.

3. Mounting Precautions

In order to achieve the quoted rejections it is important to prevent excessive direct breakthrough signals. Normal high frequency precautions such as the use of continuous ground plane and short component leads are necessary. It is most important that the SAW filter is well grounded. All the earth leads on the package should be connected to the ground plane by short connections - plated through holes are ideal.

Direct breakthrough signals produce two main effects:

- Specified out of band rejections not achieved
- Passband ripple is excessive

A simple method to check that the grounding is adequate is to connect the package directly to the ground plane temporarily, and check that the frequency response does not change.

PLOTS

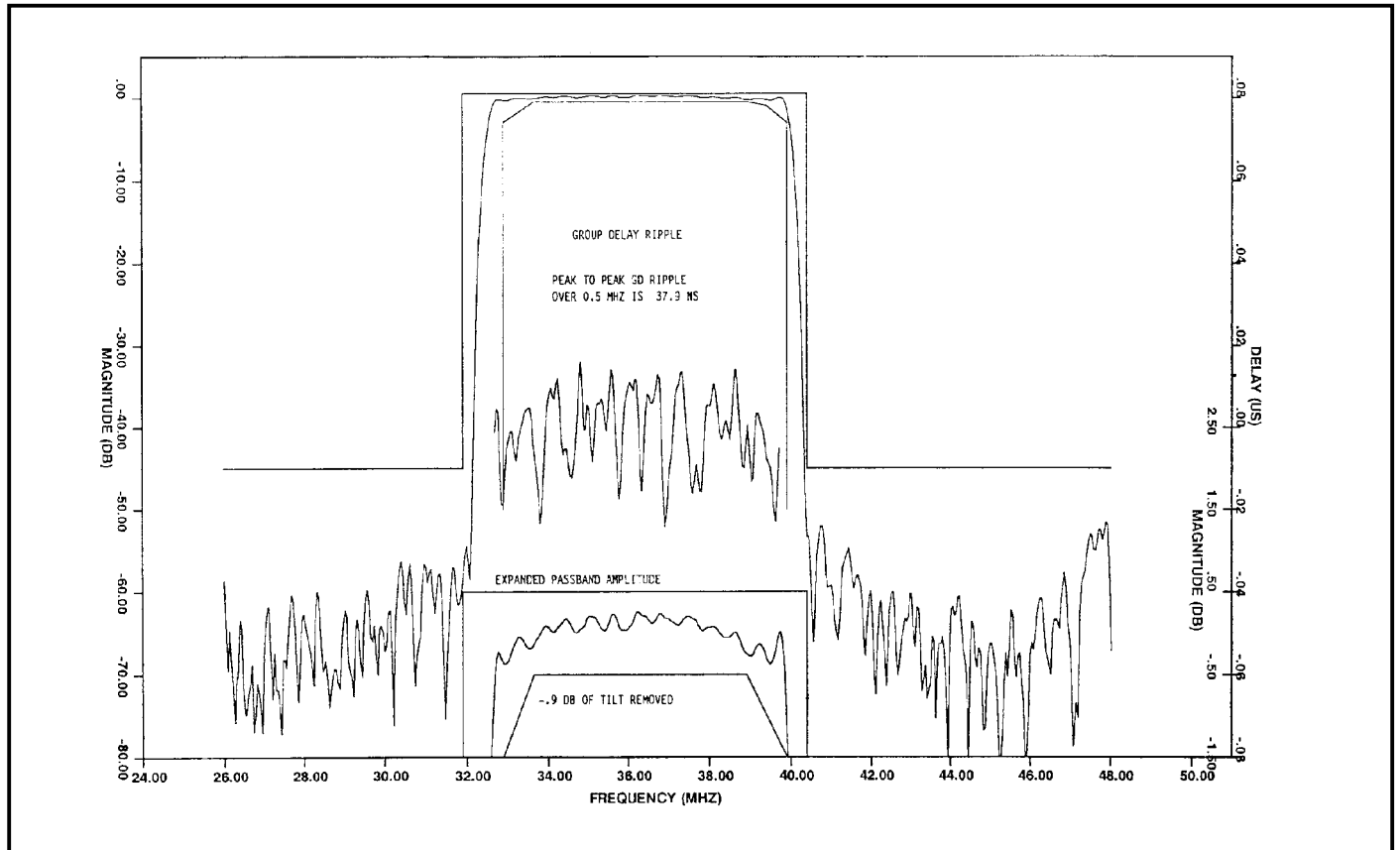

Fig.1 - DW1404-G

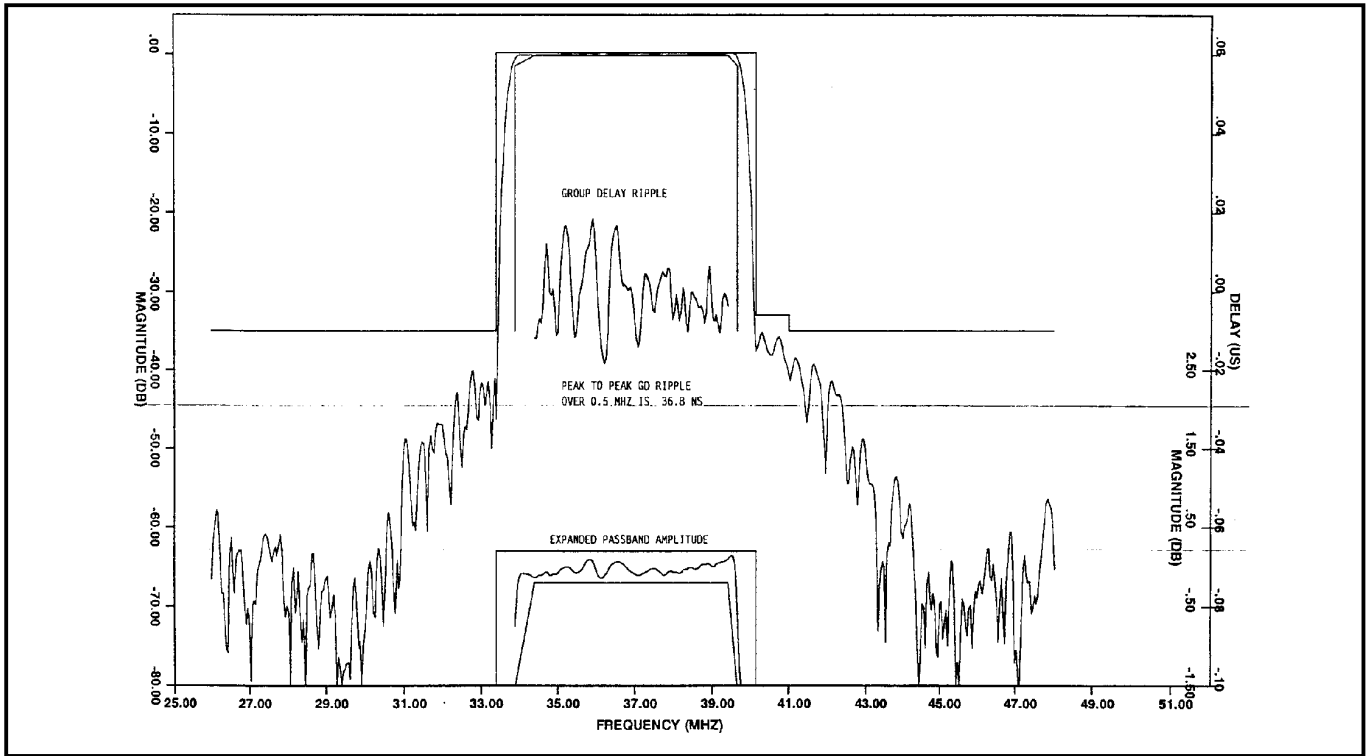

Fig.2 - DW1406-G

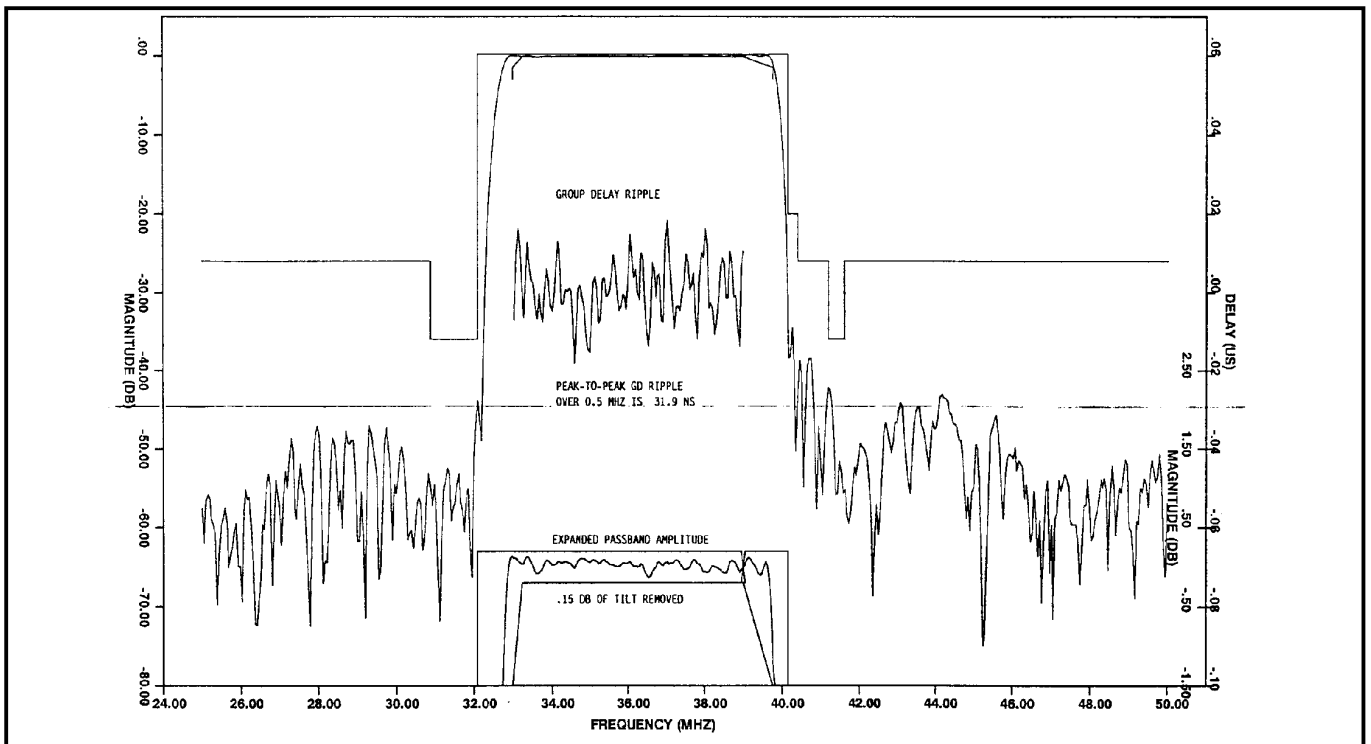

Fig.3 - DW1408-G

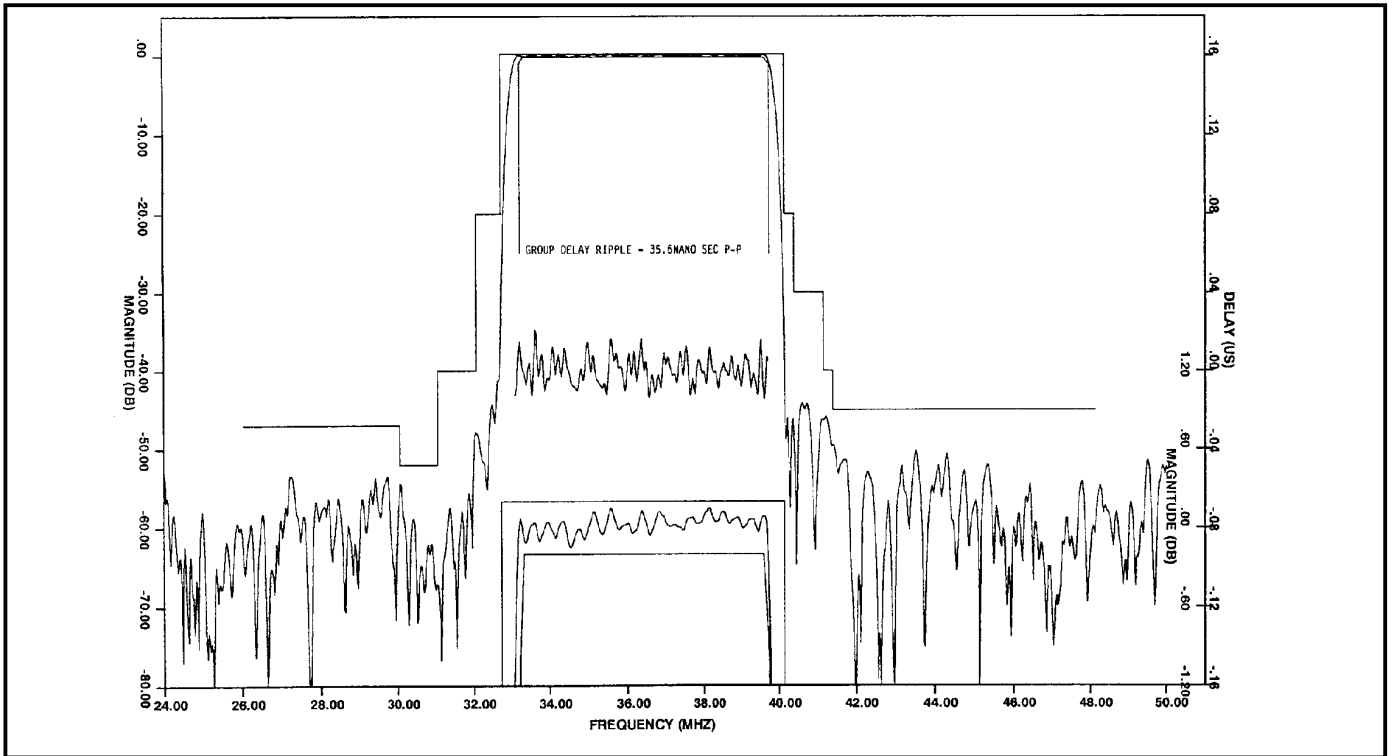

Fig.4 - DW1411-G

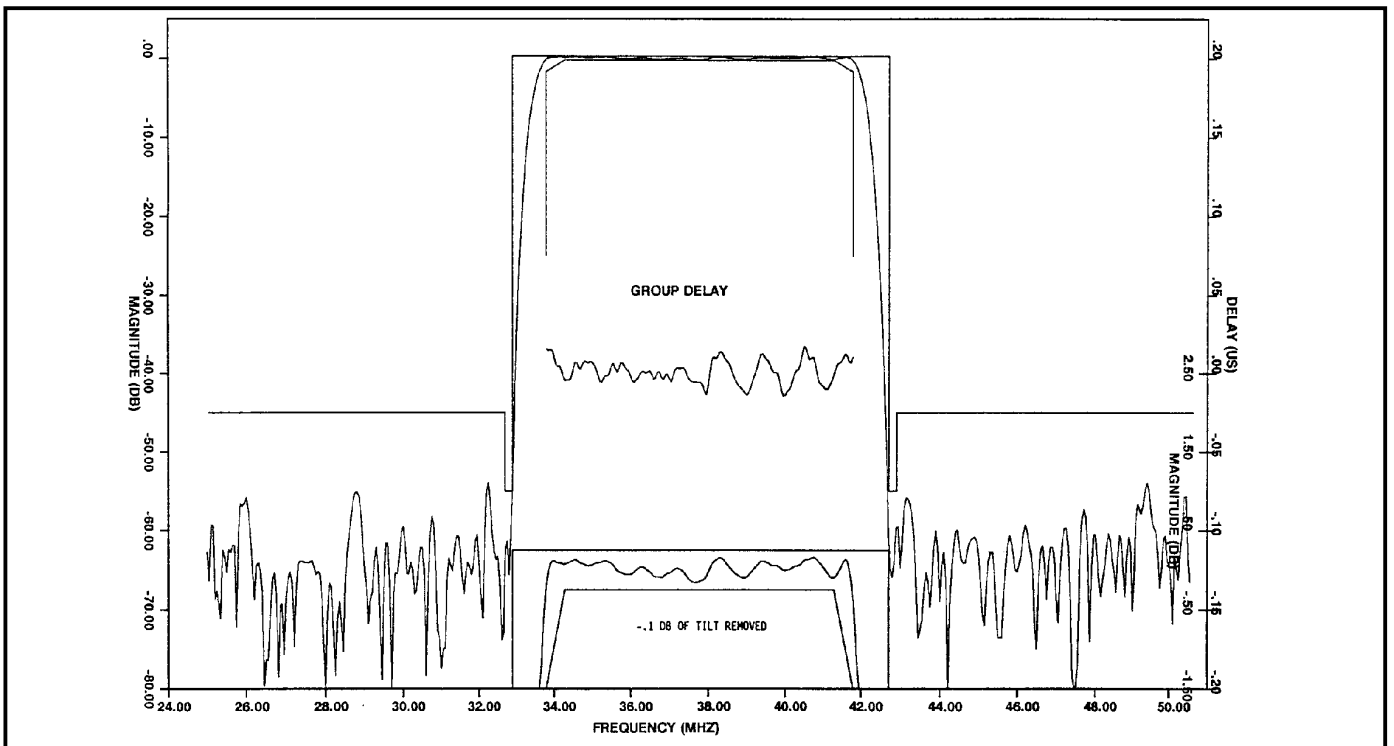

Fig.5 - DW1502-I

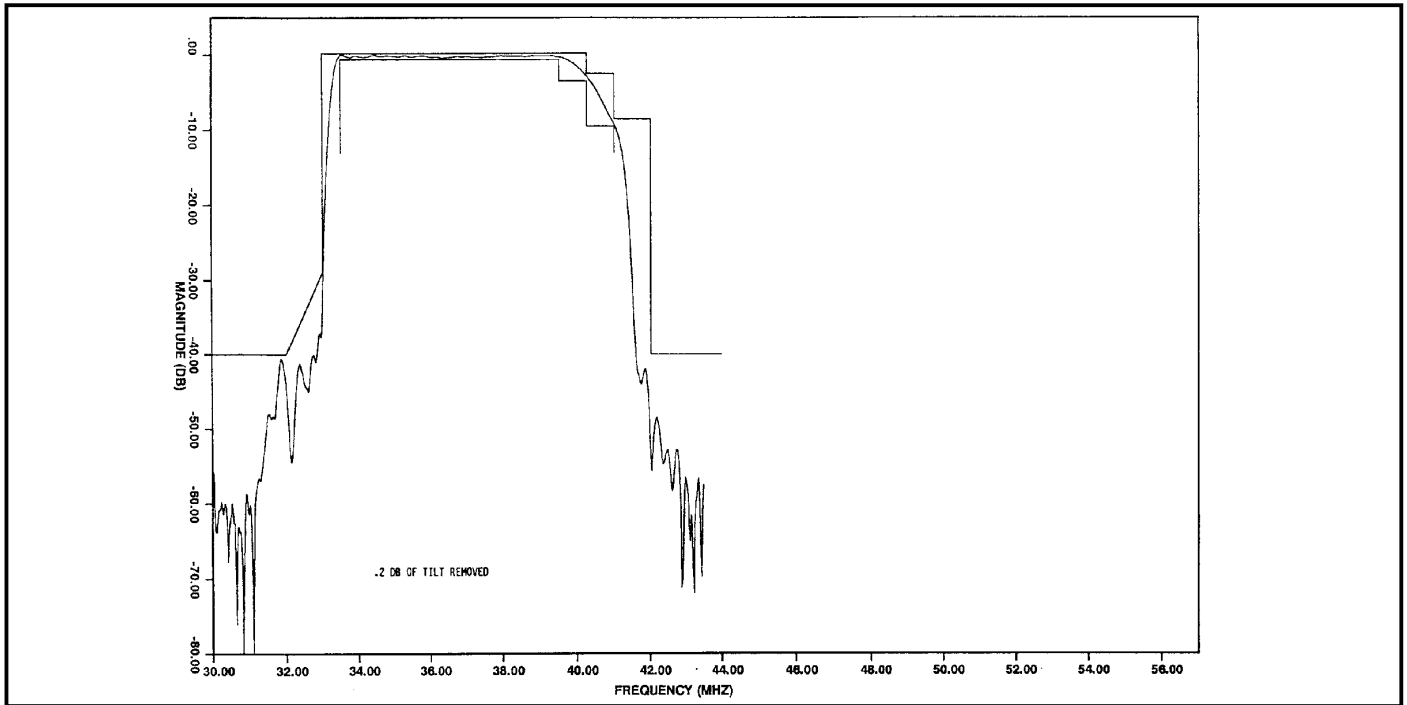
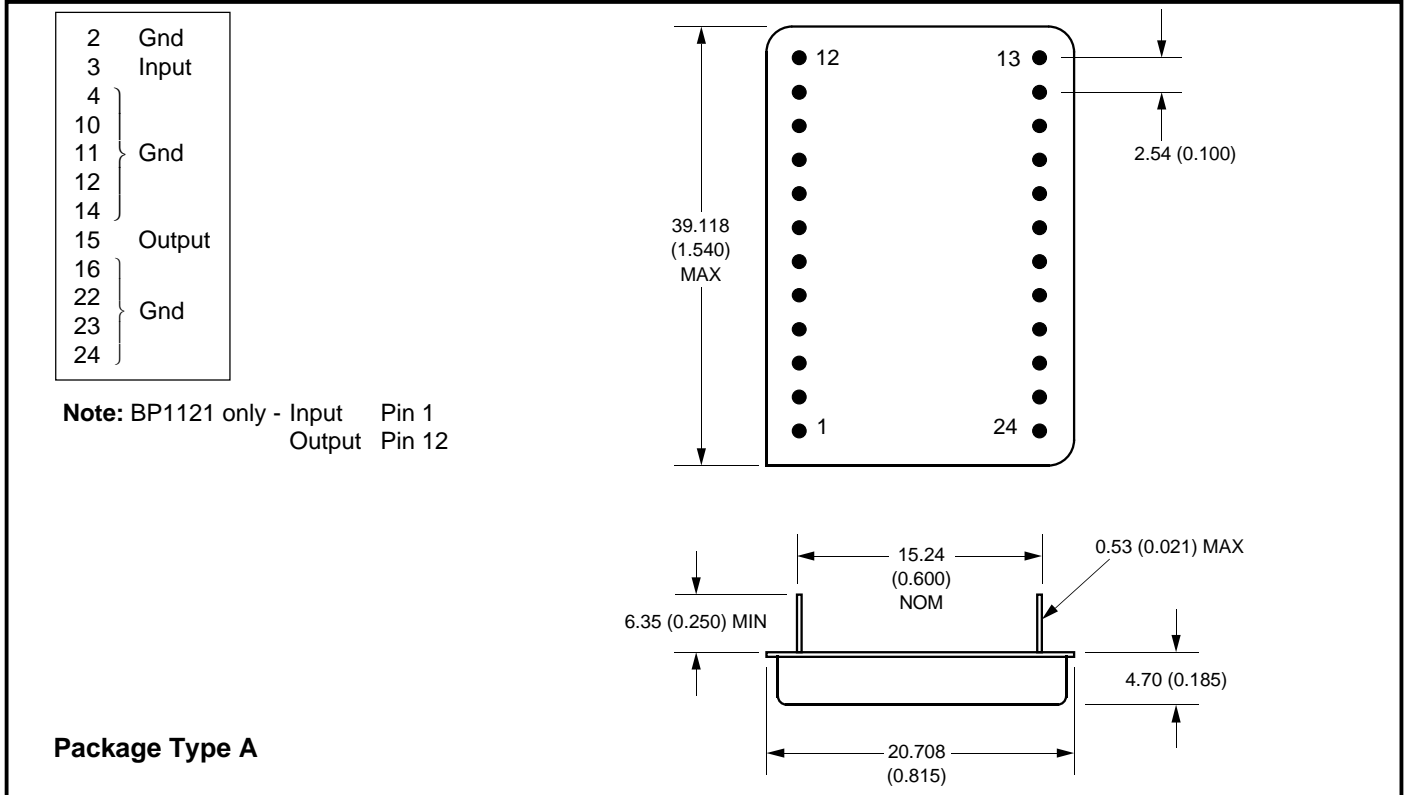
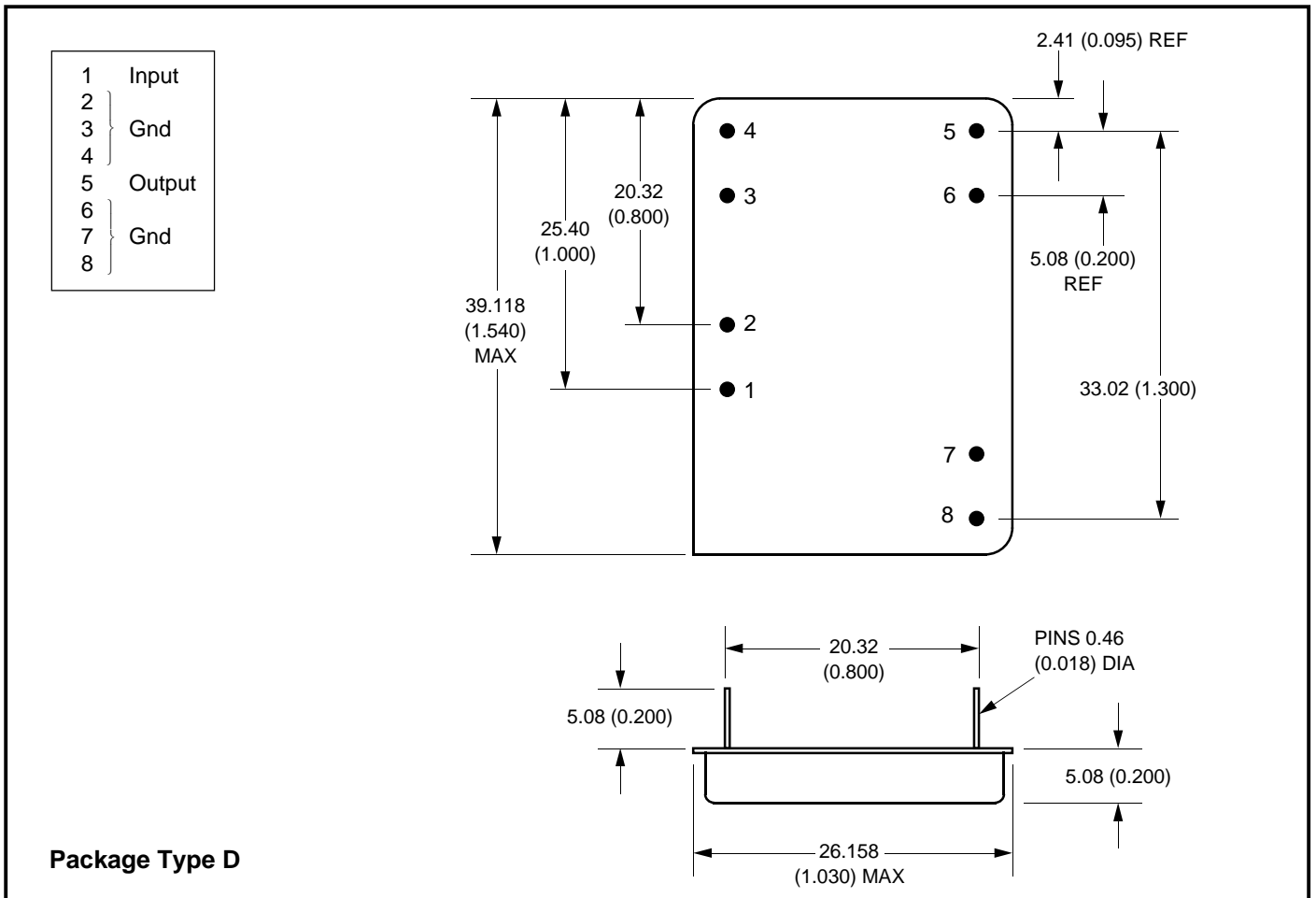

Fig. 6 - DW1503-I

PACKAGE DETAILS







<http://www.dynexsemi.com>

e-mail: space_comms@dynexsemi.com

HEADQUARTERS OPERATIONS
DYNEX SEMICONDUCTOR LTD
Doddington Road, Lincoln.
Lincolnshire. LN6 3LF. United Kingdom.
Tel: +44-(0)1522-500500
Fax: +44-(0)1522-500550

CUSTOMER SERVICE
Tel: +44 (0)1522 502753 / 502901. Fax: +44 (0)1522 500020

SALES OFFICE
Tel: +44 (0)1522 502724. Fax: +44 (0)1522 502777

These offices are supported by Representatives and Distributors in many countries world-wide.
© Dynex Semiconductor 2002 TECHNICAL DOCUMENTATION – NOT FOR RESALE. PRODUCED IN
UNITED KINGDOM

Datasheet Annotations:

Dynex Semiconductor annotate datasheets in the top right hand corner of the front page, to indicate product status. The annotations are as follows:-

Target Information: This is the most tentative form of information and represents a very preliminary specification. No actual design work on the product has been started.

Preliminary Information: The product is in design and development. The datasheet represents the product as it is understood but details may change.

Advance Information: The product design is complete and final characterisation for volume production is well in hand.

No Annotation: The product parameters are fixed and the product is available to datasheet specification.

This publication is issued to provide information only which (unless agreed by the Company in writing) may not be used, applied or reproduced for any purpose nor form part of any order or contract nor to be regarded as a representation relating to the products or services concerned. No warranty or guarantee express or implied is made regarding the capability, performance or suitability of any product or service. The Company reserves the right to alter without prior notice the specification, design or price of any product or service. Information concerning possible methods of use is provided as a guide only and does not constitute any guarantee that such methods of use will be satisfactory in a specific piece of equipment. It is the user's responsibility to fully determine the performance and suitability of any equipment using such information and to ensure that any publication or data used is up to date and has not been superseded. These products are not suitable for use in any medical products whose failure to perform may result in significant injury or death to the user. All products and materials are sold and services provided subject to the Company's conditions of sale, which are available on request.

All brand names and product names used in this publication are trademarks, registered trademarks or trade names of their respective owners.
