



SPC5604

N & P Pair Enhancement Mode MOSFET

DESCRIPTION

The SPC5604 is the N- and P-Channel enhancement mode power field effect transistors are produced using high cell density, DMOS trench technology. This high density process is especially tailored to minimize on-state resistance and provide superior switching performance. These devices are particularly suited for low voltage applications such as notebook computer power management and other battery powered circuits where high-side switching, low in-line power loss, and resistance to transients are needed.

FEATURES

- ◆ N-Channel
 - 40V/10A, $R_{DS(ON)} = 24m\Omega @ V_{GS} = 10V$
 - 40V/ 8A, $R_{DS(ON)} = 28m\Omega @ V_{GS} = 4.5V$
 - 40V/ 6A, $R_{DS(ON)} = 32m\Omega @ V_{GS} = 2.5V$
- ◆ P-Channel
 - 40V/-10A, $R_{DS(ON)} = 32m\Omega @ V_{GS} = -10V$
 - 40V/- 8A, $R_{DS(ON)} = 42m\Omega @ V_{GS} = -4.5V$
- ◆ Super high density cell design for extremely low $R_{DS(ON)}$
- ◆ Exceptional on-resistance and maximum DC current capability
- ◆ TO-252-5L package design

APPLICATIONS

- Power Management in Note book
- Battery Powered System
- DC/DC Converter
- LCD Display inverter

PIN CONFIGURATION

(TO-252-5L) (TO-252-4L)

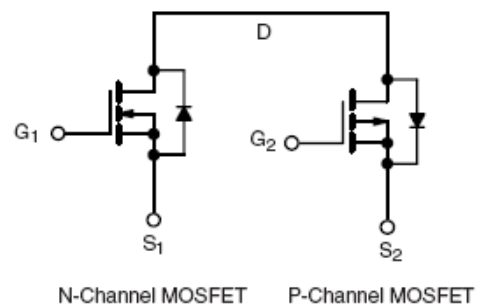
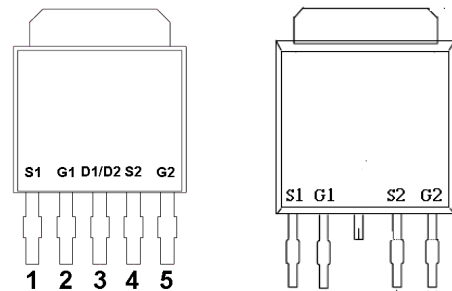

PART MARKING

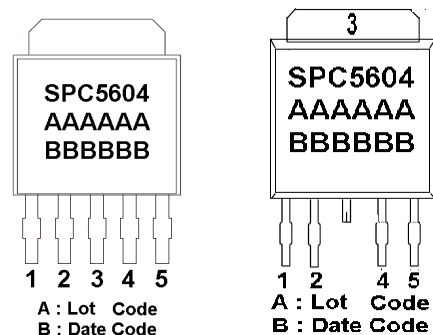



SPC5604

N & P Pair Enhancement Mode MOSFET

PIN DESCRIPTION

Pin	Description(TO-252-5L)	Description(TO-252-4L)
1	Source 1	Source 1
2	Gate 1	Gate 1
3	Drain1/Drain2	Drain
4	Source 2	Source 2
5	Gate 2	Gate 2

ORDERING INFORMATION

Part Number	Package	Part Marking
SPC5604T255RGB	T0-252-5L	SPC5604
SPC5604T254RGB	T0-252-4L	SPC5604

※ SPC5604T255RGB: 13" Tape Reel ; Pb – Free ; Halogen – Free

※ SPC5604T254RGB :13" Tape Reel ; Pb – Free ; Halogen – Free

ABSOLUTE MAXIMUM RATINGS

(TA=25°C Unless otherwise noted)

Parameter	Symbol	Typical		Unit	
		N-Channel	P-Channel		
Drain-Source Voltage	V _{DSS}	40	-40	V	
Gate –Source Voltage	V _{GSS}	±20	±20	V	
Continuous Drain Current(T _J =150°C)	I _D	TA=25°C	10.0	-10.0	A
		TA=70°C	7.0	-7.0	
Pulsed Drain Current	I _{DM}	25	-25	A	
Continuous Source Current(Diode Conduction)	I _S	2.3	-2.3	A	
Power Dissipation	P _D	TA=25°C	2.5	2.8	W
		TA=70°C	1.6	1.8	
Operating Junction Temperature	T _J	-55/150		°C	
Storage Temperature Range	T _{STG}	-55/150		°C	
Thermal Resistance-Junction to Ambient	R _{θJA}	T ≤ 10sec	50	52	°C/W
		Steady State	80	80	



SPC5604

N & P Pair Enhancement Mode MOSFET

ELECTRICAL CHARACTERISTICS (NMOS)

(TA=25°C Unless otherwise noted)

Parameter	Symbol	Conditions	Min.	Typ	Max.	Unit
Static						
Drain-Source Breakdown Voltage	$V_{(BR)DSS}$	$V_{GS}=0V, I_D=250\mu A$	40			V
Gate Threshold Voltage	$V_{GS(th)}$	$V_{DS}=V_{GS}, I_D=250\mu A$	0.5		1.0	
Gate Leakage Current	I_{GSS}	$V_{DS}=0V, V_{GS}=\pm 20V$			± 100	nA
Zero Gate Voltage Drain Current	I_{DSS}	$V_{DS}=32V, V_{GS}=0V$			1	uA
		$V_{DS}=32V, V_{GS}=0V$ $T_J=85^\circ C$			10	
On-State Drain Current	$I_{D(on)}$	$V_{DS}= 5V, V_{GS} =4.5V$	10			A
Drain-Source On-Resistance	$R_{DS(on)}$	$V_{GS}= 10V, I_D=10A$		0.018	0.024	Ω
		$V_{GS}=4.5V, I_D= 8A$		0.022	0.028	
		$V_{GS}=2.5V, I_D= 6A$		0.026	0.032	
Forward Transconductance	g_{fs}	$V_{DS}=15V, I_D=6.2A$		13		S
Diode Forward Voltage	V_{SD}	$I_S=2.3A, V_{GS} =0V$		0.8	1.2	V
Dynamic						
Total Gate Charge	Q_g	$V_{DS}=20V, V_{GS}=4.5V$ $I_D= 5A$		10	14	nC
Gate-Source Charge	Q_{gs}			2.8		
Gate-Drain Charge	Q_{gd}			3.2		
Input Capacitance	C_{iss}	$V_{DS}=20V, V_{GS}=0V$ $f=1MHz$		850		pF
Output Capacitance	C_{oss}			110		
Reverse Transfer Capacitance	C_{rss}			75		
Turn-On Time	$t_{d(on)}$	$V_{DD}=20V, R_L=4\Omega$ $I_D=5.0A, V_{GEN}=10V$ $R_G=1\Omega$		6	12	nS
	t_r			10	20	
Turn-Off Time	$t_{d(off)}$			20	36	
	t_f			6	12	



SPC5604

N & P Pair Enhancement Mode MOSFET

ELECTRICAL CHARACTERISTICS (PMOS)

(TA=25°C Unless otherwise noted)

Parameter	Symbol	Conditions	Min.	Typ	Max.	Unit
Static						
Drain-Source Breakdown Voltage	$V_{(BR)DSS}$	$V_{GS}=0V, I_D=-250\mu A$	-40			V
Gate Threshold Voltage	$V_{GS(th)}$	$V_{DS}=V_{GS}, I_D=-250\mu A$	-0.8		-2.5	
Gate Leakage Current	I_{GSS}	$V_{DS}=0V, V_{GS}=\pm 20V$			± 100	nA
Zero Gate Voltage Drain Current	I_{DSS}	$V_{DS}=-32V, V_{GS}=0V$			-1	uA
		$V_{DS}=-32V, V_{GS}=0V$ $T_J=85^\circ C$			-10	
On-State Drain Current	$I_{D(on)}$	$V_{DS}=-5V, V_{GS}=-4.5V$	-10			A
Drain-Source On-Resistance	$R_{DS(on)}$	$V_{GS}=-10V, I_D=-10A$		0.028	0.032	Ω
		$V_{GS}=-4.5V, I_D=-8A$		0.038	0.042	
Forward Transconductance	g_{fs}	$V_{DS}=-15V, I_D=-5.7A$		13		S
Diode Forward Voltage	V_{SD}	$I_S=-2.3A, V_{GS}=0V$		-0.8	-1.2	V
Dynamic						
Total Gate Charge	Q_g	$V_{DS}=-20V, V_{GS}=-4.5V$ $I_D=-5.0A$		13	20	nC
Gate-Source Charge	Q_{gs}			4.5		
Gate-Drain Charge	Q_{gd}			6.5		
Input Capacitance	C_{iss}	$V_{DS}=-20V, V_{GS}=0V$ $f=1MHz$		1100		pF
Output Capacitance	C_{oss}			145		
Reverse Transfer Capacitance	C_{rss}			115		
Turn-On Time	$t_{d(on)}$	$V_{DD}=-20V, R_L=4\Omega$ $I_D=-5.0A, V_{GEN}=-4.5V$ $R_G=1\Omega$		40	80	nS
	t_r			55	100	
Turn-Off Time	$t_{d(off)}$			30	60	
	t_f			12	20	



SPC5604 N & P Pair Enhancement Mode MOSFET

TYPICAL CHARACTERISTICS (NMOS)

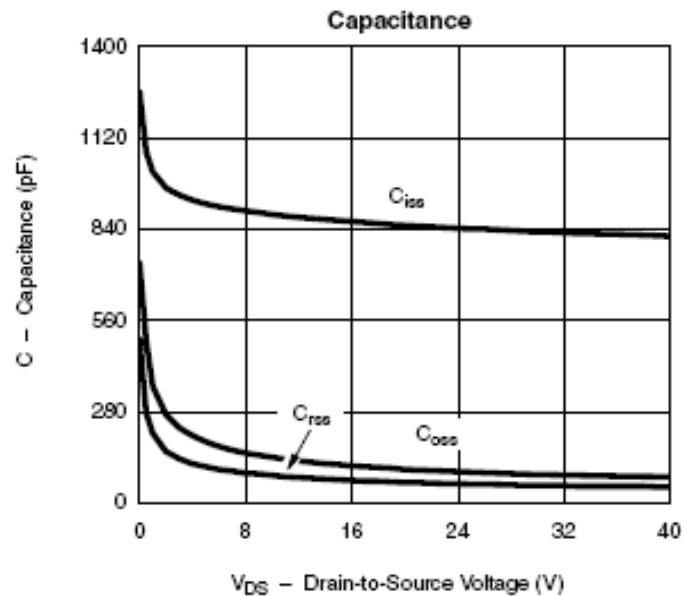
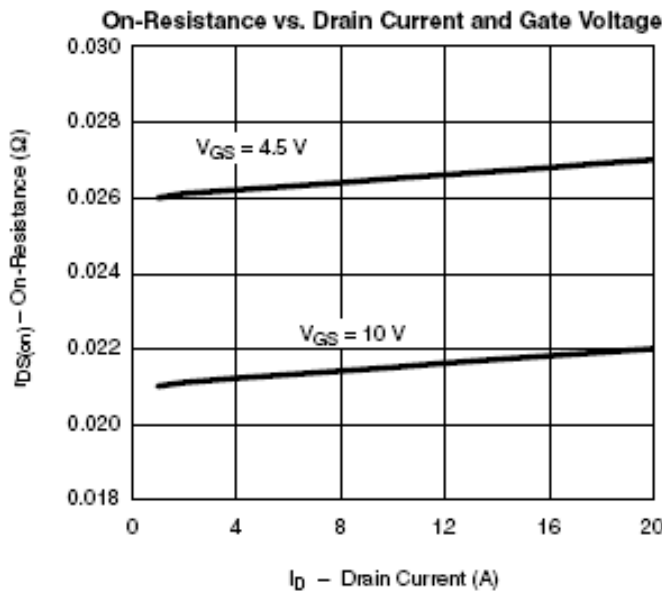
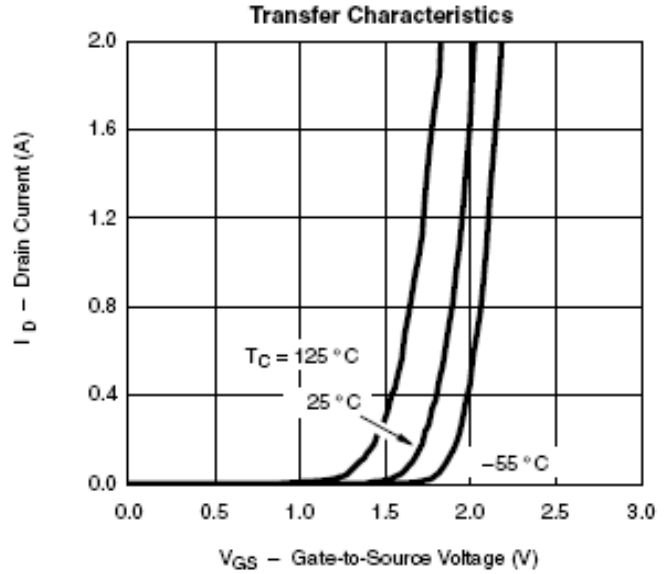
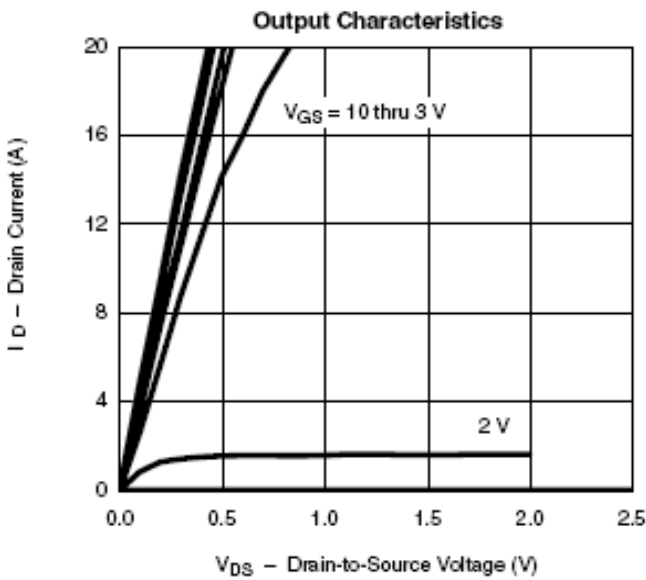



SPC5604 N & P Pair Enhancement Mode MOSFET

TYPICAL CHARACTERISTICS (NMOS)

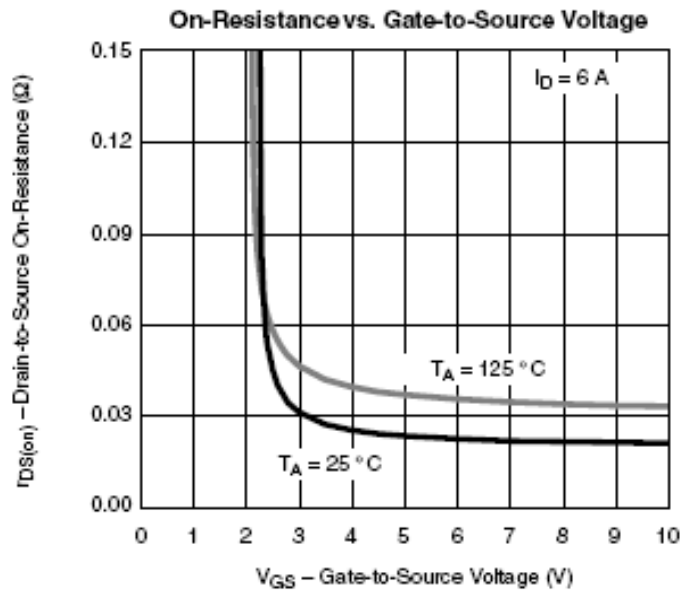
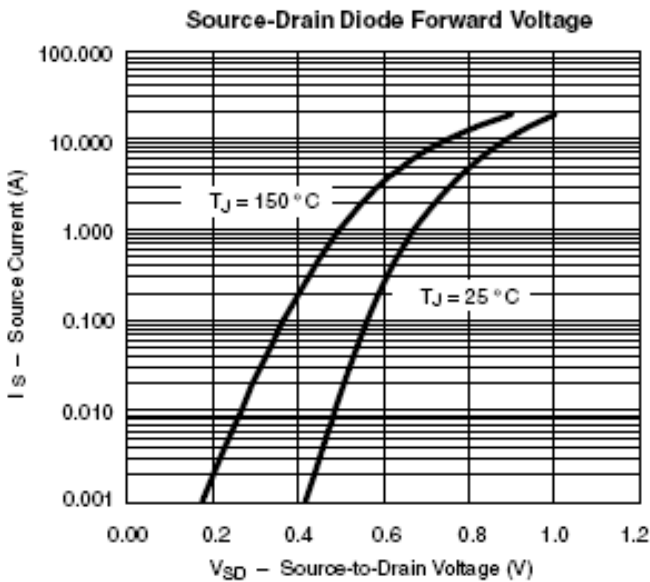
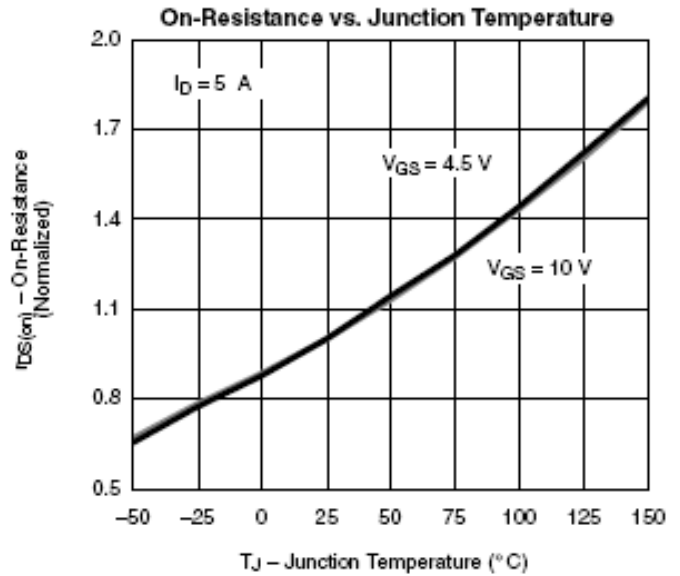
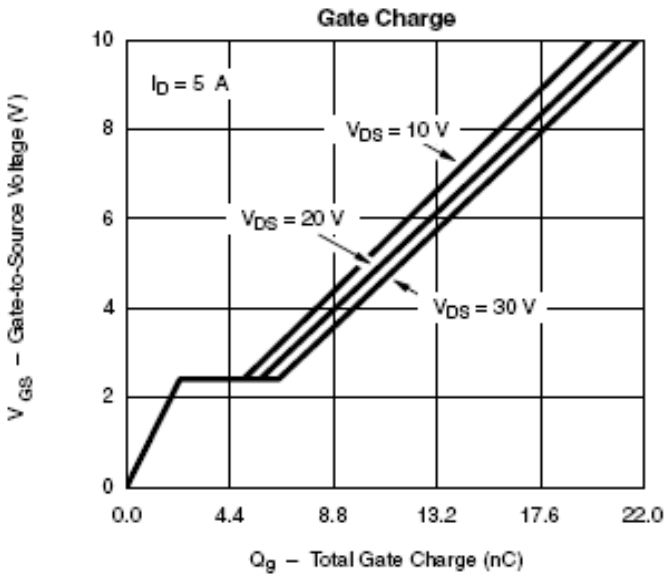



SPC5604 N & P Pair Enhancement Mode MOSFET

TYPICAL CHARACTERISTICS (NMOS)

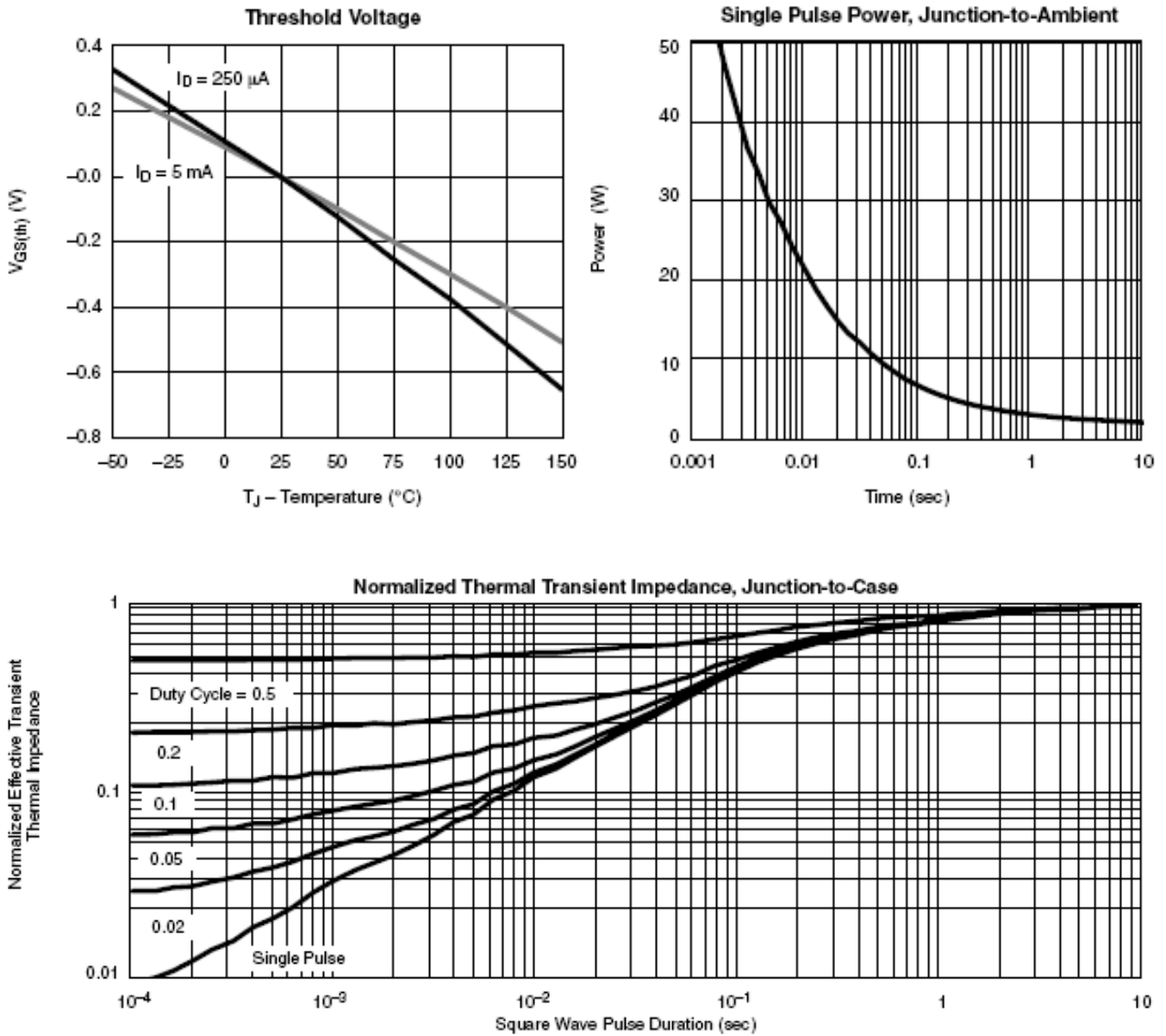



SPC5604 N & P Pair Enhancement Mode MOSFET

TYPICAL CHARACTERISTICS (PMOS)

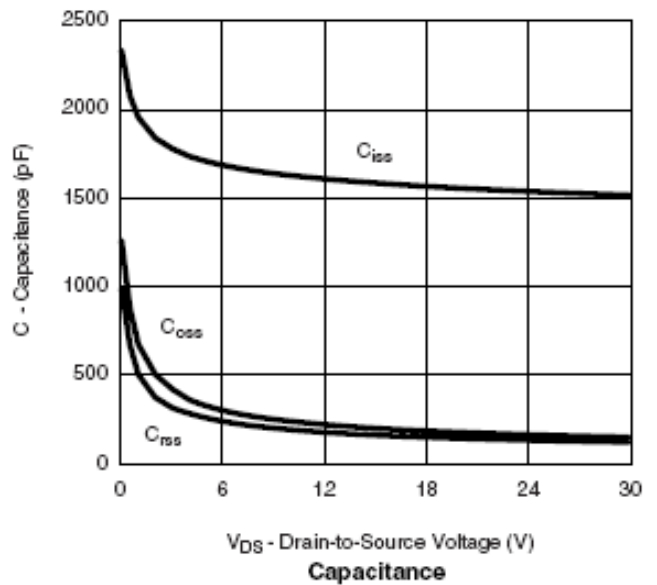
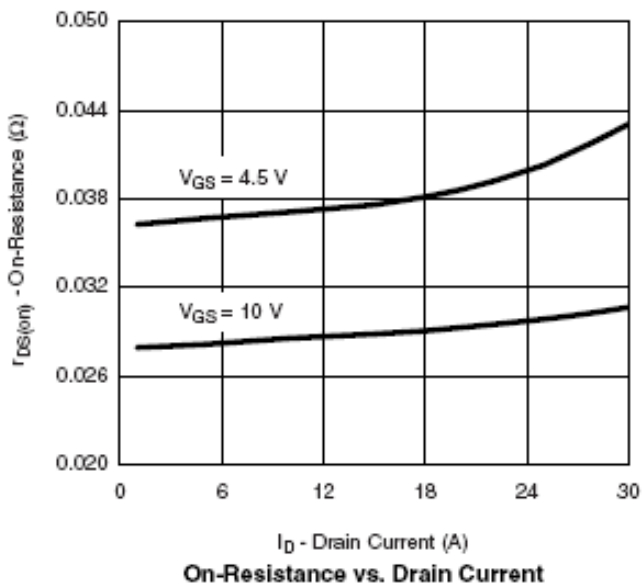
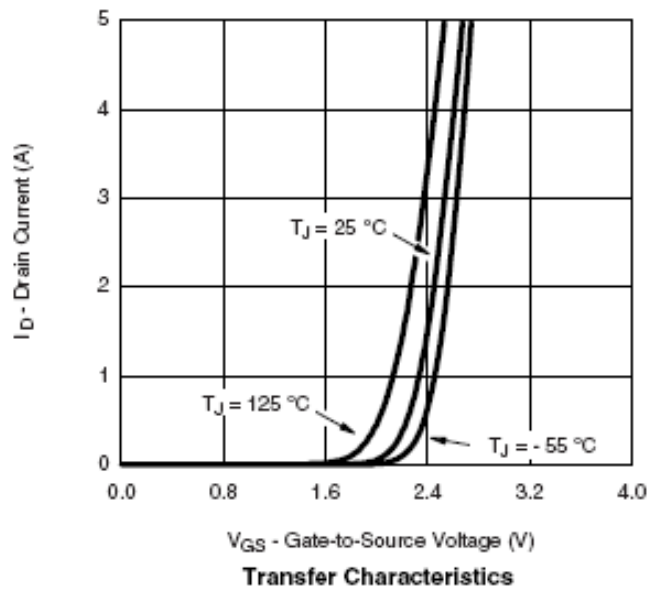
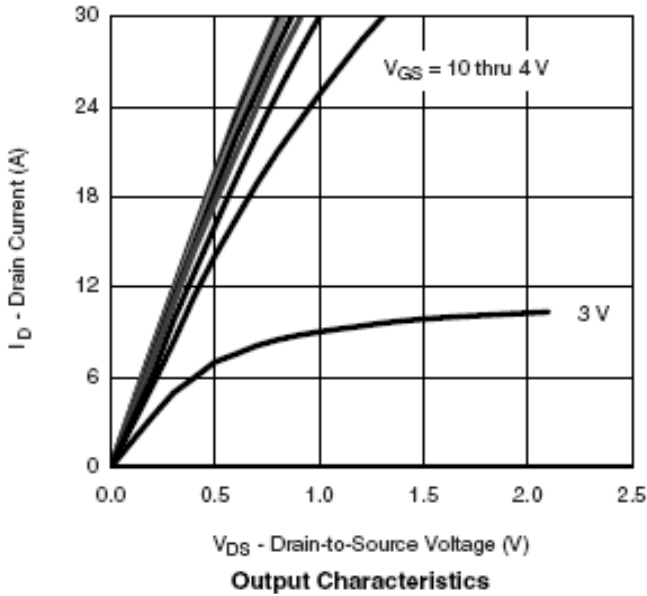



SPC5604 N & P Pair Enhancement Mode MOSFET

TYPICAL CHARACTERISTICS (PMOS)

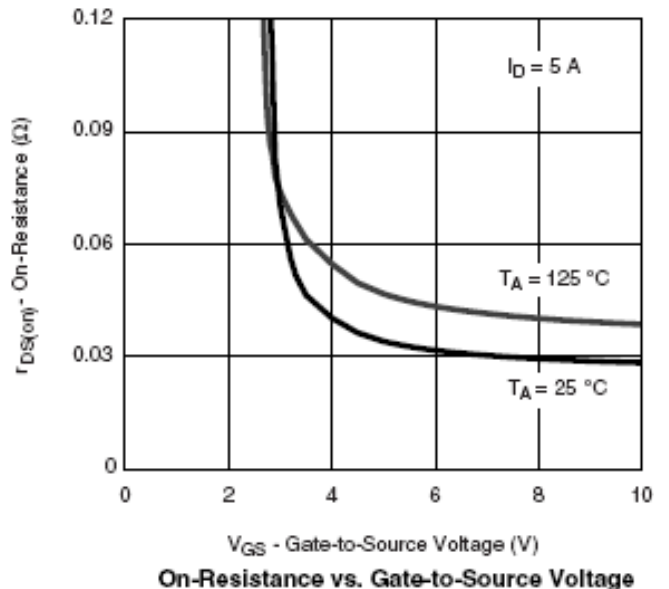
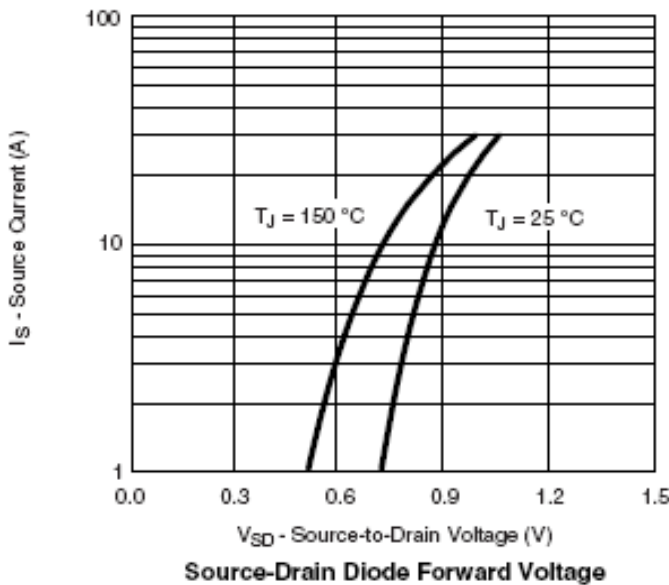
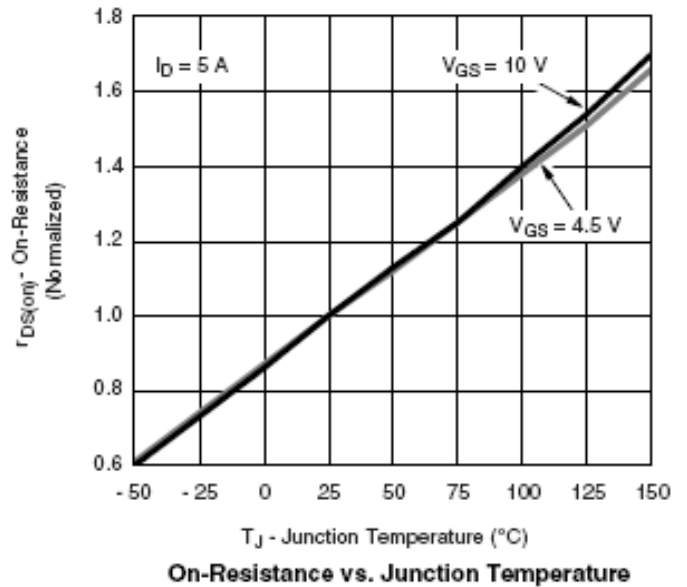
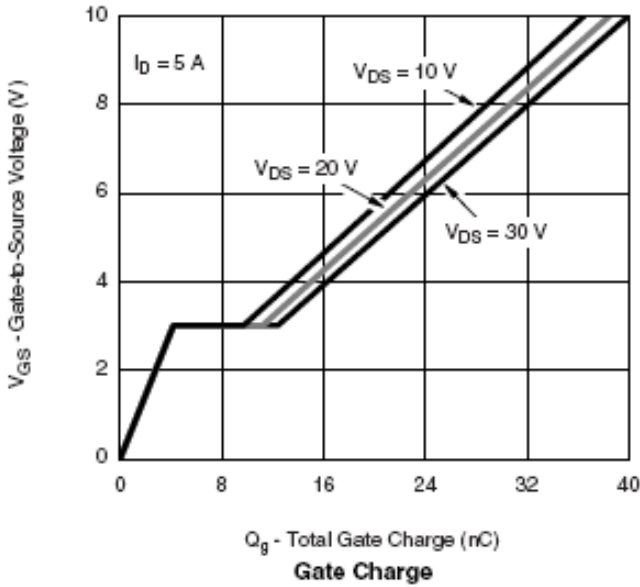



SPC5604 N & P Pair Enhancement Mode MOSFET

TYPICAL CHARACTERISTICS (PMOS)

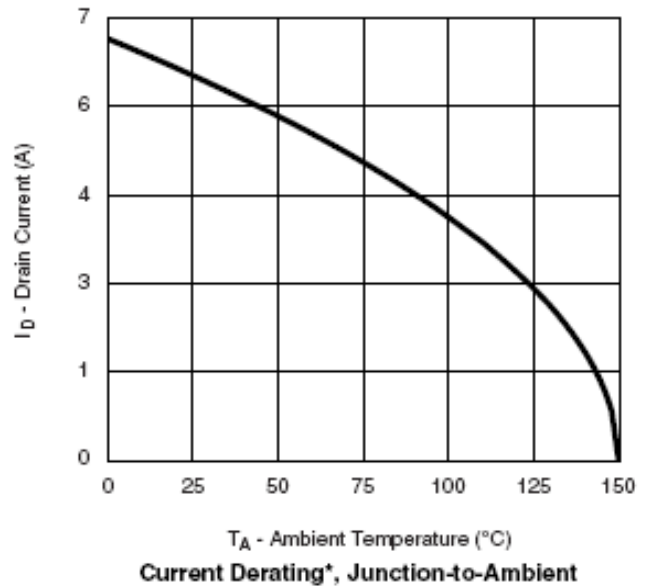
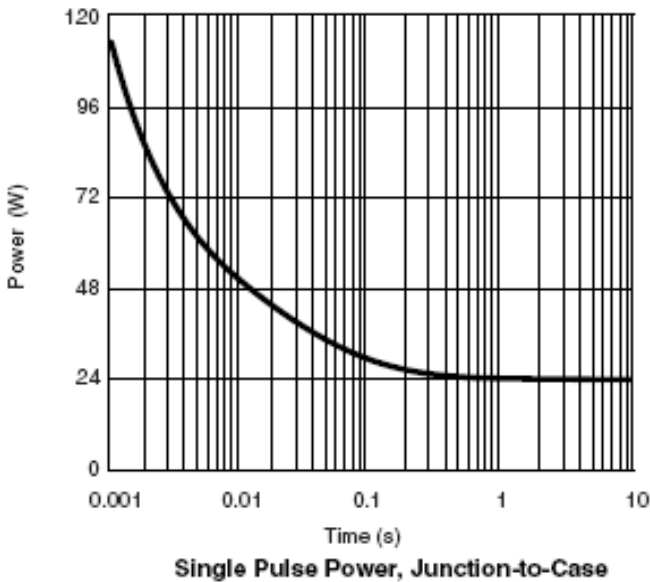
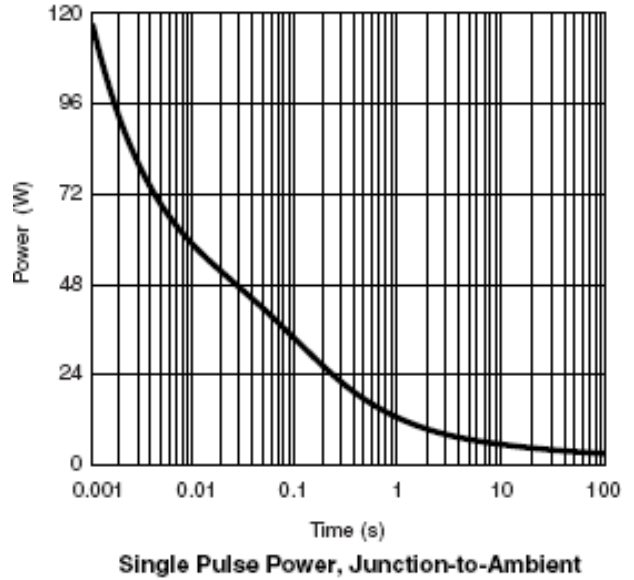
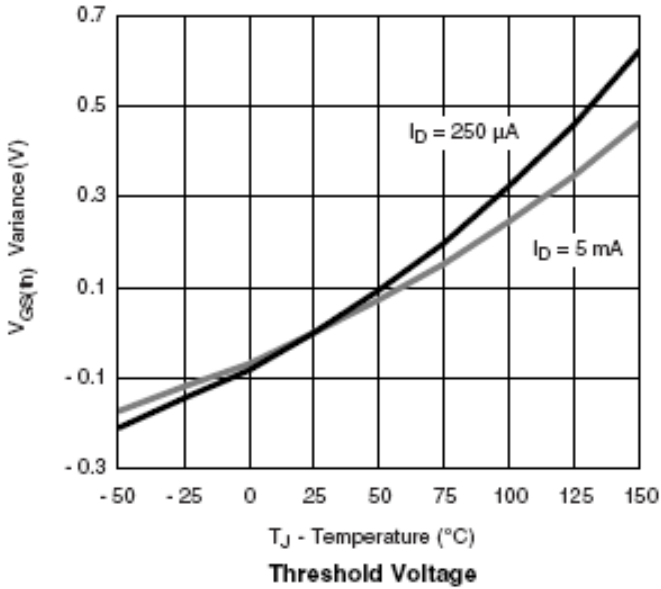



SPC5604 N & P Pair Enhancement Mode MOSFET

TYPICAL CHARACTERISTICS (PMOS)

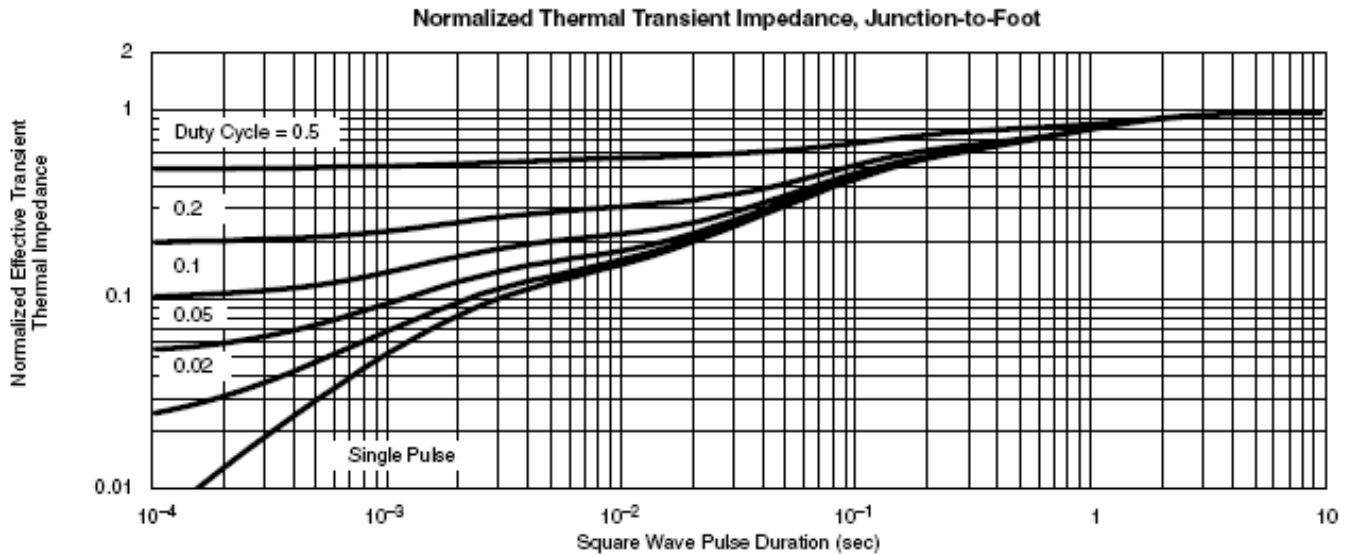
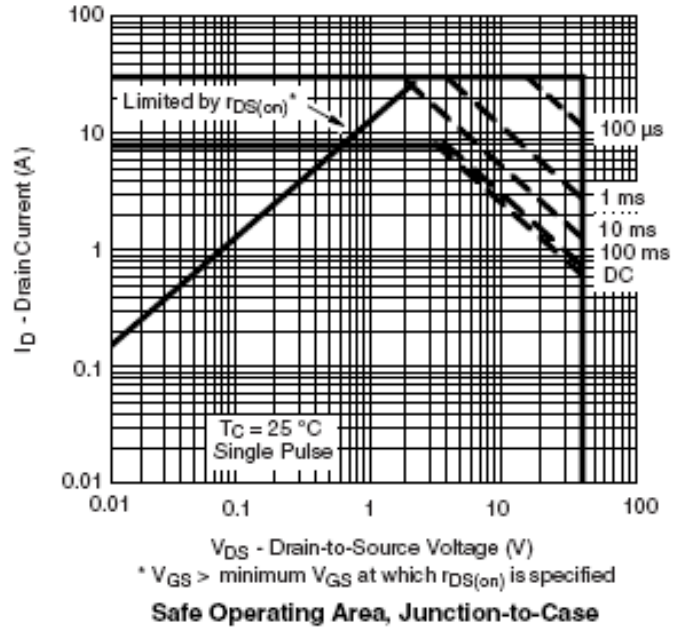
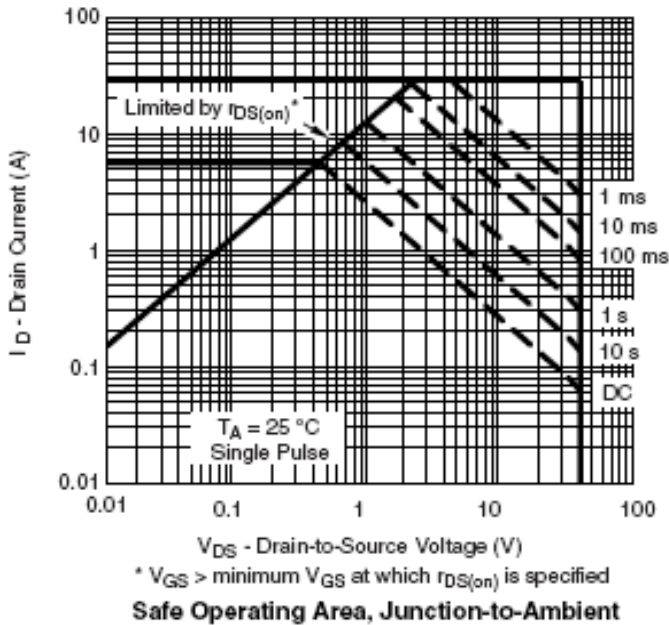



SPC5604

N & P Pair Enhancement Mode MOSFET

TO-252-5L PACKAGE OUTLINE

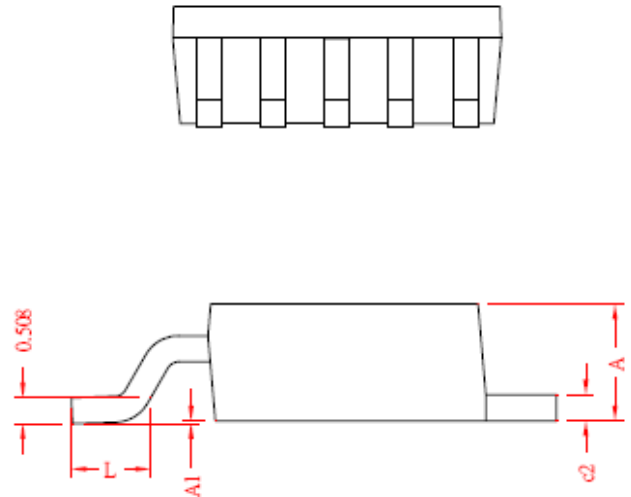
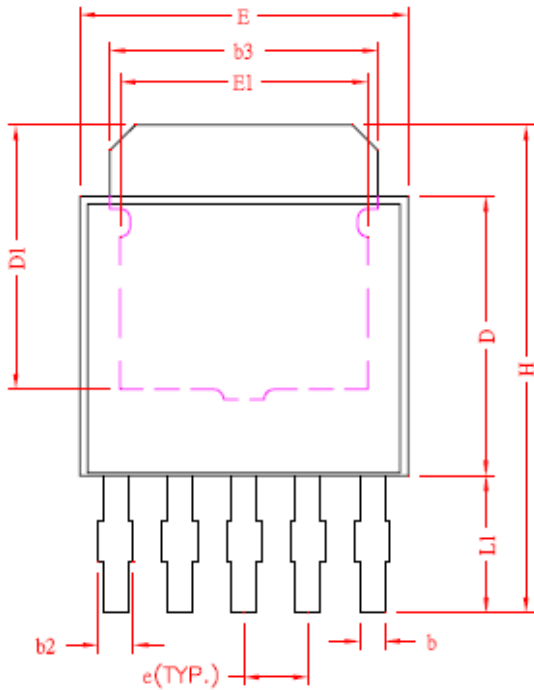

DIMENSIONS					
REF.	Millimeter		REF.	Millimeter	
	Min.	Max.		Min.	Max.
A	2.20	2.40	D1	4.57	---
A1	0	0.15	E	6.35	6.73
b	0.45	0.60	E1	3.81	---
b2	0.50	0.80	e	1.27 REF.	
b3	5.21	5.46	H	9.40	10.20
c2	0.46	0.58	L	1.40	1.77
D	5.40	5.59	L1	2.40	3.00



SPC5604 N & P Pair Enhancement Mode MOSFET

TO-252-4L PACKAGE OUTLINE

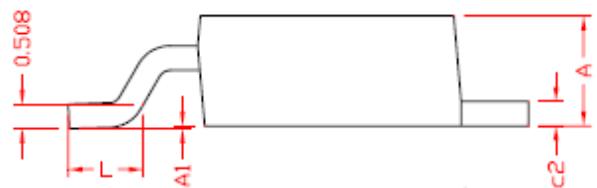
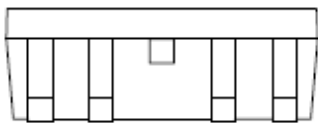
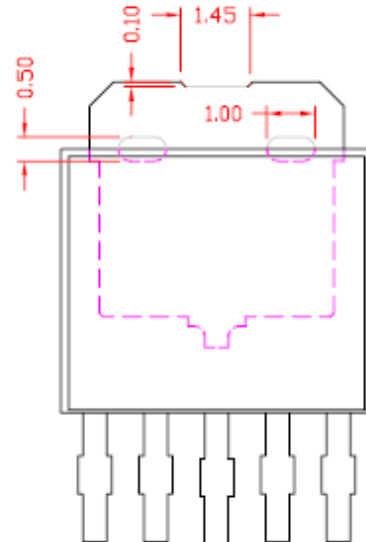
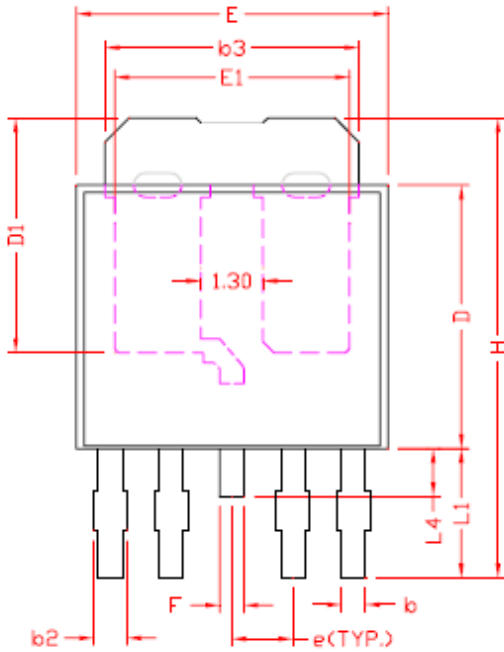

REF.	Millimeter		REF.	Millimeter	
	Min.	Max.		Min.	Max.
A	2.20	2.40	E	6.40	6.80
A1	0	0.15	E1	3.81	---
b	0.40	0.60	e	1.27 REF.	
b2	0.50	0.80	F	0.40	0.60
b3	5.20	5.50	H	9.40	10.20
c2	0.45	0.55	L	1.40	1.77
D	5.40	5.80	L1	2.40	3.00
D1	4.27	---	L4	0.80	1.20



SPC5604

N & P Pair Enhancement Mode MOSFET

Information provided is alleged to be exact and consistent. SYNC Power Corporation presumes no responsibility for the penalties of use of such information or for any violation of patents or other rights of third parties which may result from its use. No license is granted by allegation or otherwise under any patent or patent rights of SYNC Power Corporation. Conditions mentioned in this publication are subject to change without notice. This publication surpasses and replaces all information previously supplied. SYNC Power Corporation products are not authorized for use as critical components in life support devices or systems without express written approval of SYNC Power Corporation.

©The SYNC Power logo is a registered trademark of SYNC Power Corporation

©2004 SYNC Power Corporation – Printed in Taiwan – All Rights Reserved

SYNC Power Corporation

7F-2, No.3-1, Park Street

NanKang District (NKSP), Taipei, Taiwan 115

Phone: 886-2-2655-8178

Fax: 886-2-2655-8468

©<http://www.syncpower.com>