



FEATURES

- RoHS compliant
- Up to 2.0A I_{dc}
- 1.0μH to 470μH
- Ultra low profile
- Low R_{DC}
- Tape and reel packaging
- J-STD-020C reflow
- Backward compatible with Sn/Pb soldering systems

DESCRIPTION

The 8200 series is a range of miniature, surface-mount, I-core power inductors. They are designed for use in power applications with restricted PCB space and height, such as ExpressCard™ technology, handheld devices, DC-DC converters and notebook computers. The products are supplied in tape and reel for high-volume, automated surface-mount assembly.

SELECTION GUIDE

| Order Code | Inductance, L | | I _{dc} (Max.) ¹ | Q Factor | | SRF (Typ.) MHz | R _{dc} (Max.) Ω |
|------------|---------------|-----------|--|----------|--------------|-------------------|-----------------------------|
| | 0.1V @ 10KHz | Tolerance | | Q (Min.) | at frequency | | |
| | μH | % | A | | | | |
| 82102C | 1.0 | ±20% | 2.0 | 18 | 1MHz | 133 | 0.058 |
| 82152C | 1.5 | ±20% | 1.4 | 18 | 1MHz | 103 | 0.068 |
| 82222C | 2.2 | ±20% | 1.1 | 18 | 1MHz | 85 | 0.104 |
| 82332C | 3.3 | ±20% | 0.95 | 18 | 1MHz | 67 | 0.138 |
| 82472C | 4.7 | ±20% | 0.80 | 20 | 1MHz | 58 | 0.190 |
| 82682C | 6.8 | ±20% | 0.64 | 20 | 1MHz | 46 | 0.270 |
| 82103C | 10 | ±10% | 0.50 | 35 | 1MHz | 38 | 0.400 |
| 82153C | 15 | ±10% | 0.40 | 35 | 1MHz | 31 | 0.560 |
| 82223C | 22 | ±10% | 0.32 | 35 | 1MHz | 25 | 0.920 |
| 82333C | 33 | ±10% | 0.27 | 40 | 1MHz | 20 | 1.30 |
| 82473C | 47 | ±10% | 0.25 | 40 | 1MHz | 17 | 1.69 |
| 82683C | 68 | ±10% | 0.20 | 40 | 1MHz | 15 | 2.55 |
| 82104C | 100 | ±10% | 0.16 | 40 | 800k | 13 | 3.5 |
| 82154C | 150 | ±10% | 0.13 | 40 | 800k | 11 | 5.9 |
| 82224C | 220 | ±10% | 0.10 | 40 | 800k | 10 | 8.0 |
| 82334C | 330 | ±10% | 0.08 | 40 | 800k | 9 | 13.5 |
| 82474C | 470 | ±10% | 0.07 | 50 | 800k | 9 | 16.8 |

ABSOLUTE MAXIMUM RATINGS

| | |
|--------------------------------------|----------------|
| Operating free air temperature range | -40°C to 85°C |
| Storage temperature range | -40°C to 125°C |

SOLDERING INFORMATION²

| | |
|-------------------------|----------------|
| Peak reflow temperature | 260°C |
| Pin finish | Hot dipped tin |

Specifications typical at T_a = 25°C

- 1 The maximum DC current occurs when either the inductance falls to 75% of its nominal value or when its temperature rise reaches 40°C, whichever is sooner.
- 2 For further information, please visit www.murata-ps.com/rohs



For full details go to
www.murata-ps.com/rohs

INDUCTANCE Vs CURRENT

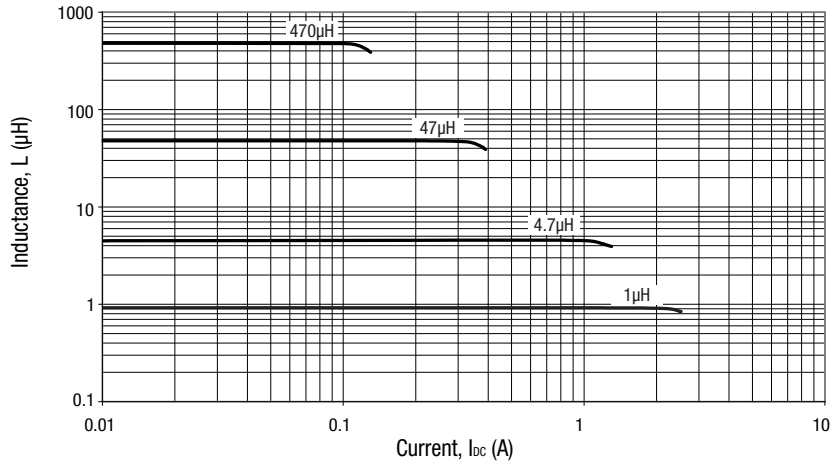

TEMPERATURE Vs CURRENT

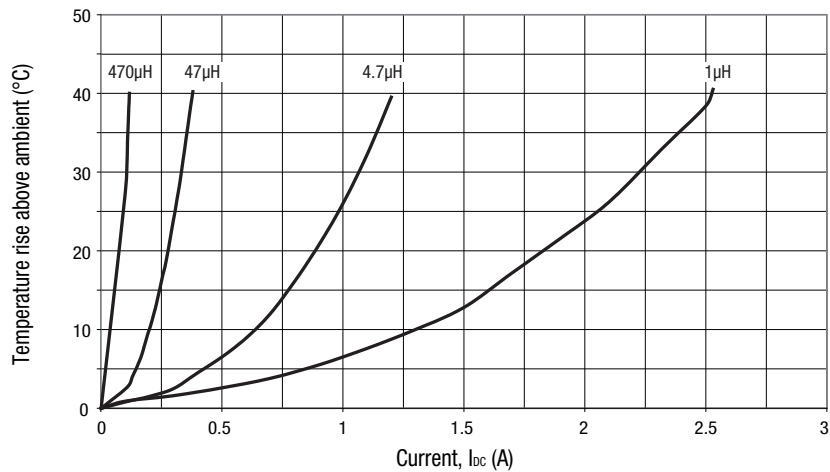

INDUCTANCE Vs FREQUENCY

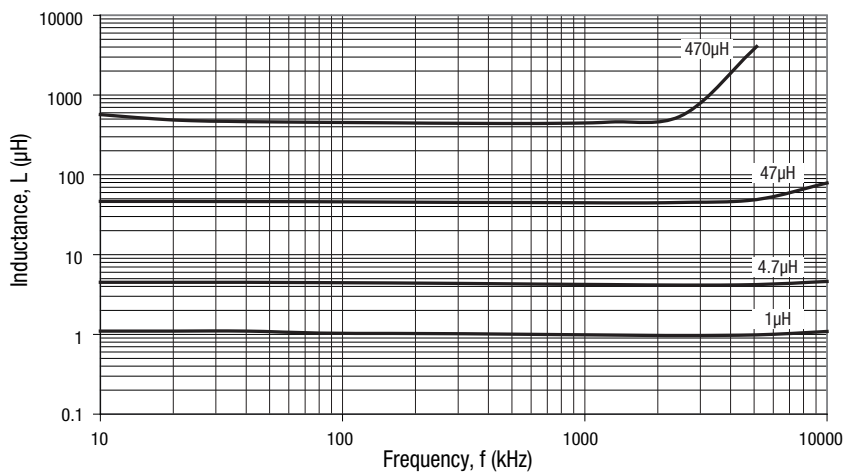

PACKAGE SPECIFICATIONS

MECHANICAL DIMENSIONS

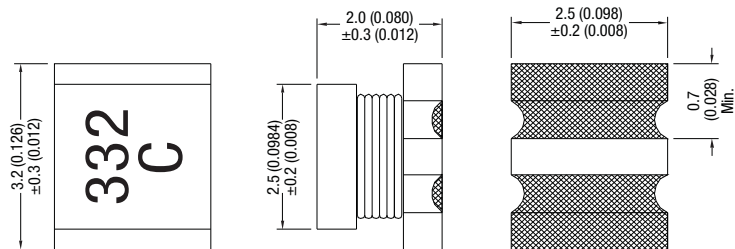

Unless otherwise stated all dimensions in mm (inches) ±0.25 (0.01).
Package Weight 0.06g Typ.

RECOMMENDED FOOTPRINT

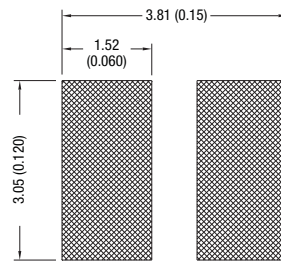

Unless otherwise stated all dimensions in mm (inches) ±0.25 (0.01).

TAPE OUTLINE DIMENSIONS

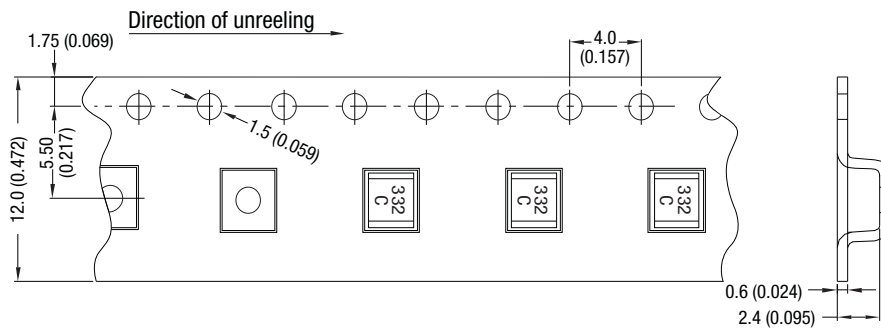

Reel Quantity: 2500
Unless otherwise stated all dimensions in mm (inches)

PACKAGE SPECIFICATIONS (continued)

REEL OUTLINE DIMENSIONS

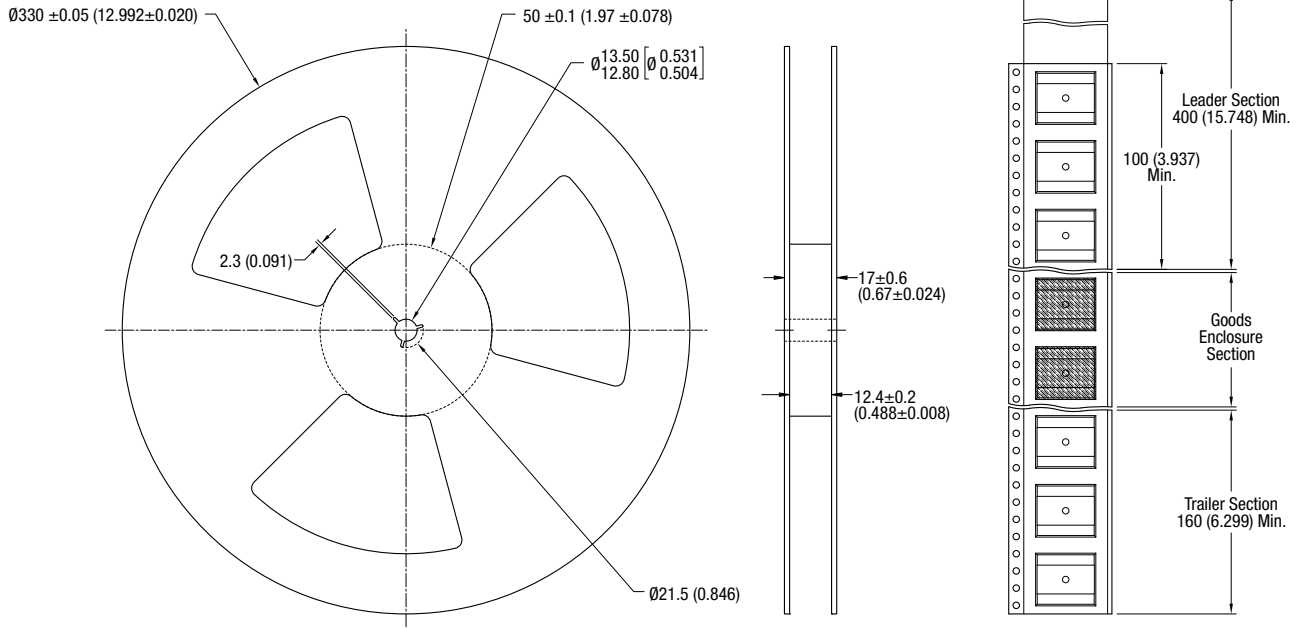

All dimension in mm [inches]
Tape and reel specifications conform with international standards EIA-481-C

Murata Power Solutions, Inc.
11 Cabot Boulevard, Mansfield, MA 02048-1151 U.S.A.
ISO 9001 and 14001 REGISTERED

Murata Power Solutions, Inc. makes no representation that the use of its products in the circuits described herein, or the use of other technical information contained herein, will not infringe upon existing or future patent rights. The descriptions contained herein do not imply the granting of licenses to make, use, or sell equipment constructed in accordance therewith. Specifications are subject to change without notice.
© 2011 Murata Power Solutions, Inc.