

Parameters Subject to Change Without Notice

FEATURES

- Adaptive 100/120Hz current ripple remover
- Input voltage range 5V~60V
- Built-in 60V power MOSFET
- LED voltage low to 0.4V when LED current is 1.3A
- Programmable amplitude of LED current ripple
- Programmable maximum cathode voltage of LED
- Internal LED current limitation
- Short protection
- Hot plug protection
- Over temperature protection
- TO252-5L Package

APPLICATIONS

- LED lightning

DESCRIPTION

SW7230 is used to drive a LED string (<60V), and remove the 100/120Hz current ripple on AC/DC power by a capacitor between VC and GND.

By sensing the LED pin voltage via a resistor divider, SW7230 allows user to setup the maximum cathode voltage of LED string. SW7230 provides voltage limit threshold and short threshold for protection. If the voltage on LED pin exceeds limit threshold, the current ripple removing function is blocked, which could help limit the power dissipation on the chip. It's considered that LED is shorted when LED voltage is higher than short threshold and remains over 0.5 second. The internal MOSFET shuts down when LED is shorted.

SW7230 also provides OPEN and HOT-PLUG protection. The maximum LED current is internally limited at 1.3A. SW7230 provides over thermal protection. When OTP is triggered, the current removing function is blocked, and then the temperature decreases.

TYPICAL APPLICATION

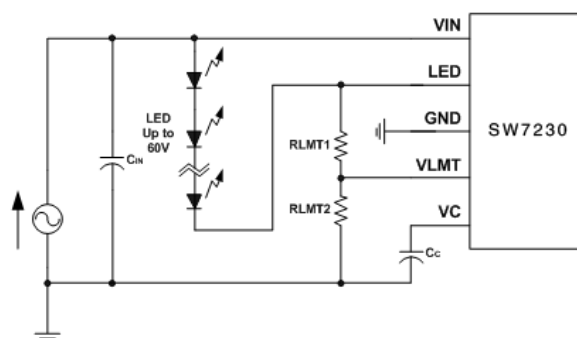

ORDERING INFORMATION

PART MARKING	PACKAGE DESCRIPTION	Top Marking	Package Form
SW7230	TO252-5L	SW7230	

PIN CONFIGURATION

Top View



eSOP8

ABSOLUTE MAXIMUM RATING ¹⁾

VIN PIN	60V
LED PIN	-0.3~60V
VC, VLMT	-0.3V to 6V
Junction Temperature ^{2) 3)}	150°C
Lead Temperature	260 °C
Storage Temperature.....	-65 °C to +150 °C

RECOMMENDED OPERATING RANGE

VIN.....	4.7 to 55V
LED pin	<60V
Maximum Junction Temperature (T _J).....	150°C

THERMAL RESISTANCE θ_{JA} θ_{JC}

TO-252-5L	45°C/W
-----------------	--------

Note:

- 1) Exceeding these ratings may damage the device.
- 2) The SW7230 guarantees robust performance from -40°C to 150°C junction temperature. The junction temperature range specification is assured by design, characterization and correlation with statistical process controls.
- 3) The SW7230 includes thermal protection that is intended to protect the device in overload conditions. Thermal protection is active when junction temperature exceeds the maximum operating junction temperature. Continuous operation over the specified absolute maximum operating junction temperature may damage the device.
- 4) Measured on JESD51-7, 2-layer PCB.

ELECTRICAL CHARACTERISTICS*V_{IN} = 12V, T_A = 25°C, unless otherwise stated.*

Item	Symbol	Condition	Min.	Typ.	Max.	Units
V _{IN} Start Up Voltage Threshold	V _{IN_ON}		3.6	4.0	4.4	V
V _{IN} Operation Current	I _{IN}	I _{LED} =1.0A	0.12	0.20	0.34	mA
LED Voltage Limit Threshold	V _{TH_VLMT}		0.9	1	1.1	V
LED Short Protection Threshold	V _{TH_SHORT}		1.8	2	2.2	V
LED Short Protection Delay	TSP		0.35	0.5	0.65	s
LED Open Protection Threshold	I _{TH_OPEN}			50		mA
LED Open Protection Delay	TOP		0.35	0.5	0.65	s
Regulated LED Pin Voltage	V _{LEDR}	I _{LED} =1.0A	0.25	0.40	0.65	V
LED Current Limit	I _{CLMT}		1.0	1.3	1.6	A
Over thermal protection threshold	OTP		125	135	145	°C

PIN DESCRIPTION

TO-252-5L

Pin No.	Name	Description
1	VIN	Power Supply
2	LED	Connect to Cathode of LED string
3	GND	Power Ground
4	VLMT	LED Voltage Limit Programming
5	VC	LED Current Ripple Programming

TYPICAL PERFORMANCE CHARACTERISTICS

Note: The pre-driver is SW7600 32W T8 program whose output specification is 42V/700mA and the output capacitances choose electrolytic capacitor 960uF. The V_O noted in the figure below refers to the pre-driver output voltage, I_{LED} refers to the output current, V_C refers to the SW7230 VC pin voltage and V_{LED-} refers to the SW7230 LED pin voltage.

Pre-driver output current

(VIN=220V, Io=700mA, Vo=42V, electrolytic capacitor 960uF/63V)

current ripple: 448mA, 64%

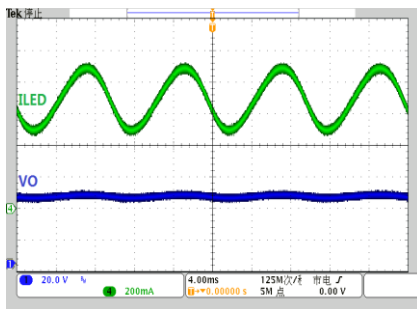

Output current adding SW7230

(VIN=220V, Io=700mA, Vo=42V, electrolytic capacitor 960uF/63V)

current ripple: 18mA, 4%

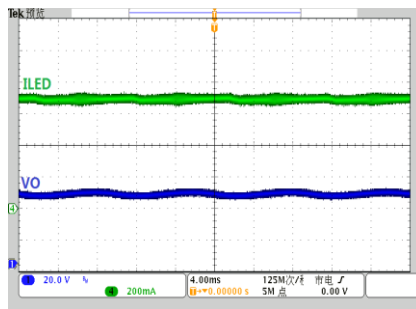

System Efficiency comparison with or without SW7230

(VIN=220V, Io=700mA, Vo=42V, electrolytic capacitor 960uF/63V)

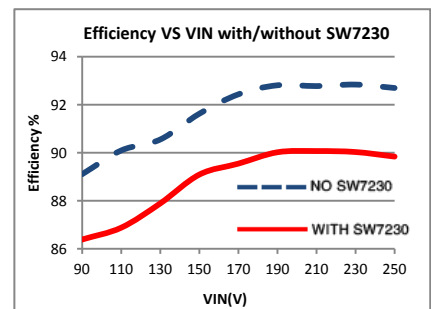

Output Open test

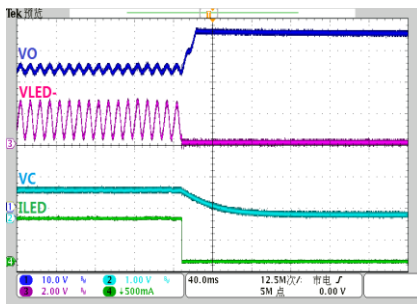

Output Short test

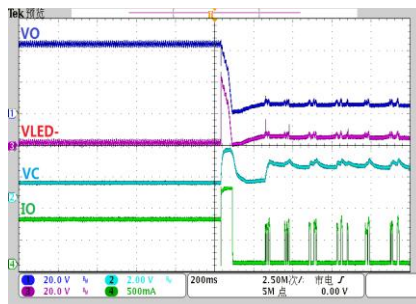

Start up

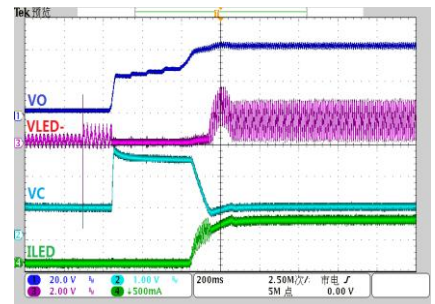

LED hot plug test

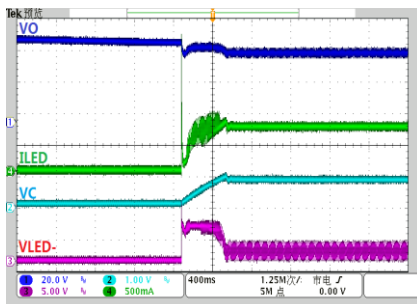

Continuous power on/off test

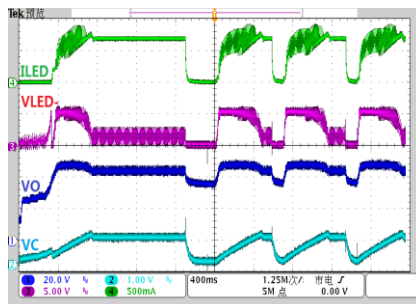

FUNCTIONAL DESCRIPTION

SW7230 is designed for driving one LED string ($\leq 50V$) and removing the 100/120Hz LED current ripple.

Theory of Operation

The LED string and SW7230 are both supplied by an AC/DC current source. The LED pin is connected to the cathode of LED string. SW7230 transfers the LED current ripple to voltage ripple on chip, and ensures the constant voltage across LED string and the current flow through LED string.

The scalable adaptive function of SW7230 can regulate the cathode voltage of LED string to minimum to improve the efficiency of the system.

Current Ripple Removing

The capacitor C_C between VC and GND is a integration capacitor. SW7230 transform the voltage on C_C to a reference voltage. The current regulator regulates LED current via negative feedback control.

The relationship between the voltage on C_C and LED current is shown as following:

$$I_{LED} = V_{VC} * 800 \text{ (mA)}$$

C_C should be large enough in order to remove the current ripple of the LED string. However, too large capacitor may slow down the dynamic response.

Adaptive Regulation

SW7230 control the voltage on C_C by monitoring the operation state of built-in NMOSFET. The efficiency of system is relatively low when NMOSFET is working in the saturation region. SW7230 detects it and charges C_C to raise the V_{VC} and I_{LED} , then the output voltage of power supply is reduced, and the voltage drop on NMOSFET decreases.

Conversely, when NMOSFET is working in the

linear region, LED current regulation loop is open. SW7230 detects it and discharges C_C to reduce the V_{VC} and I_{LED} , then the output voltage of power supply is raised, and the LED current regulation loop is close.

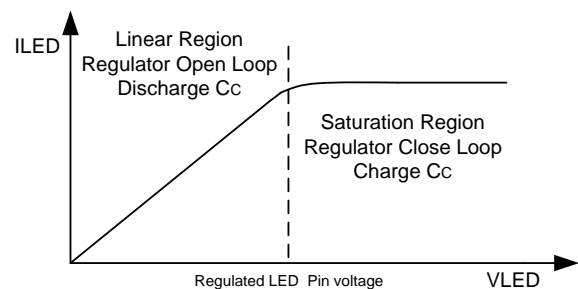

LED Pin Voltage Limit

The voltage ripple on LED pin is very large when the current ripple is removed, which would bring large power dissipation on chip. The resistor divider connected between LED and GND can setup the limit value of LED Pin voltage.

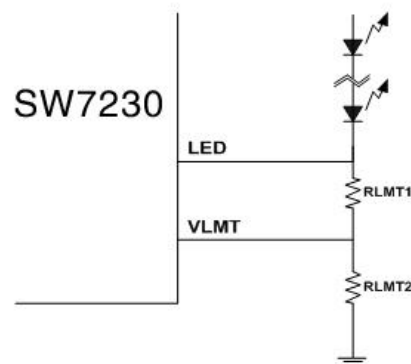

The limit threshold is calculated as below:

$$V_{limit} = 1V * (R_{LMT1} + R_{LMT2}) / R_{LMT2}$$

LED Current Limit

The current of LED is limited at 1.3A internally. The current limitation can protect the chip when LED is short connected or HOT-PLUG.

The function of current limit is higher priority than LED Pin voltage limit. It means that the voltage on LED Pin is limited when LED current exceed 1.3A.

LED Short Protection

When the voltage input to VLMT Pin is exceed 2V and the state holds for more than 0.5 second, SW7230 considers the LED string is SHORT connected, and shut down the internal MOSFET. The shut down state is latched until system restart.

Open and HOT-PLUG Protection

When SW7230 detects that LED current is lower than 50mA, and the state holds for more than 0.5 second, SW7230 considers the LED string is OPEN connected, and shuts down the internal MOSFET. If the LED string is connected suddenly during the OPEN state, the voltage on LED PIN is raised rapidly and exceeds the LED PIN voltage limit threshold. Then the OPEN state is reset,

internal MOSFET is turned on and the LED current is limited at 1.3A.

Over Thermal Protection

SW7230 monitors operation temperature. When the temperature is higher than 140°C, the current ripple removing function is blocked, which could help chip cooling.

Over thermal protection will not be reset until the system restart.

PCB Design Guideline

1. The bypass capacitor of VIN should be placed as close as possible to the VIN pin and GND pin of IC.
2. SW7230 should be placed far away from the power devices such as MOSFET and SBD.
3. The area of LED current loop should be as small as possible.
4. The area of the copper on the PCB will directly affect the temperature rise of IC.

APPLICATION NOTE

SW7230 design guide:

1. Design considerations:
 - a) The withstand voltage of LED pin is 60V, so the overvoltage of the pre-driver must be less than 60V in order to protect the chip in short circuit condition.
 - b) The output should be connected to the LEDs when testing the characteristics of SW7230 including open and short circuit test.
2. The recommended operating current of SW7230 is 0.8A (max 1A). The power loss and temperature rise of the chip depend on the amplitude of the output current ripple and the final amplitude required.
3. Based on the power factor correction of the pre-driver, the law of conservation of energy and the reasonable temperature rise of the SW7230, the output capacitance of the pre-driver can be approximately calculated as follows:
 - P_{IN}: Input power
 - P_{OUT}: Output power
 - P_D: Power loss of SW7230
 - I_{LED}: LED current
 - U: Output voltage
 - V_{MIN}: the minimum LED pin voltage
 - Δ U: Peak to peak output voltage ripple
 - V_{LED-}: LED- pin voltage
 - T: line cycle
 - η: Efficiency of the system
 - a) The power factor correction of the pre-driver and the law of conservation of energy:

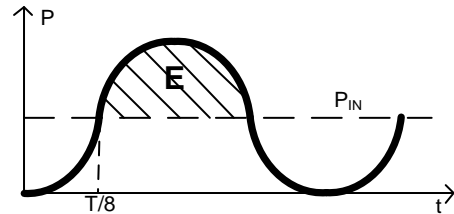

$$P_{IN} = (P_{OUT} + P_D) / \eta \quad \text{..... ①}$$

$$E = 2 \left[P_{IN} * \frac{T}{8} - \int_0^{T/8} P_{IN} (1 - \cos 2\omega t) dt \right] \quad \text{..... ②}$$

b) The energy formula of capacitance:

$$E = \frac{1}{2} * C \left[\left(U + \frac{\Delta U}{2} \right)^2 - \left(U - \frac{\Delta U}{2} \right)^2 \right] \quad \text{..... ③}$$

c) The reasonable temperature rise of the SW7230

$$V_{MIN} = I_{LED} * R_{DS(ON)} \quad \text{..... ④}$$

$$P_D \approx I_{LED} * V_{LED-} \approx I_{LED} * \left(\frac{\Delta U}{2} + V_{MIN} \right) \quad \text{..... ⑤}$$

$$C = \frac{P_{OUT} + P_D}{2 * \pi * f * \eta * P_{OUT} * \Delta U} * I_{LED} \quad \text{..... ⑥}$$

d) The smaller output power, the larger capacitance is needed as it can be seen in the equation above.

e) For example :

- i. Given : P_D=1W (Equivalent to 45°C temperature rise); η=0.85; f=1/T=50Hz

Then,

The result shows in the following figure:

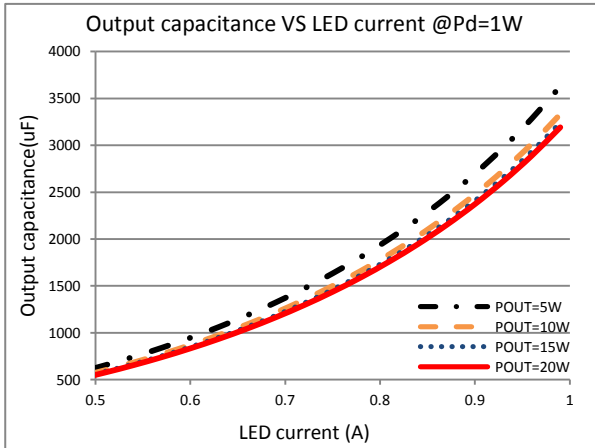

- ii. Given : $P_D=2W$ (Equivalent to $90^\circ C$ temperature rise); $\eta=0.85$;
 $f=1/T=50Hz$

Then the result shows in the below:

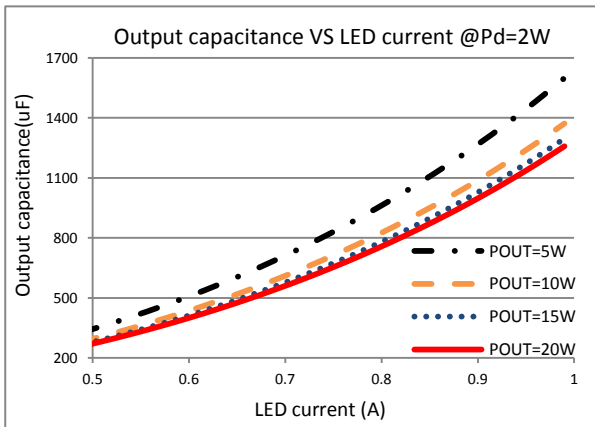

4. By sensing the LED pin voltage via a resistor divider, SW7230 allows user to setup the maximum cathode voltage of LED string.
Because of the voltage limit threshold 1V and the short threshold 2V, the value of the resistance between LED and VLIMIT pin should choose 400K and the other should choose 100K under normal circumstances.
5. The value of the capacitor between VC and GND can determine the final amplitude of the current ripple. It should be large enough in order to remove the current ripple of the LED string. However, too large capacitor may slow down the dynamic response.
In normal condition, 1uF or 2.2uF is reasonable.

APPLICATION REFERENCE

Reference 1:

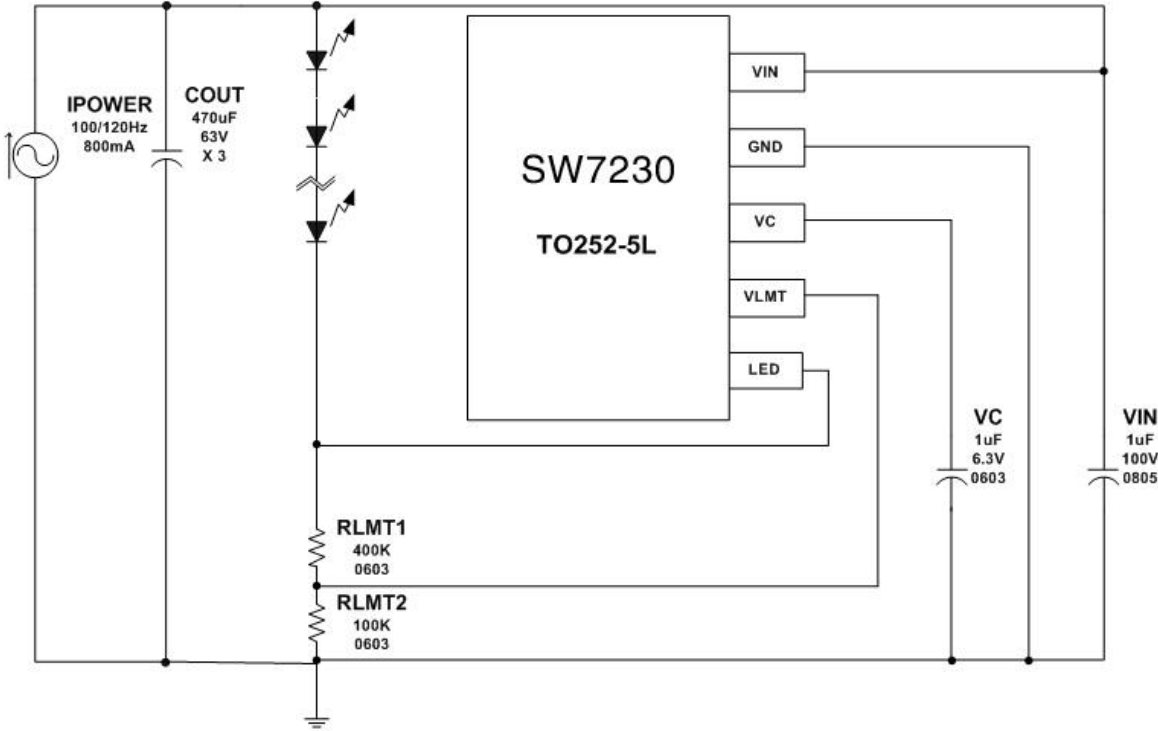

PACKAGE OUTLINE

