

Product Specification

(Preliminary)

Part Name: OEL Display Module

Part ID: UG-2076GDEAF02

Doc No.:

Customer:
Approved by

From: Univision Technology Inc.
Approved by

Univision Technology Inc.

8, Kebei RD 2, Science Park, Chu-Nan, Taiwan 350, R.O.C.

Notes:

1. Please contact Univision Technology Inc. before assigning your product based on this module specification
2. The information contained herein is presented merely to indicate the characteristics and performance of our products. No responsibility is assumed by Univision Technology Inc. for any intellectual property claims or other problems that may result from application based on the module described herein.

Revised History

Part Number	Revision	Revision Content	Revised on
UG-2076GDEAF02	X1	New	September 18, 2006
CONFIDENTIAL			

CONFIDENTIAL

Notice:

No part of this material may be reproduced or duplicated in any form or by any means without the written permission of Univision Technology Inc. Univision Technology Inc. reserves the right to make changes to this material without notice. Univision Technology Inc. does not assume any liability of any kind arising out of any inaccuracies contained in this material or due to its application or use in any product or circuit and, further, there is no representation that this material is applicable to products requiring high level reliability, such as, medical products. Moreover, no license to any intellectual property rights is granted by implication or otherwise, and there is no representation or warranty that anything made in accordance with this material will be free from any patent or copyright infringement of a third party. This material or portions thereof may contain technology or the subject relating to strategic products under the control of Foreign Exchange and Foreign Trade Law of Taiwan and may require an export license from the Ministry of International Trade and Industry or other approval from another government agency.

© Univision Technology Inc. 2006, All rights reserved.

All other product names mentioned herein are trademarks and/or registered trademarks of their respective companies.

Contents

Revision History	<i>i</i>
Notice	<i>ii</i>
Contents	<i>iii</i>
1. Basic Specifications	<i>1~5</i>
1.1 Display Specifications	1
1.2 Mechanical Specifications	1
1.3 Active Area & Pixel Construction.....	1
1.4 Mechanical Drawing	2
1.5 Pin Definition.....	3
1.6 Block Diagram	5
2. Absolute Maximum Ratings	<i>6</i>
3. Electrical Characteristics	<i>7~11</i>
3.1 DC Characteristics.....	7
3.2 AC Characteristics.....	8
3.2.1 68XX-Series MPU Parallel Interface Timing Characteristics	8
3.2.2 80XX-Series MPU Parallel Interface Timing Characteristics	9
3.2.3 Serial Interface Timing Characteristics	10
3.3 Optics & Electrical Characteristics	11
3.4 General Electrical Specification.....	11
4. Functional Specification	<i>12~14</i>
4.1 Commands	12
4.2 Power down and Power up Sequence.....	12
4.2.1 Power up Sequence.....	12
4.2.2 Power down Sequence	12
4.3 Reset Circuit.....	12
4.4 Actual Application Example	13
4.4.1 Driver IC Initial Setting Flowchart.....	13
4.4.2 Reference Parameters Table	14
5. Reliability	<i>15</i>
5.1 Contents of Reliability Tests.....	15
5.2 Lifetime.....	15
5.3 Failure Check Standard.....	15
6. Outgoing Quality Control Specifications	<i>16~20</i>
6.1 Environment Required.....	16
6.2 Sampling Plan	16
6.3 Criteria & Acceptable Quality Level.....	16
6.3.1 Cosmetic Check (Display Off) in Non-Active Area.....	16
6.3.2 Cosmetic Check (Display Off) in Active Area	19
6.3.3 Pattern Check (Display On) in Active Area	20

7. Package Specifications	21
8. Precautions When Using These OEL Display Modules.....	22~24
8.1 Handling Precautions.....	22
8.2 Storage Precautions	23
8.3 Designing Precautions	23
8.4 Precautions when disposing of the OEL display modules.....	23
8.5 Other Precautions	23
9. Appendixes	25~26
9.1 Reference Initial Code	25

CONFIDENTIAL

1. Basic Specifications

1.1 Display Specifications

- 1) Display Mode: Passive Matrix
- 2) Display Color: 262,144 Colors (Maximum)
- 3) Drive Duty: 1/176 Duty

1.2 Mechanical Specifications

- 1) Outline Drawing: According to the annexed outline drawing number
- 2) Number of Pixels: 220 (RGB) × 176
- 3) Panel Size: 54.90 × 41.50 × 1.77 (mm)
- 4) Active Area: 43.535 × 34.803 (mm)
- 5) Pixel Pitch: 0.066 × 0.198 (mm)
- 6) Pixel Size: 0.041 × 0.153 (mm)
- 7) Weight: **TBD** (g)

1.3 Active Area & Pixel Construction

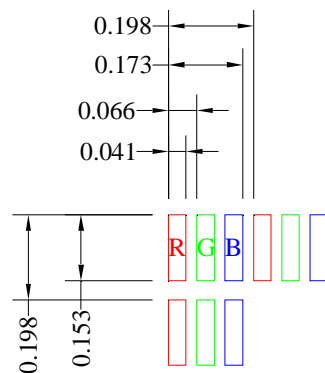
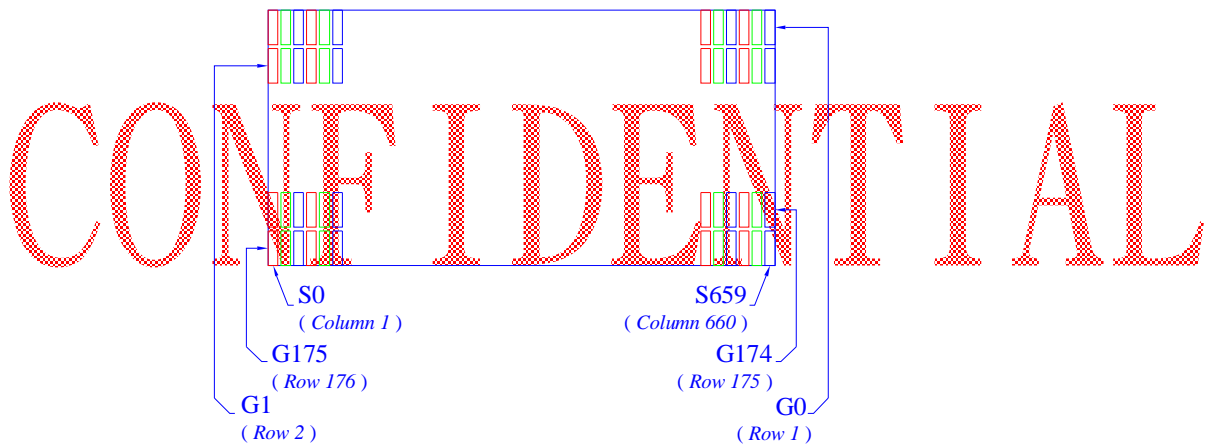

1.4 Mechanical Drawing

Item A	Date 20060911	Remark Original Drawing
-----------	------------------	----------------------------

CONFIDENTIAL

Active Area 2.2" 220(RGB) x 176 Pixels

(Reference Mechanical Design)

Pin	Symbol
1	NC
2	VSDH
3	VSDH
4	VSDH
5	RFB
6	OSCA2
7	OSCA1
8	CPLO
9	PS
10	D15
11	D15
12	D15
13	D15
14	D12
15	D11
16	D10
17	D9
18	DK
19	D7
20	D6
21	D4
22	D4
23	D3
24	D2
25	D1
26	D1
27	RS
28	CSB
29	RDB
30	RDB
31	RESF1B
32	VSS
33	VDI
34	VDI
35	VDDH
36	VSDH
37	NC

Notes:

- Driver IC: SEPS645
- COF Number: SEPS645F01
FPC Number: UT-0864-F01
- Interface:
8-/16-bit 68XX/80XX Parallel, 4-wire SPI
The film terminal use "Sn Plating"
- General Tolerance: ±0.30
- The total thickness (1.77 Max) is without Polarizer Protective film & Remove tape.
The actual assembled total thickness with above materials should be 1.92 Max.

Unless Otherwise Specified	Unit	General Roughness
	mm	$\sqrt{0.3}$

Dimension	±	Angle
Dimension	±0.3	

Signature	Drawn	Panel / E	E-E	By	Date
<i>Signature</i>	Kirin Zhuang	Simon Lee	Simon Lee	Jerry Wang	20060911

Univision Technology Inc.		Title		Material	
UG-2076GDEAF02 Folding Type OEL Display Module		Pixel Number: 220 (RGB) x 176, 262144 Color, COF Package		Soda Lime / Polyimide	
Drawing Number: DHE2076SDF02		Rev. A		Scale	Sheet
				1:1	1 of 1

The drawing contained herein is the exclusive property of Univision. It is not allowed to copy, reproduce and or disclose in any formats without permission of Univision.

1.5 Pin Definition

Pin Number	Symbol	Type	Function
<i>Power Supply Pins</i>			
2,36	VSDH	P	<i>Data Driver Ground</i>
4,34	VSSH	P	<i>Scan Driver Ground</i>
3,35	VDDH	P	<i>Data, Scan Driver Power Supply.</i>
32	VSS	P	<i>Logic Ground</i>
33	VDD.	P	<i>Logic Power Supply.</i>
8	VDDIO	P	<i>MPU I/F PAD Power Supply</i>
<i>System Control Pins</i>			
5	IREF	I	<i>Current Reference for Brightness Adjustment</i> Tie 68K Ω resistor to VSS.
6	OSCA2	O	<i>Fine adjustment for oscillation</i> Tie 10 K Ω resistor to OSCA1 between OSCA2.
7	OSCA1	I	When the external clock mode is selected, OSCA1 is used external clock input.
9	CPU	I	<i>Selects the CPU type</i> Low: 80-series CPU, High: 68-Series CPU.
10	PS	I	<i>Selects parallel/Serial interface type</i> Low: serial, High: parallel.
<i>MPU Interface Pins</i>			
<i>Host Data Input/Output Bus</i> These pins are 16-bit bi-directional data bus to be connected with MCU data bus.			
11~26	D15~D0	I/O	PS
			Description
1	8_bit bus : D[15:8] 16_bit bus : D[15:0]	0	D[15] SCL : Synchronous clock input D[14] SDI : Serial data input D[13] SDO : Serial data output
Fix unused pins to the VSS level.			
27	RS	I	<i>Selects the data/command</i> Low: command, High: parameter/data
28	CSB	I	<i>Chip Select</i> Low: SEPS645 is selected and can be accessed. High: SEPS645 is not selected and cannot be accessed.
29	RDB	I	<i>Read or Read/Write Enable</i> 80-system bus interface: read strobe signal (active low). 68-system bus interface: bus enable strobe (active high). When serial mode, fix it to VDD or VSS level.
30	WRB	I	<i>Write or Read/Write Select</i> 80-system bus interface: write strobe signal (active low). 68-system bus interface: read/write select. Low: write, High: read. When serial mode, fix it to VDD or VSS level.
31	RESETB	I	<i>Chip Reset</i> Reset SEPS645 (active low)

1.5 Pin Definition (Continued)

Pin Number	Symbol	Type	Function
<i>Reserved Pins</i>			
1, 37	NC	-	<i>No Connection</i>

CONFIDENTIAL

1.6 Block Diagram



Active Area 2.2"
220(RGB) x 176 Pixels

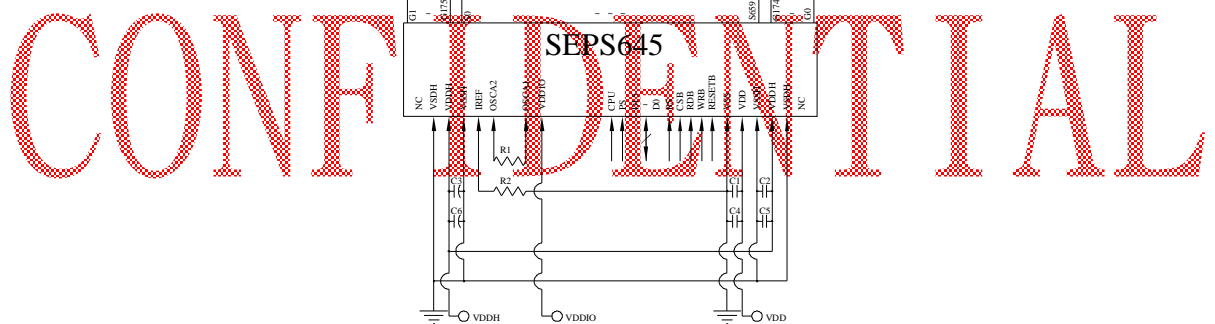

MCU Interface Selection: PS, CPU

Pins connected to MCU interface: D15~D0, RS, CSB, RDB, WRB, RESETB

- C1, C2, C3: 10 μ F
- C4, C5, C6: 0.1 μ F
- R1: 10k Ω
- R2: 68k Ω

2. Absolute Maximum Ratings

Parameter	Symbol	Min	Max	Unit	Notes
Supply Voltage	VDD	-0.3	4	V	1, 2
Supply Voltage for I/O Pins	VDDIO	-0.3	4	V	1, 2
Driver Supply Voltage	VDDH	-0.3	19.5	V	1, 2
Operating Temperature	T _{OP}	-30	70	°C	-
Storage Temperature	T _{STG}	-40	80	°C	-

Note 1: All the above voltages are on the basis of “GND = 0V”.

Note 2: When this module is used beyond the above absolute maximum ratings, permanent breakage of the module may occur. Also, for normal operations, it is desirable to use this module under the conditions according to Section 3. “Electrical Characteristics”. If this module is used beyond these conditions, malfunctioning of the module can occur and the reliability of the module may deteriorate.

CONFIDENTIAL

3. Electrical Characteristics

3.1 DC Characteristics

Characteristics	Symbol	Conditions	Min	Typ	Max	Unit
Supply Voltage	VDD		2.6	2.8	3.3	V
Supply Voltage for I/O Pins	VDDIO		1.6	2.8	3.3	V
Driver Supply Voltage	VDDH		14.5	15.0	15.5	V
High Level Input	V _{IH}		0.8×VDD	-	VDD	V
Low Level Input	V _{IL}		0	-	0.4	V
High Level Output	V _{OH}		VDD-0.4	-	-	V
Low Level Output	V _{OL}		-	-	0.4	V

CONFIDENTIAL

3.2 AC Characteristics

3.2.1 68XX-Series MPU Parallel Interface Timing Characteristics:

(VDD = 2.8V, Ta = 25°C)

Item	Symbol	Condition	Min	Max	Unit	Port
<i>Write Timing</i>						
Address hold timing	t_{AH6}	-	5	-	ns	CSB
Address setup timing	t_{AS6}	-	5	-	ns	RS
System cycle timing	t_{CYC6}	-	100	-	ns	E
Write "L" pulse width	t_{ELW6}	-	45	-	ns	E
Write "H" pulse width	t_{EHW6}	-	45	-	ns	E
Data setup timing	t_{DS6}	-	40	-	ns	DB[15:0]
Data hold Timing	t_{DH6}	-	10	-	ns	DB[15:0]
<i>Read Timing</i>						
Address hold timing	t_{AH6}	-	10	-	ns	CSB
Address setup timing	t_{AS6}	-	10	-	ns	RS
System cycle timing	t_{CYC6}	-	200	-	ns	E
Read "L" pulse width	t_{ELR6}	-	90	-	ns	E
Read "H" pulse width	t_{EHR6}	-	90	-	ns	E
Read data output delay time	t_{RDD6}	$C_L = 15pF$	0	70	ns	DB[15:0]
Data hold Timing	t_{RDH6}	$C_L = 15pF$	0	70	ns	DB[15:0]

*) All the timing reference is 10% and 90% of VDD.

CON

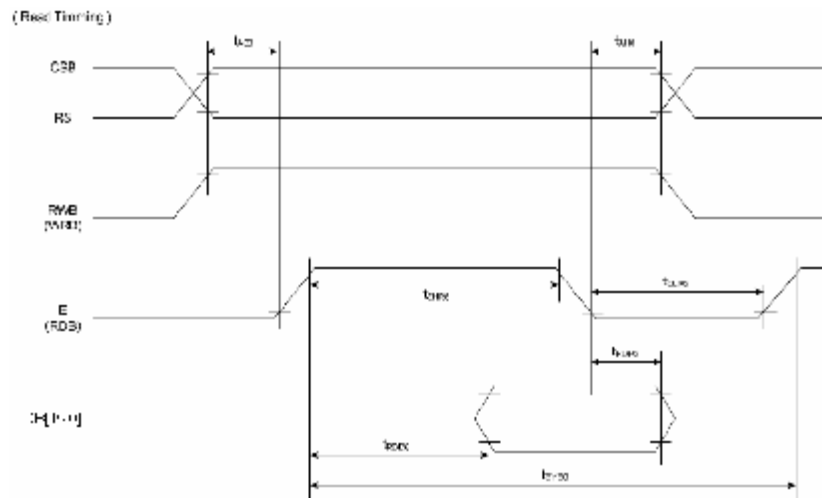
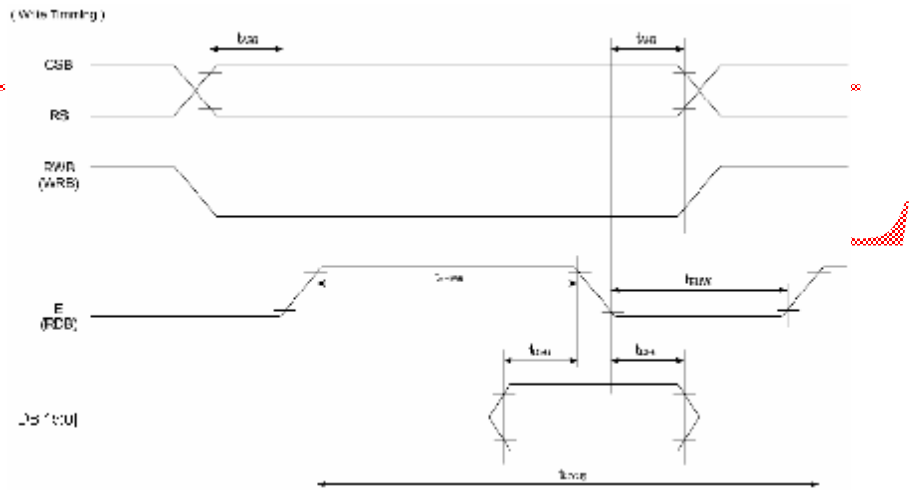

3.2.2 80XX-Series MPU Parallel Interface Timing Characteristics:

(VDD = 2.8V, Ta = 25°C)

Item	Symbol	Condition	Min	Max	Unit	Port
<i>Write Timing</i>						
Address hold timing	t_{AH8}	-	5	-	ns	CSB
Address setup timing	t_{AS8}	-	5	-	ns	RS
System cycle timing	t_{CYC8}	-	100	-	ns	WRB
Write "L" pulse width	t_{WRLW8}	-	45	-	ns	WRB
Write "H" pulse width	t_{WRHW8}	-	45	-	ns	WRB
Data setup timing	t_{DS8}	-	30	-	ns	DB[15:0]
Data hold Timing	t_{DH8}	-	10	-	ns	DB[15:0]
<i>Read Timing</i>						
Address hold timing	t_{AH8}	-	10	-	ns	CSB
Address setup timing	t_{AS8}	-	10	-	ns	RS
System cycle timing	t_{CYC8}	-	200	-	ns	RDB
Read "L" pulse width	t_{RDLR8}	-	90	-	ns	RDB
Read "H" pulse width	t_{RDHR8}	-	90	-	ns	RDB
Read data output delay time	t_{RDD8}	$C_L = 15pF$	-	60	ns	DB[15:0]
Data hold Timing	t_{RDH8}	$C_L = 15pF$	0	-	ns	DB[15:0]

*) All the timing reference is 10% and 90% of VDD.

CON

(Write Timing)

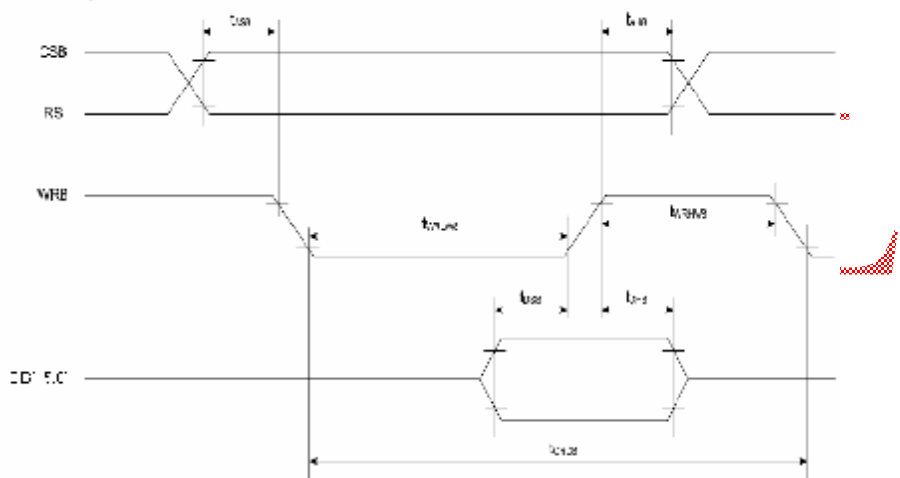

(Read Timing)

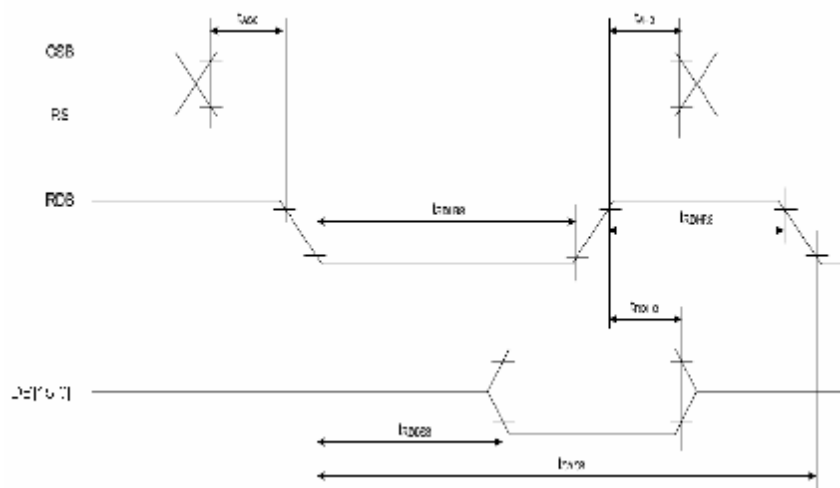

3.2.3 Serial Interface Timing Characteristics:

(VDD = 2.8V, Ta = 25°C)

Item	Symbol	Condition	Min	Max	Unit	Port
Serial clock cycle	t_{CYCS}	-	60	-	-	-
SCL "H" pulse width	t_{SHW}	-	25	-	ns	SCL
SCL "L" pulse width	t_{SLW}	-	25	-	-	-
Data setup timing	t_{DSS}	-	25	-	ns	SDI
Data hold Timing	t_{DHS}	-	25	-	-	-
CSB-SCL timing	t_{CSS}	-	25	-	ns	CSB
CSB-hold timing	t_{CSH}	-	25	-	-	-

*) All the timing reference is 10% and 90% of VDD.

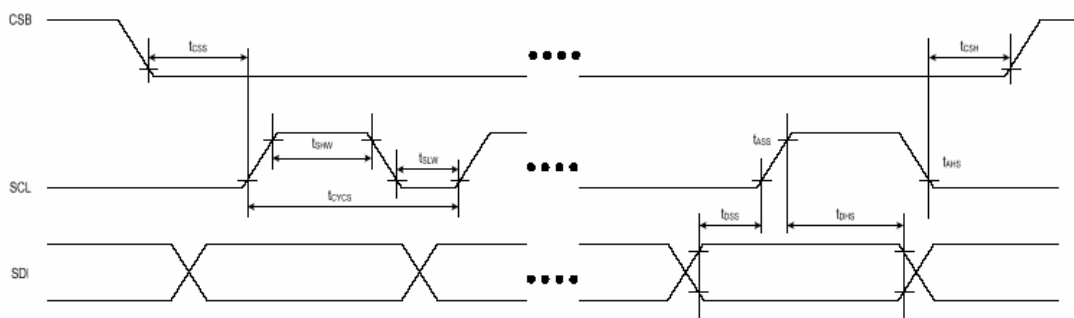

CONFIDENTIAL

3.3 Optics & Electrical Characteristics

Characteristics	Symbol	Conditions	Min	Typ	Max	Unit
Brightness (White)	L_{br}	Note 3	60	80	-	cd/m ²
C.I.E. (White)	(x)	Note 3	0.21	0.25	0.29	
	(y)		0.24	0.28	0.32	
C.I.E. (Red)	(x)	Note 3	0.60	0.64	0.68	
	(y)		0.30	0.34	0.38	
C.I.E. (Green)	(x)	Note 3	0.24	0.28	0.32	
	(y)		0.58	0.62	0.66	
C.I.E. (Blue)	(x)	Note 3	0.11	0.15	0.19	
	(y)		0.15	0.19	0.23	
Dark Room Contrast	CR		-	>1000:1	-	
View Angle			>160	-	-	degree

Note3: Optical measurement with polarizer is taken @ VDD, VDDIO = 2.8V, VDDH = 15V, and the software initial setting **TBD**.

3.4 General Electrical Specification

Characteristics	Symbol	Conditions	Min	Typ	Max	Unit
Supply Voltage	VDD		2.4	2.8	3.3	V
Supply Voltage for I/O Pins	VDDIO		1.6	2.8	3.3	V
Driver Supply Voltage	VDDH		14.5	15.0	15.5	V
Operating Current for VDD	I_{VDD}	Note 4	-	TBD	TBD	mA
		Note 5	-	TBD	TBD	mA
Operating Current for VDDH	I_{VDDH}	Note 4	-	TBD	TBD	mA
		Note 5	-	TBD	TBD	mA
Sleep Mode Current for VDD	$I_{VDD, SLEEP}$		-	TBD	TBD	μA
Sleep Mode Current for VDDH	$I_{VDDH, SLEEP}$		-	TBD	TBD	μA

Note 4: VDD & VDDIO = 2.8V, VDDH = 15V, L_{br} @ 80cd/m², full white with polarizer, software initial setting **TBD**.

Note 5: VDD & VDDIO = 2.8V, VDDH = 15V, L_{br} @ 30cd/m², full white with polarizer, software initial setting **TBD**.

4. Functional Specification

4.1. Commands

Refer to the Technical Manual for the SEPS645

4.2 Power down and Power up Sequence

To protect OEL panel and extend the panel life time, the driver IC power up/down routine should include a delay period between high voltage and low voltage power sources during turn on/off. It gives the OEL panel enough time to complete the action of charge and discharge before/after the operation.

4.2.1 Power up Sequence:

1. Power up VDD, VDDIO
2. Send Display off Command & Initial Setting
3. Clear Screen
4. Power up VDDH
5. Delay 100ms (when VDD is stable)
6. Send Display on Command

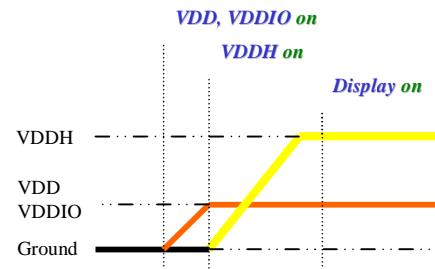

4.2.2 Power down Sequence:

1. Send Display off Command
2. Power down VDDH
3. Delay 100ms (when VDDH is reach 0 and panel is completely discharges)
4. Power down VDD, VDDIO

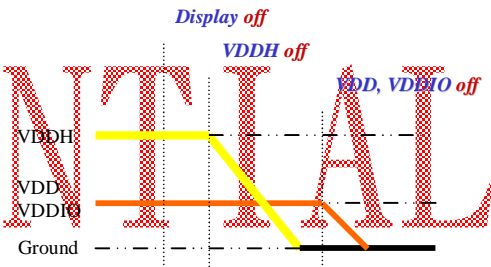

4.3 Reset Circuit

When RESETB input is low, the chip is initialized with the following status:

1. Frame frequency: 90Hz
2. OSC: internal OSC
3. Internal OSC: ON
4. DDRAM write horizontal address: MX1 = 00h, MX2 = DBh
5. DDRAM write vertical address: MY1 = 00h, MY2 = AFh
6. Display data RAM write: HC = 1, VC = 1, HV = 0
7. RGB data swap: OFF
8. Row scan shift direction: G0, G1, ... , G174, G175
9. Column data shift direction: S0, S1, ... , S658, S659
10. Display ON/OFF: OFF
11. Panel display size: FX1 = 00h, FX2 = DBh, FY1 = 00h, FY2 = AFh
12. Display data RAM read column/row address: FAC = 00h, FAR = 00h
13. Precharge time(R/G/B): 0 clock
14. Precharge current(R/G/B): 0 uA
15. Driving current(R/G/B): 0 uA

4.4 Actual Application Example

4.4.1 Driver IC Initial Setting Flowchart

TBD

CONFIDENTIAL

4.4.2 Reference Parameters Table

TBD

CONFIDENTIAL

5. Reliability

5.1 Contents of Reliability Tests

Item	Conditions	Criteria
High Temperature Operation	70°C, 240 hrs	The operational functions work.
Low Temperature Operation	-30°C, 240 hrs	
High Temperature Storage	80°C, 240 hrs	
Low Temperature Storage	-40°C, 240 hrs	
High Temperature/Humidity Operation	60°C, 90% RH, 120 hrs	
Thermal Shock	-40°C \leftrightarrow 85°C, 24 cycles 1 hr dwell	

* The samples used for the above tests do not include polarizer.

* No moisture condensation is observed during tests.

5.2 Lifetime

End of lifetime is specified as 50% of initial brightness.

Parameter	Min	Max	Unit	Condition	Notes
Operating Life Time	10,000	-	Hrs	60 cd/m ² , 50% checkerboard	6
Storage Life Time	20,000	-	Hrs	T _a =25°C, 50%RH	-

Note 6: The average operating lifetime at room temperature is estimated by the accelerated operation at high temperature conditions.

5.3 Failure Check Standard

After the completion of the described reliability test, the samples were left at room temperature for 2 hrs prior to conducting the failure test at 23±5°C; 55±15% RH.

6. Outgoing Quality Control Specifications

6.1 Environment Required

Customer's test & measurement are required to be conducted under the following conditions:

Temperature:	23 ± 5°C
Humidity:	55 ± 15 %RH
Fluorescent Lamp:	30W
Distance between the Panel & Lamp:	≥ 50 cm
Distance between the Panel & Eyes of the Inspector:	≥ 30 cm
Finger glove (or finger cover) must be worn by the inspector.	
Inspection table or jig must be anti-electrostatic.	

6.2 Sampling Plan

Level II, Normal Inspection, Single Sampling, MIL-STD-105E



6.3 Criteria & Acceptable Quality Level

Partition	AQL	Definition
Major	0.65	Defects in Pattern Check (Display On)
Minor	1.0	Defects in Cosmetic Check (Display Off)

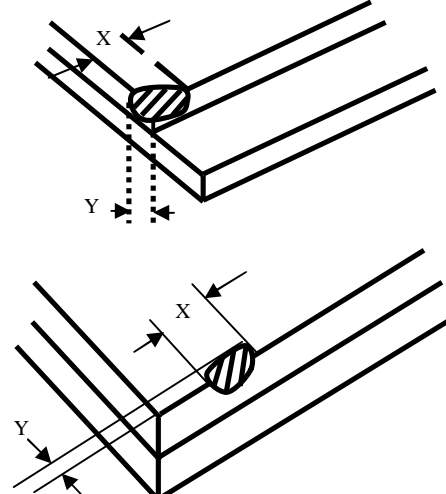
6.3.1 Cosmetic Check (Display Off) in Non-Active Area

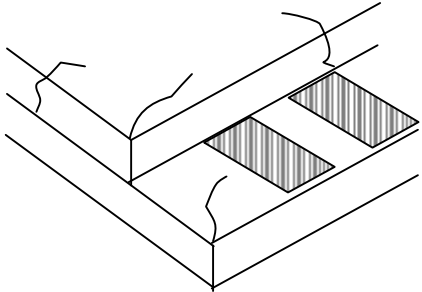

Check Item	Classification	Criteria
Panel General Chipping	Minor	<p>X > 6 mm (Along with Edge) Y > 1 mm (Perpendicular to edge)</p> 

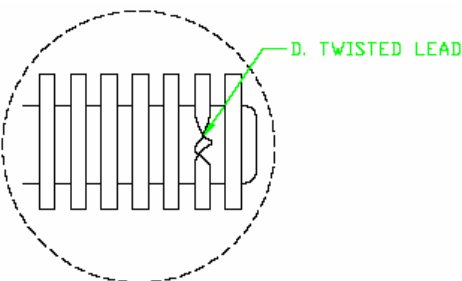
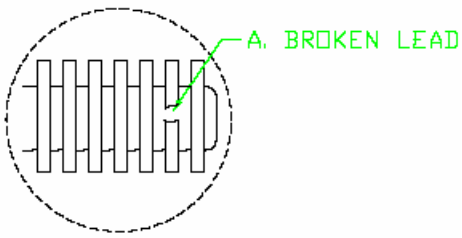
6.3.1 Cosmetic Check (Display Off) in Non-Active Area (Continued)

Check Item	Classification	Criteria
Panel Crack	Minor	Any crack is not allowable. 
Copper Exposed (Even Pin or Film)	Minor	Not Allowable by Naked Eye Inspection
Film or Trace Damage	Minor	
Terminal Lead Twist	Minor	Not Allowable 
Terminal Lead Broken	Minor	Not Allowable 
Terminal Lead Probe Mark	Acceptable	Ok

CONFIDENTIAL

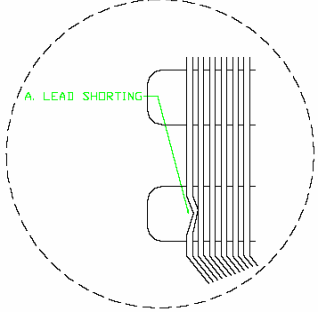
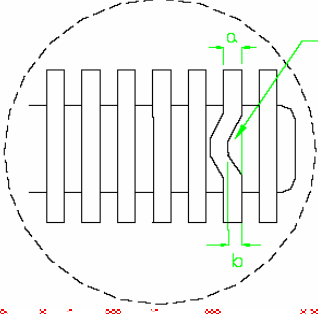
6.3.1 Cosmetic Check (Display Off) in Non-Active Area (Continued)

Check Item	Classification	Criteria
Terminal Lead Bent (Not Twist or Broken)	Minor	<p>NG if any bent lead cause lead shorting.</p> 
	Minor	<p>NG for horizontally bent lead more than 50% of its width.</p> 
Glue or Contamination on Pin (Couldn't Be Removed by Alcohol)	Minor	
Ink Marking on Back Side of panel (Exclude on Film)	Acceptable	Ignore for Any

CONFIDENTIAL

6.3.2 Cosmetic Check (Display Off) in Active Area

It is recommended to execute in clear room environment (class 10k) if actual in necessary.

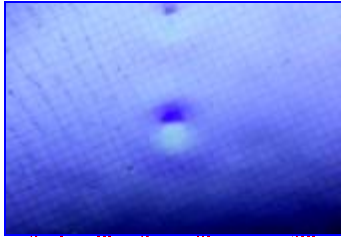
Check Item	Classification	Criteria
Any Dirt & Scratch on Protective Film	Acceptable	Ignore for Any
Scratches, Fiber, Line-Shape Defect (On Polarizer)	Minor	$W \leq 0.1$ Ignore
		$W \leq 0.1$ Ignore
		$W > 0.1, L \leq 1$ $n \leq 1$
		$L > 1$ $n = 0$
Dirt, Spot-Shape Defect (On Polarizer)	Minor	$\Phi \leq 0.1$ Ignore $0.1 < \Phi \leq 0.2$ $n \leq 1$ $0.2 < \Phi$ $n = 0$
Dent, Bubbles, White spot (Any Transparent Spot on Polarizer)	Minor	$\Phi \leq 0.5$ Ignore if no Influence on Display $0.5 < \Phi$ $n = 0$ 
Fingerprint, Flow Mark (On Polarizer)	Minor	Not allowable



CONFIDENTIAL

* Protective film should not be tear off when cosmetic check.

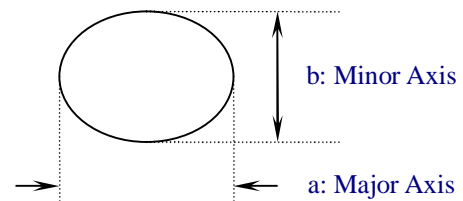
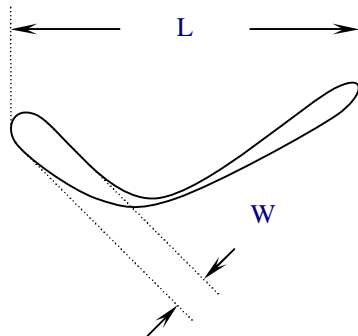
** Definition of W & L & Φ (Unit: mm): $\Phi = (a + b) / 2$

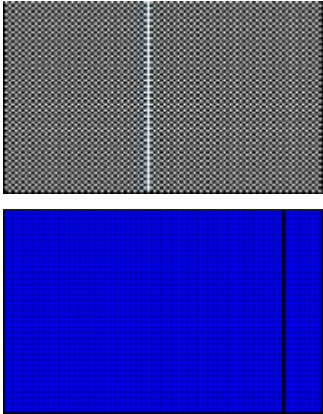
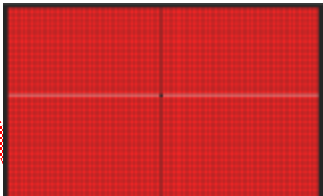
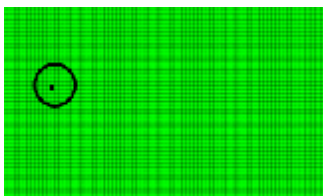
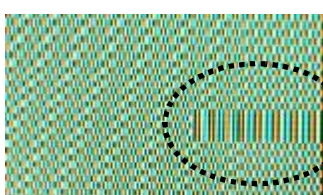

6.3.3 Pattern Check (Display On) in Active Area

Check Item	Classification	Criteria
No Display	Major	Not allowable
Bright Line	Major	
Missed Line	Major	
Pixel Short	Major	
Darker Pixel	Major	
Wrong Display	Major	
Un-Uniform (Luminance Variation within a Display)	Major	

CONFIDENTIAL

7. Package Specifications

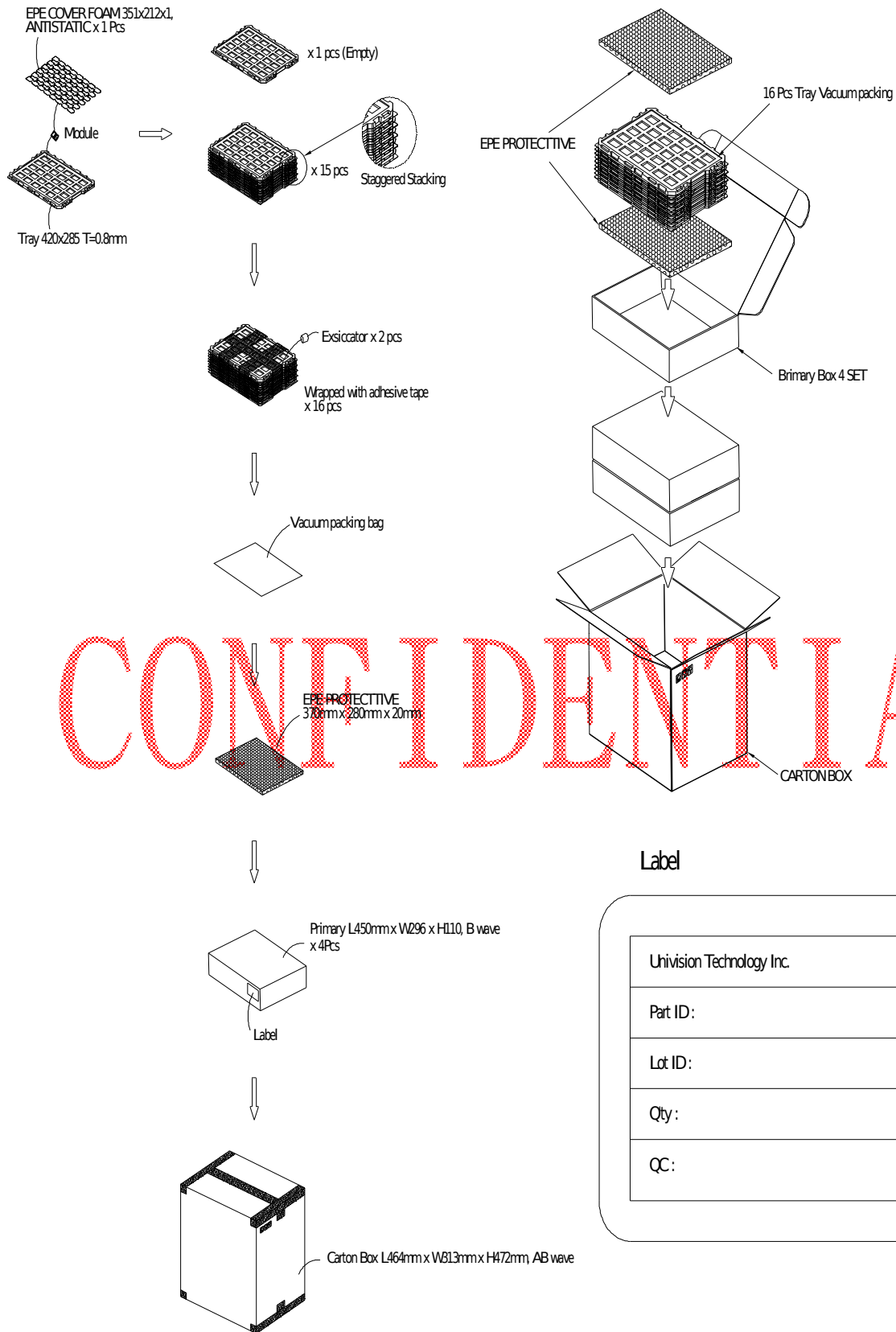

Label

Univision Technology Inc.
Part ID:
Lot ID:
Qty:
QC:

8. Precautions When Using These OEL Display Modules**8.1 Handling Precautions**

- 1) Since the display panel is being made of glass, do not apply mechanical impacts such as dropping from a high position.
- 2) If the display panel is broken by some accident and the internal organic substance leaks out, be careful not to inhale nor lick the organic substance.
- 3) If pressure is applied to the display area, both of top and back sides, or its neighborhood of the OEL display module, the cell structure may be damaged and be careful not to touch these sections on carrying and assembly.
- 4) The polarizer covering the surface of the OEL display module is soft and easily scratched. Please be careful when handling the OEL display module.
- 5) When the surface of the polarizer of the OEL display module has soil, clean the surface. It takes advantage of by using following adhesion tape.
 - * Scotch Mending Tape No. 810 or an equivalentNever try to breathe upon the soiled surface nor wipe the surface using cloth containing solvent such as ethyl alcohol, since the surface of the polarizer will become cloudy.
Also, pay attention that the following liquid and solvent may spoil the polarizer:
 - * Water
 - * Ketone
 - * Aromatic Solvents
- 6) When installing the OEL display module, be careful not to apply twisting stress or deflection stress to the OEL display module. And, do not over bend the film with electrode pattern layouts. These stresses will influence the display performance. Also, secure sufficient rigidity for the outer cases.
- 7) Do not apply stress to the LSI chips and the surrounding molded sections.
- 8) Do not disassemble nor modify the OEL display module.
- 9) Do not apply input signals while the logic power is off.
- 10) Pay sufficient attention to the working environments when handling OEL display modules to prevent occurrence of element breakage accidents by static electricity.
 - * Be sure to make human body grounding when handling OEL display modules.
 - * Be sure to ground tools to use or assembly such as soldering irons.
 - * To suppress generation of static electricity, avoid carrying out assembly work under dry environments.
 - * Protective film is being applied to the surface of the display panel of the OEL display module. Be careful since static electricity may be generated when exfoliating the protective film.
- 11) Protection film is being applied to the surface of the display panel and removes the protection film before assembling it. At this time, if the OEL display module has been stored for a long period of time, residue adhesive material of the protection film may remain on the surface of the display panel after removed of the film. In such case, remove the residue material by the method introduced in the above Section 5).
- 12) If electric current is applied when the OEL display module is being dewed or when it is placed under high humidity environments, the electrodes may be corroded and be careful to avoid the above.

8.2 Storage Precautions

- 1) When storing OEL display modules, put them in static electricity preventive bags avoiding exposure to direct sun light nor to lights of fluorescent lamps, etc. and, also, avoiding high temperature and high humidity environments or low temperature (less than 0°C) environments. (We recommend you to store these modules in the packaged state when they were shipped from Univision Technology Inc.)

At that time, be careful not to let water drops adhere to the packages or bags nor let dewing occur with them.

- 2) If electric current is applied when water drops are adhering to the surface of the OEL display module, when the OEL display module is being dewed or when it is placed under high humidity environments, the electrodes may be corroded and be careful about the above.

8.3 Designing Precautions

- 1) The absolute maximum ratings are the ratings which cannot be exceeded for OEL display module, and if these values are exceeded, panel damage may be happen.
- 2) To prevent occurrence of malfunctioning by noise, pay attention to satisfy the VIL and VIH specifications and, at the same time, to make the signal line cable as short as possible.
- 3) We recommend you to install excess current preventive unit (fuses, etc.) to the power circuit (VDD). (Recommend value: 0.5A)
- 4) Pay sufficient attention to avoid occurrence of mutual noise interference with the neighboring devices.
- 5) As for EMI, take necessary measures on the equipment side basically.
- 6) When fastening the OEL display module, fasten the external plastic housing section.
- 7) If power supply to the OEL display module is forcibly shut down by such errors as taking out the main battery while the OEL display panel is in operation, we cannot guarantee the quality of this OEL display module.
- 8) The electric potential to be connected to the rear face of the IC chip should be as follows: SSPS645
* Connection (contact) to any other potential than the above may lead to rupture of the IC.

8.4 Precautions when disposing of the OEL display modules

- 1) Request the qualified companies to handle industrial wastes when disposing of the OEL display modules. Or, when burning them, be sure to observe the environmental and hygienic laws and regulations.

8.5 Other Precautions

- 1) When an OEL display module is operated for a long of time with fixed pattern may remain as an after image or slight contrast deviation may occur. Nonetheless, if the operation is interrupted and left unused for a while, normal

- state can be restored. Also, there will be no problem in the reliability of the module.
- 2) To protect OEL display modules from performance drops by static electricity rapture, etc., do not touch the following sections whenever possible while handling the OEL display modules.
 - * Pins and electrodes
 - * Pattern layouts such as the COF
 - 3) With this OEL display module, the OEL driver is being exposed. Generally speaking, semiconductor elements change their characteristics when light is radiated according to the principle of the solar battery. Consequently, if this OEL driver is exposed to light, malfunctioning may occur.
 - * Design the product and installation method so that the OEL driver may be shielded from light in actual usage.
 - * Design the product and installation method so that the OEL driver may be shielded from light during the inspection processes.
 - 4) Although this OEL display module stores the operation state data by the commands and the indication data, when excessive external noise, etc. enters into the module, the internal status may be changed. It therefore is necessary to take appropriate measures to suppress noise generation or to protect from influences of noise on the system design.
 - 5) We recommend you to construct its software to make periodical refreshment of the operation statuses (re-setting of the commands and re-transference of the display data) to cope with catastrophic noise.

CONFIDENTIAL

9. Appendixes

9.1 Reference Initial Code

```
//Reg:04h Action:Normal current and PS ON / Internal oscillator power off
Write_Command(rREDUCE_CURRENT,0x03);
T0_05sec();

//Reg:04h Action:Normal current and PS OFF
Write_Command(rREDUCE_CURRENT,0x00);
T0_05sec();

//Reg:3Bh Action:Screen Saver OFF
Write_Command(rSCREEN_SAVER_CONTEROL,0x00);

//Reg:02h Action:Export 0 /OSC with external resister/Internal OSC ON
Write_Command(rOSC_CTL,0x41);

//Reg:03h Action:FR=90Hz DIV=1
Write_Command(rCLOCK_DIV,0x30);

//Reg:80h Action:PDAC OFF,DDAC OFF/Reference Volt.control with external resister
Write_Command(rIREF,0x00);

//Reg:07h Action:set discharge time
Write_Command(rDISCHARGE_TIME,0x00);

//Reg:08h Action:set color R precharge time
Write_Command(rPRECHARGE_TIME_R,0x02);

//Reg:09h Action:set color G precharge time
Write_Command(rPRECHARGE_TIME_G,0x02);

//Reg:0Ah Action:set color B precharge tiem
Write_Command(rPRECHARGE_TIME_B,0x02);

//Reg:0Bh Action:set color R precharge current
Write_Command(rPRECHARGE_Current_R,0x00);

//Reg:0Ch Action:set color G precharge current
Write_Command(rPRECHARGE_Current_G,0x00);

//Reg:0Dh Action:set color B precharge current
Write_Command(rPRECHARGE_Current_B,0x00);

//Reg:10h Action:set color R dot driving current
Write_Command(rDRIVING_CURRENT_R,0x80);

//Reg:11h Action:set color G dot driving current
Write_Command(rDRIVING_CURRENT_G,0x80);

//Reg:12h Action:set color B dot driving current
Write_Command(rDRIVING_CURRENT_B,0x80);

//Reg:13h Action:Col D0 to D159/col normal display
Write_Command(rDISPLAY_MODE_SET,0x00);

//Reg:14h Action:MPU mode
Write_Command(rRGB_IF,0x31);

//Reg:16h Action: 6btis triple transfer,262K support
Write_Command(rMEMORY_WRITE_MODE,0x76);

//Reg:17h Action:Memory addr.X start
Write_Command(rMX1_ADDR,0x00);

//Reg:18h Action:Memory addr.X end
Write_Command(rMX2_ADDR,0xdb);
```

CONFIDENTIAL

```
//Reg:19h Action:Memory addr.Y start
Write_Command(rMY1_ADDR,0x00);

//Reg:1Ah Action:Memory addr.Y end
Write_Command(rMY2_ADDR,0xaf);

//Reg:20h Action:Memory X start addr.
Write_Command(rMEMORY_ACCESS_POINTER_X,0x00);

//Reg:21h Action:Memory Y start addr.
Write_Command(rMEMORY_ACCESS_POINTER_Y,0x00);

//Reg:28h Action:Display duty ratio
Write_Command(rDUTY,0xaf);

//Reg:29h Action:Display start line
Write_Command(rDSL,0x00);

//Reg:2Eh Action:Display First screen X start point
Write_Command(rD1_DDRAM_FAC,0x00);

//Reg:2Fh Action:Display First screen Y start point
Write_Command(rD1_DDRAM_FAR,0x00);

//Reg:31h Action:Display Second screen X start point
Write_Command(rD2_DDRAM_SAR,0x00);

//Reg:32h Action:Display Second screen Y start point
Write_Command(rD2_DDRAM_SAR,0x00);

//Reg:33h Action:Display size X start
Write_Command(rSCR1_FX1,0x00);

//Reg:34h Action:Display size X end
Write_Command(rSCR1_FX2,0xdb);

//Reg:35h Action:Display size Y start
Write_Command(rSCR1_FY1,0x00);

//Reg:36h Action:Display size Y end
Write_Command(rSCR1_FY2,0xaf);

//Reg:06h Action:Scan signal is high level at precharge period/Dispaly ON
Write_Command(rDISP_ON_OFF,0x01);
```

CONFIDENTIAL