

FEATURES

- 15 dB Gain
- +5 V Nominal Supply Voltage
- High Linearity
- Low Noise Figure: 2.7 dB (typ.)
- Characterized at +25 dBmV output power
- Wide Band operation to 870 MHz
- Shutdown Mode
- -40 to +85 °C
- RoHS-Compliant Package

APPLICATIONS

- Driver Amplifier
- CATV - Distribution / Drop Amplifiers
- Set Top Boxes
- Home Gateway

PRODUCT DESCRIPTION

The ABA3115 is a monolithic IC intended for use in applications requiring high linearity, such as Cellular Telephone Base Station Driver Amplifiers, CATV Fiber Receiver and Distribution Amplifiers, CATV Drop Amplifiers, CATV Set Top Boxes and Home Gateways. Offered in a modified 16 lead surface mount SOIC



package that is RoHS-Compliant, it is well suited for use in amplifiers where small size, reduced component count, and high reliability are important. The ABA3115 incorporates a shutdown feature under logic control whereby power consumption is reduced to 15 mW with a +5 V supply.

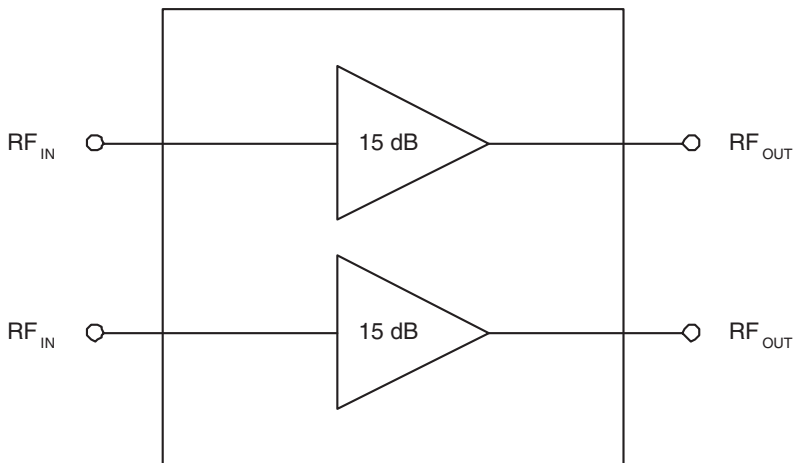

Figure 1: Block Diagram

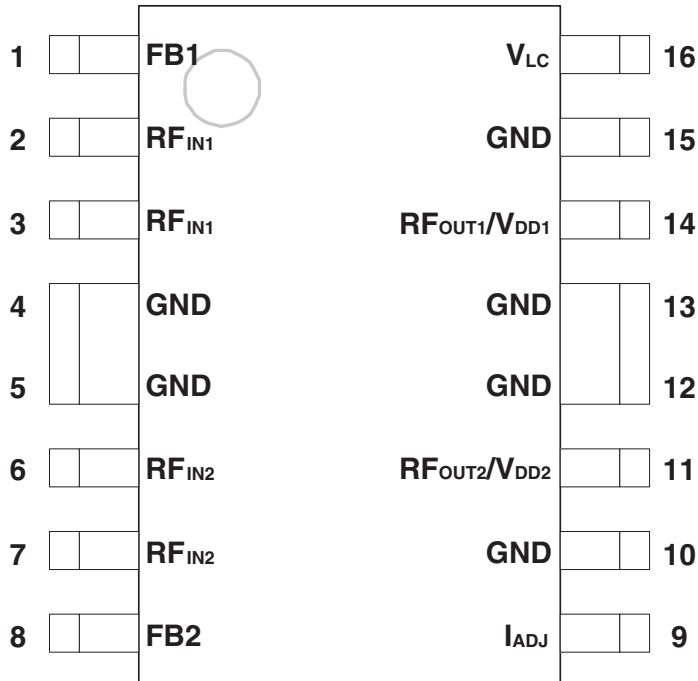

Figure 2: Pin Out

Table 1: Pin Description

PIN	NAME	DESCRIPTION	PIN	NAME	DESCRIPTION
1	FB1	Feedback for Amplifier A1	9	I _{ADJ}	Current Adjust
2	RF _{IN1}	RF Input of Amplifier A1	10	GND	Ground
3	RF _{IN1}	RF Input of Amplifier A1	11	RF _{OUT2} /V _{DD2}	RF output and VDD of Amplifier A2
4	GND	Ground	12	GND	Ground
5	GND	Ground	13	GND	Ground
6	RF _{IN2}	RF Input of Amplifier A2	14	RF _{OUT1} /V _{DD1}	RF output and VDD of Amplifier A1
7	RF _{IN2}	RF Input of Amplifier A2	15	GND	Ground
8	FB2	Feedback for Amplifier A2	16	V _{LC}	Shutdown Logic Control

ELECTRICAL CHARACTERISTICS

Table 2: Absolute Minimum and Maximum Ratings

PARAMETER	MIN	MAX	UNIT
Analog Supply (pins 11, 14)	0	+12	V _{DC}
Shutdown Logic Control (pin 16)	0	+6	V _{DC}
RF Power at Inputs (pins 2, 3, 6, 7)	-	+10	dBm
Storage Temperature	-65	+150	°C
Soldering Temperature	-	260	°C
Soldering Time	-	5	sec

Stresses in excess of the absolute ratings may cause permanent damage. Functional operation is not implied under these conditions. Exposure to absolute ratings for extended periods of time may adversely affect reliability.

Notes:

1. Pins 1, 2, 3, 6, 7 and 8 should be AC-coupled. No external DC bias should be applied.
2. Pin 9 should be AC-grounded. No external DC bias should be applied.

Table 3: Operating Ranges

PARAMETER	MIN	TYP	MAX	UNIT
RF Input / Output Frequency	50	-	870	MHz
Analog Supply: V _{DD} (pins 11, 14)	+4.5	+5	+9	V _{DC}
Shutdown Logic Control: V _{LC} (pin 16)	0	-	+6	V
Case Temperature: T _A	-40	-	+85	°C

The device may be operated safely over these conditions; however, parametric performance is guaranteed only over the conditions defined in the electrical specifications.

Table 4: Electrical Specifications
 (T_A = +25 °C, V_{DD} = + 5 VDC, V_{LC} = +5 V, Test System = 75Ω)

PARAMETER	MIN	TYP	MAX	UNIT	COMMENTS
Gain	14	15	17	dB	
Noise Figure	-	2.5	3.0	dB	50 - 350 MHz
	-	2.7	3.5		350 - 550 MHz
	-	3.2	4.0		550 - 860 MHz
Input / Output Return Loss	10	18	-	dB	
CSO ⁽¹⁾	-	-72	-70	dBc	
CTB ⁽¹⁾	-	-75	-73	dBc	
2nd Order Output Intercept Point (OIP2) ⁽²⁾	-	+60	-	dBm	
3rd Order Output Intercept Point (OIP3) ⁽²⁾	-	+35	-	dBm	
Thermal Resistance	-	-	33	°C/W	
Current Consumption ⁽³⁾⁽⁴⁾	120 -	150 3	170 -	mA	V _{LC} = +5 V V _{LC} = 0 V

Notes:

(1) 132 channels, +25 dBmV per channel (measured at the output), 6 MHz channel spacing

(2) Two tones: 397 MHz and 403 MHz, +4 dBm per tone

(3) Characterized with I_{ADJ} pin floating.

(4) Adding a shunt resistor from the I_{ADJ} pin to ground will lower current but with some decrease in performance.

Table 5: Shutdown Logic Control State Table

STATUS	V _{LC}	AMPLIFIER	AMPLIFIER BIAS CURRENT
Power up	+5 V	ON	150 mA
Shutdown	0 V	OFF	3 mA

PERFORMANCE DATA

Figure 3: Typical Gain (S21) vs. Frequency

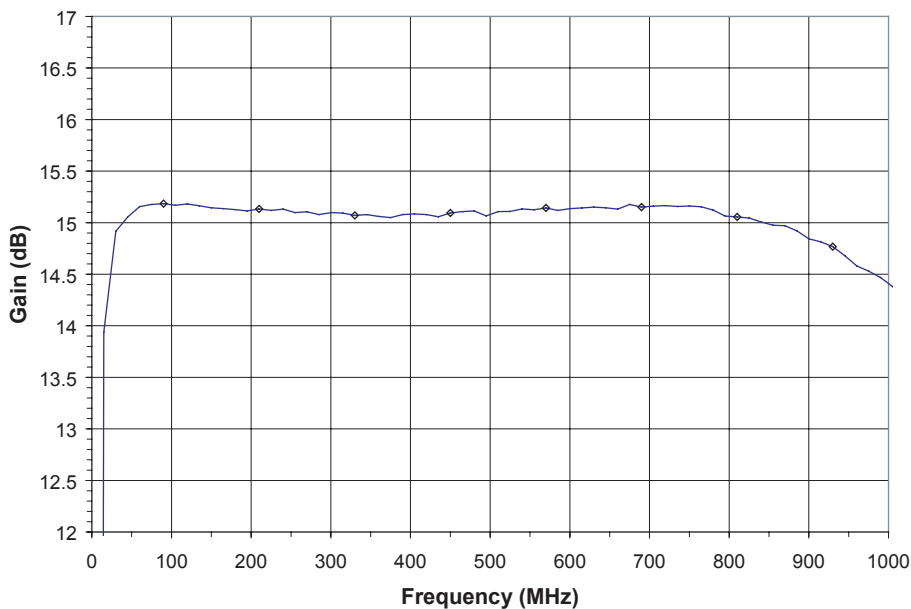

Figure 4: Typical Input and Output Return Loss (S11 and S22) vs. Frequency

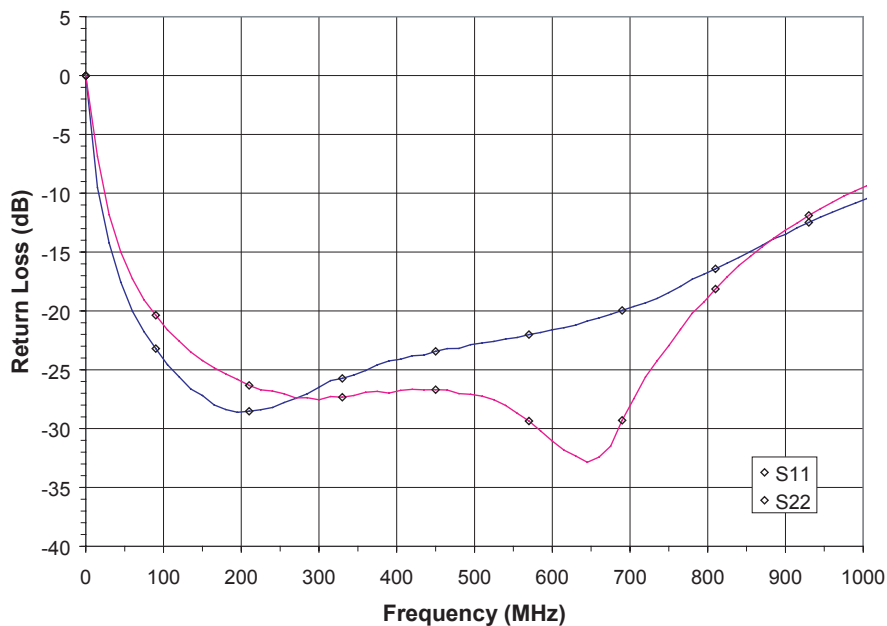

Figure 5: Typical Isolation (S12) vs. Frequency

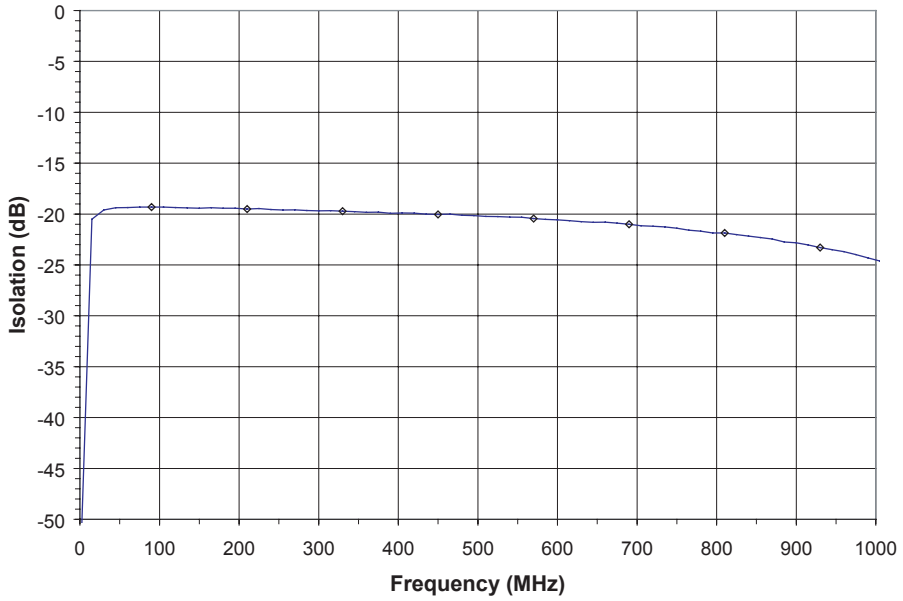
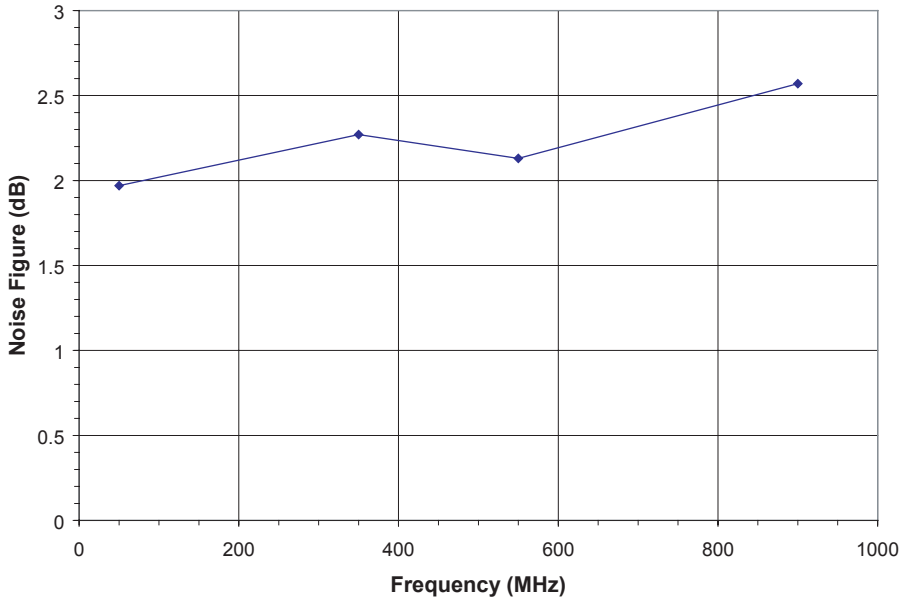

Figure 6: Typical Noise Figure vs. Frequency



APPLICATION INFORMATION

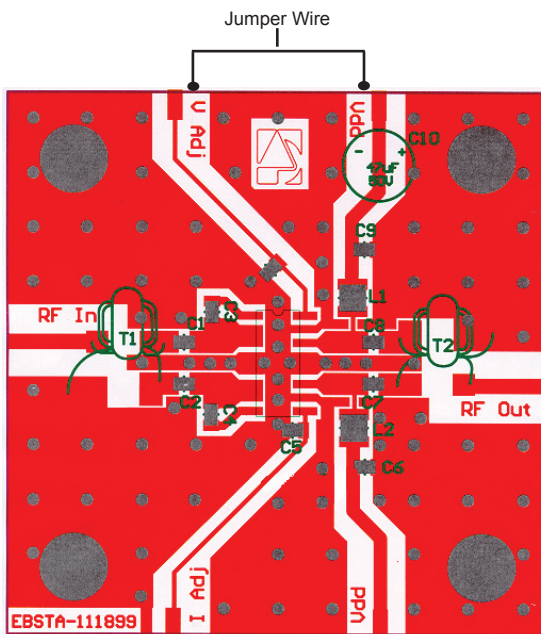

Figure 7: Evaluation Board Layout

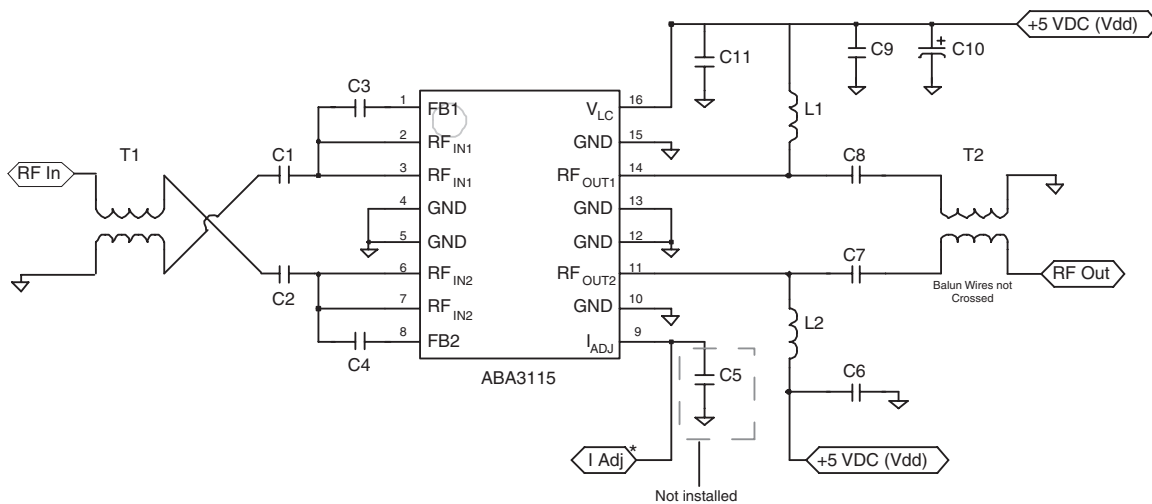

Figure 8: Evaluation Board Schematic

Note:

*Connecting a resistor from I_{ADJ} to ground lowers current; Normal operation is with I_{ADJ} floating.

Table 6: Evaluation Board Parts List

ITEM	DESCRIPTION	QTY	VENDOR	VENDOR PART NUMBER
C1-C4, C6, C9, C11	0.01uF CHIP CAP.	7	MURATA	GRM39X7R1103K25V
C7, C8	470 pF CHIP CAP.	2	MURATA	GRM39COG471J25V
C10	47 uF ELEC. CAP.	1	DIGI-KEY CORP	P5275-ND
C5	(not installed)			
L1, L2	390 nH CHIP INDUCTOR	2	COILCRAFT	1008CS-391XKBC
CONNECTORS ⁽¹⁾	75 Ω N MALE PANEL MOUNT	2	PASTERNAK ENTERPRISES	PE4504
T1, T2 ⁽²⁾ (BALUN)	Ferrite Core	2	FAIR-RITE	2843002702
	Wire		MWS WIRE IND.	T-2361429-20
	PCB	1	STAND. PRINTED CIRCUITS INC.	EBSTA-111899

Notes:

1. "N" Connector center pin should be approximately 80 mils in length.
2. Connector tabs must be reduced by 150 mils.
3. Device must be soldered on PC board.

NOTES:

1. MATERIAL:

CORE: FAIR-RITE (2843002702)
 WIRE: MWS WIRE IND.
 T-2361429-20
 5.5 TIMES THRU AS SHOWN.

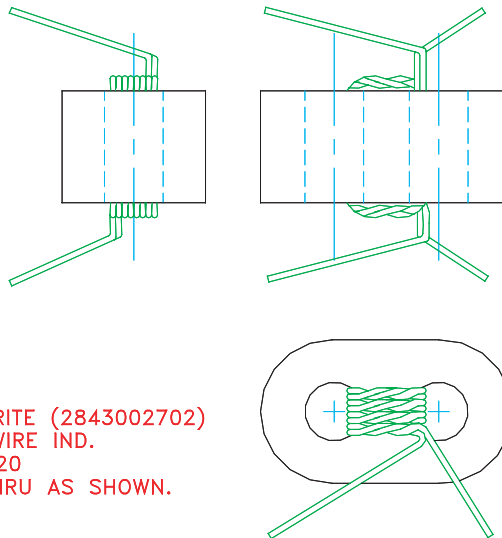
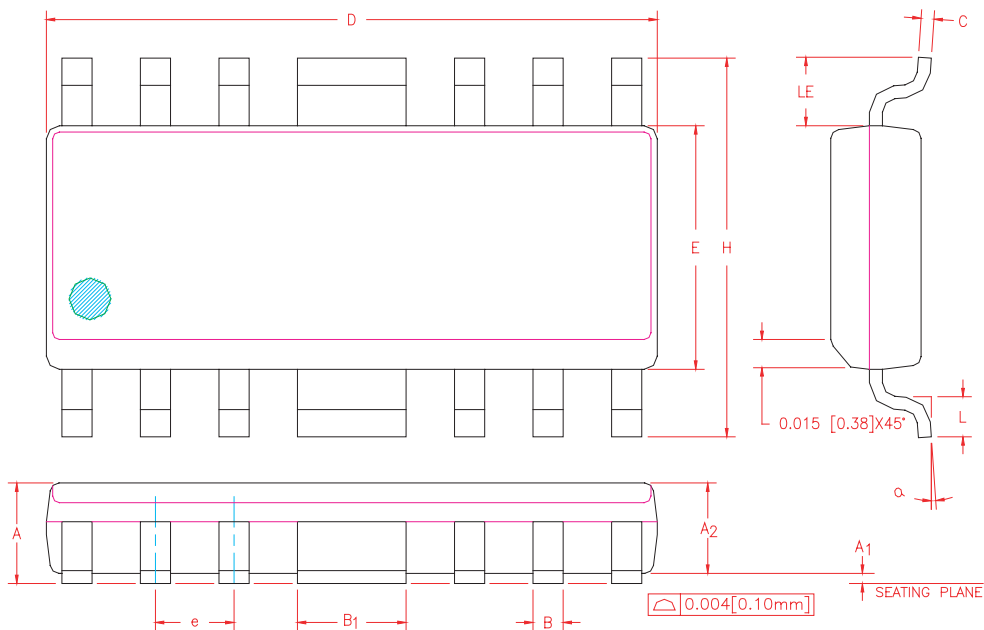

Figure 9: Balun Drawing

PACKAGE OUTLINE



SYMBOL	INCHES		MILLIMETERS		NOTE
	MIN.	MAX.	MIN.	MAX.	
A	0.058	0.068	1.47	1.73	
A1	0.004	0.010	0.10	0.25	
A2	0.054	0.065	1.37	1.65	
B	0.013	0.020	0.33	0.50	
B1	0.062	0.070	1.58	1.78	
C	0.008	0.010	0.20	0.25	4
D	0.380	0.400	9.66	10.16	2
E	0.150	0.160	3.81	4.06	3
e	0.050	BSC	1.27	BSC	
H	0.226	0.244	5.74	6.20	
L	0.016	0.040	0.41	1.02	
LE	0.030	—	0.76	—	
a	0°	8°	0°	8°	

NOTES:

1. CONTROLLING DIMENSION: INCHES
2. DIMENSION "D" DOES NOT INCLUDE MOLD FLASH, PROTRUSIONS OR GATE BURRS. MOLD FLASH, PROTRUSIONS AND GATE BURRS SHALL NOT EXCEED 0.006 [0.15mm] PER SIDE.
3. DIMENSION "E" DOES NOT INCLUDE INTER-LEAD FLASH OR PROTRUSIONS. INTER-LEAD FLASH AND PROTRUSIONS SHALL NOT EXCEED 0.010 [0.25mm] PER SIDE.
4. MAXIMUM LEAD TWIST/SKEW TO BE ± 0.005 [0.13mm].
5. LEAD THICKNESS AFTER PLATING TO BE 0.013 [0.33mm] MAXIMUM.

0-006

Figure 9: S3 Package Outline - Modified 16 Pin SOIC

ORDERING INFORMATION

ORDER NUMBER	TEMPERATURE RANGE	PACKAGE DESCRIPTION	COMPONENT PACKAGING
ABA3115RS3P1	-40 to +85 °C	RoHS-Compliant Modified 16 Pin SOIC	3,500 piece Tape and Reel
ABA3115RS3P0	-40 to +85 °C	RoHS-Compliant Modified 16 Pin SOIC	Plastic tubes (50 pieces per tube)



ANADIGICS, Inc.
 141 Mount Bethel Road
 Warren, New Jersey 07059, U.S.A
 Tel: +1 (908) 668-5000
 Fax: +1 (908) 668-5132
<http://www.anadigics.com>
Mktg@anadigics.com

IMPORTANT NOTICE

ANADIGICS, Inc. reserves the right to make changes to its products or to discontinue any product at any time without notice. The product specifications contained in Advanced Product Information sheets and Preliminary Data Sheets are subject to change prior to a product's formal introduction. Information in Data Sheets have been carefully checked and are assumed to be reliable; however, ANADIGICS assumes no responsibilities for inaccuracies. ANADIGICS strongly urges customers to verify that the information they are using is current before placing orders.

WARNING

ANADIGICS products are not intended for use in life support appliances, devices, or systems. Use of an ANADIGICS product in any such application without written consent is prohibited.