

### General Description

The MIC426/427/428 are dual high speed drivers. A TTL/CMOS input voltage level is translated into an output voltage level swing equal to the supply. The DMOS output will be within 25mV of ground or positive supply. Bipolar designs are capable of swinging only within 1 volt of the supply.

The low impedance high current driver outputs will swing a 1000pF load 18V in 30ns. The unique current and voltage drive qualities make the MIC426/427/428 ideal power MOSFET drivers, line drivers, and dc-to-dc converter building blocks.

Input logic signals may equal the power supply voltage. Input current is a low 1μA making direct interface to CMOS/bipolar switch-mode power supply control integrated circuits possible as well as open-collector analog comparators.

### Features

- High Speed Switching ( $C_L = 1000\text{pF}$ ) ..... 30ns
- High Peak Output Current ..... 1.5A
- High Output Voltage Swing .....  $V_S - 25\text{mV}$   
GND + 25mV
- Low Input Current (Logic "0" or "1") ..... 1μA
- Low Equivalent Input Capacitance (typ) ..... 6pF
- TTL/CMOS Input Compatible
- Available in Inverting & Non-Inverting Configurations
- Wide Operating Supply Voltage ..... 4.5V to 18V
- Low Power Consumption  
(Inputs Low) ..... 0.4mA  
(Inputs High) ..... 8mA
- Single Supply Operation
- Low Output Impedance (typ) ..... 6Ω
- Pin Out Equivalent to DS0026 & MMH0026

### Pin Configuration

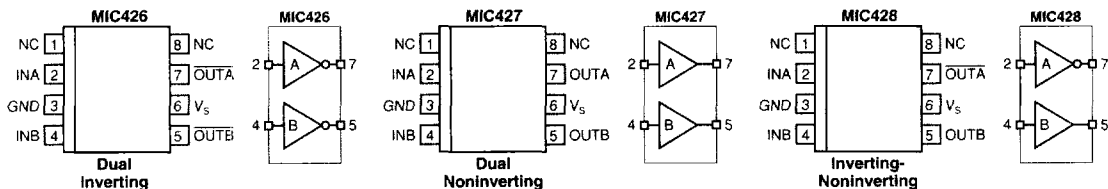

### Functional Diagram

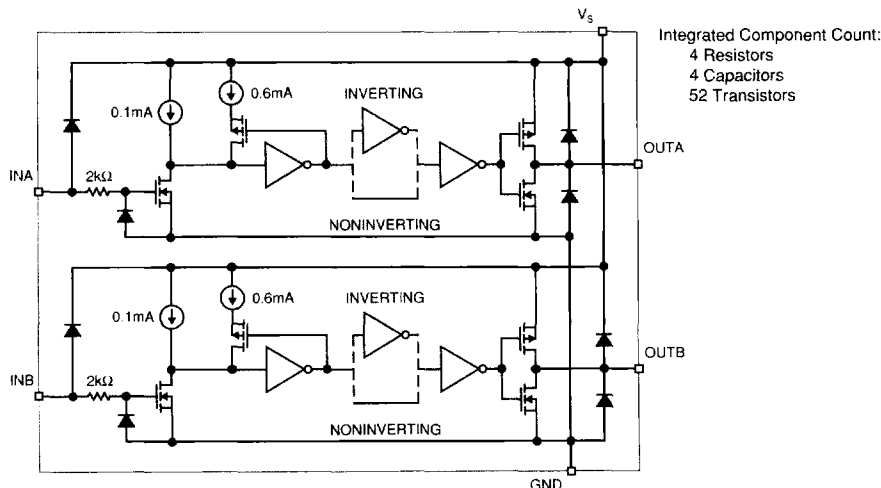

Ground Unused Inputs

Integrated Component Count:  
4 Resistors  
4 Capacitors  
52 Transistors

Quiescent power supply current is 8mA maximum. The MIC426 requires 1/5 the current of the pin compatible bipolar DS0026 device. This is important in dc-to-dc converter applications with power efficiency constraints and high frequency switch mode power supply applications. Quiescent current is typically

6mA when driving a 1000pF load 18V at 100kHz.

The inverting MIC426 driver is pin compatible with the bipolar DS0026 and MMH0026 devices. The MIC427 is non-inverting; the MIC428 contains an inverting and non-inverting driver.

### Ordering Information

Part Number	Temperature Range	Package	Configuration
MIC426CM MIC426BM	0°C to +70°C -40°C to +85°C	8-pin SOIC	Dual Inverting
MIC426CN MIC426BN	0°C to +70°C -40°C to +85°C	8-pin plastic DIP	Dual Inverting
MIC426AJ 5962-8850301PA <sup>1</sup>	-55°C to +125°C -55°C to +125°C	8-pin CerDIP	Dual Inverting
5962-8850302PA <sup>2</sup>	-55°C to +125°C	8-pin CerDIP	Dual Noninverting
5962-8850303PA <sup>3</sup>	-55°C to +125°C	8-pin CerDIP	Noninverting + Inverting

<sup>1</sup> Standard Military Drawing number for MIC426AJBQ

<sup>2</sup> Standard Military Drawing number for MIC427AJBQ

<sup>3</sup> Standard Military Drawing number for MIC428AJBQ

### Absolute Maximum Ratings (Notes 1, 2, and 3)

If Military/Aerospace specified devices are required, contact Micrel for availability and specifications.

Supply Voltage	20V
Input Voltage Any Terminal	$V_S + 0.3V$ to GND - 0.3V
Maximum Chip Temperature	150°C
Storage Temperature	-65°C to 150°C
Lead Temperature (10 sec)	300°C
Package Thermal Resistance	
CerDIP $R_{\theta J-A}$ (°C/W)	100
CerDIP $R_{\theta J-C}$ (°C/W)	50
PDIP $R_{\theta J-A}$ (°C/W)	130
PDIP $R_{\theta J-C}$ (°C/W)	42
SOIC $R_{\theta J-A}$ (°C/W)	120
SOIC $R_{\theta J-C}$ (°C/W)	75
Operating Temperature Range	
C Version	0°C to +70°C
B Version	-40°C to +85°C
A Version	-55°C to +125°C

**Electrical Characteristics:**  $T_A = 25^\circ\text{C}$  with  $4.5\text{V} \leq V_S \leq 18\text{V}$  unless otherwise specified.

No.	Symbol	Parameter	Conditions	Min	Typ	Max	Units
<b>INPUT</b>							
1	$V_{IH}$	Logic 1 Input Voltage		2.4	1.4		V
2	$V_{IL}$	Logic 0 Input Voltage			1.1	0.8	V
3	$I_{IN}$	Input Current	$0 \leq V_{IN} \leq V_S$	-1		1	$\mu\text{A}$
<b>OUTPUT</b>							
4	$V_{OH}$	High Output Voltage		$V_S - 0.025$			V
5	$V_{OL}$	Low Output Voltage				0.025	V
6	$R_O$	Output Resistance	$V_{IN} = 0.8\text{V}$ $I_{OUT} = 10\text{mA}$ , $V_S = 18\text{V}$		6	15	$\Omega$
7	$R_O$	Output Resistance	$V_{IN} = 2.4\text{V}$ $I_{OUT} = 10\text{mA}$ , $V_S = 18\text{V}$		6	10	$\Omega$
8	$I_{PK}$	Peak Output Current			1.5		A
<b>SWITCHING TIME</b>							
9	$T_R$	Rise Time	Test Figures 1, 2		18	30	ns
10	$T_F$	Fall Time	Test Figures 1, 2		15	20	ns
11	$T_{D1}$	Delay Time	Test Figures 1, 2		17	40	ns
12	$T_{D2}$	Delay Time	Test Figures 1, 2		23	75	ns
<b>POWER SUPPLY</b>							
13	$I_S$	Power Supply Current	$V_{IN} = 3.0\text{V}$ (Both Inputs)		1.4	8.0	mA
14	$I_S$	Power Supply Current	$V_{IN} = 0.0\text{V}$ (Both Inputs)		0.18	0.4	mA

**Electrical Characteristics:**Over operating temperature range with  $4.5\text{V} \leq V_S \leq 18\text{V}$  unless otherwise specified.

No.	Symbol	Parameter	Conditions	Min	Typ	Max	Units
<b>INPUT</b>							
1	$V_{IH}$	Logic 1 Input Voltage		2.4	1.5		V
2	$V_{IL}$	Logic 0 Input Voltage			1.0	0.8	V
3	$I_{IN}$	Input Current	$0 \leq V_{IN} \leq V_S$	-10		10	$\mu\text{A}$

**Electrical Characteristics:**Over operating temperature range with  $4.5V \leq V_S \leq 18V$  unless otherwise specified (Continued).

No.	Symbol	Parameter	Conditions	Min	Typ	Max	Units
<b>OUTPUT</b>							
4	$V_{OH}$	High Output Voltage		$V_S - 0.025$			V
5	$V_{OL}$	Low Output Voltage				0.025	V
6	$R_O$	Output Resistance	$V_{IN} = 0.8V$ $I_{OUT} = 10mA, V_S = 18V$		8	20	$\Omega$
7	$R_O$	Output Resistance	$V_{IN} = 2.4V$ $I_{OUT} = 10mA, V_S = 18V$		10	15	$\Omega$
<b>SWITCHING TIME</b>							
8	$T_R$	Rise Time	Test Figures 1, 2		20	60	ns
9	$T_F$	Fall Time	Test Figures 1, 2		29	40	ns
10	$T_{D1}$	Delay Time	Test Figures 1, 2		19	60	ns
11	$T_{D2}$	Delay Time	Test Figures 1, 2		27	120	ns
<b>POWER SUPPLY</b>							
12	$I_S$	Power Supply Current	$V_{IN} = 3.0V$ (Both Inputs)		1.5	12.0	mA
13	$I_S$	Power Supply Current	$V_{IN} = 0.0V$ (Both Inputs)		0.19	0.6	mA

**Note 1:** Functional operation above the absolute maximum stress ratings is not implied.**Note 2:** Static sensitive device (above 2kV). Unused devices must be stored in conductive material to protect devices from static discharge and static fields.**Note 3:** Switching times guaranteed by design.

Switching Time Test Circuits

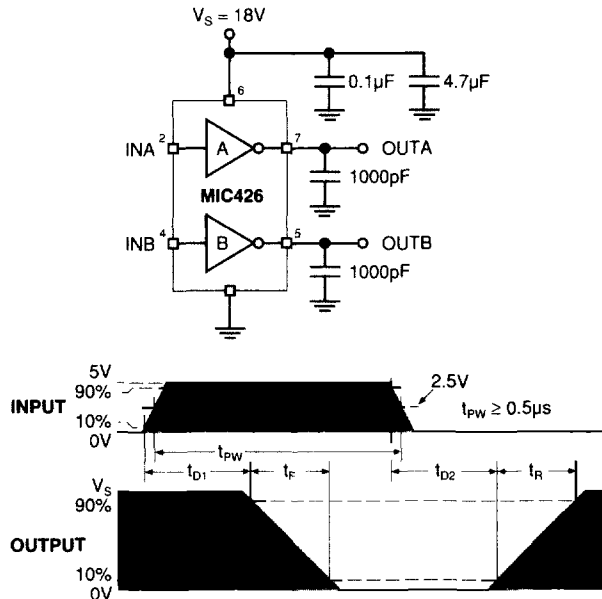

Figure 1. Inverting Driver Switching Time

5

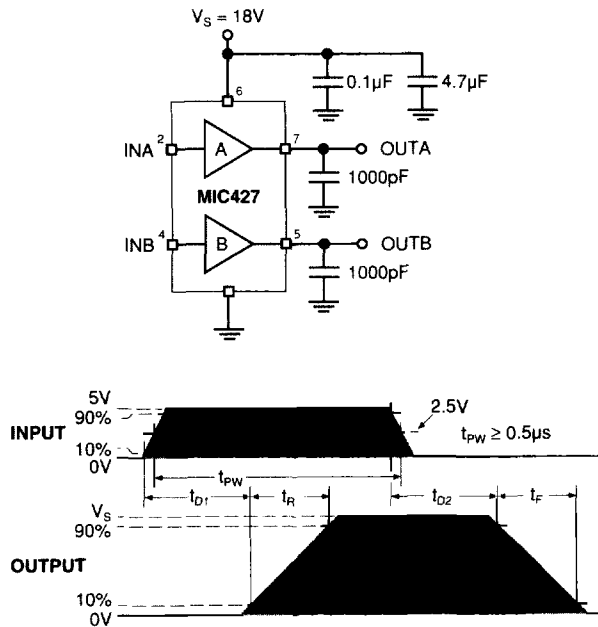
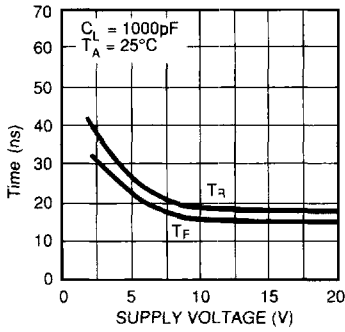

Figure 2. Noninverting Driver Switching Time

# Typical Characteristic Curves

**Rise and Fall Time vs. Supply Voltage**



**Delay Time vs. Supply Voltage**

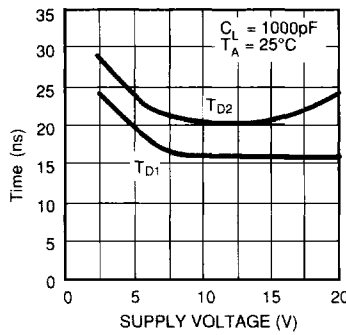

**Rise and Fall Time vs. Temperature**

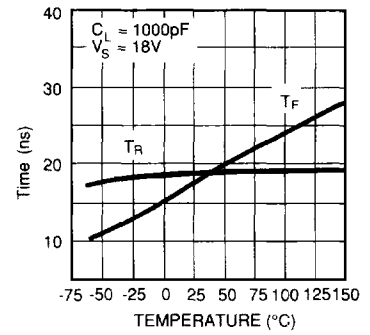

**Delay Time vs. Temperature**

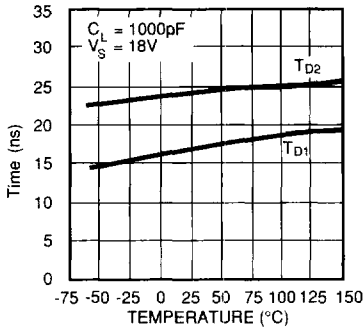

**Supply Current vs. Capacitive Load**

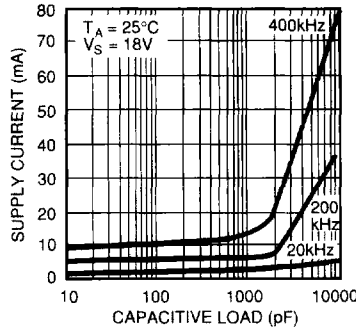

**Rise and Fall Time vs. Capacitive Load**

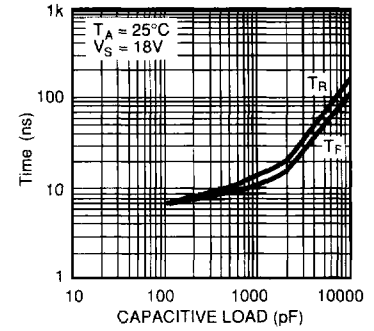

**Supply Current vs. Frequency**

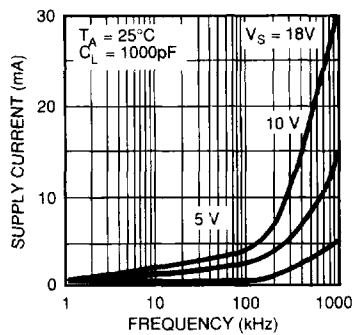

**High Output vs. Current**

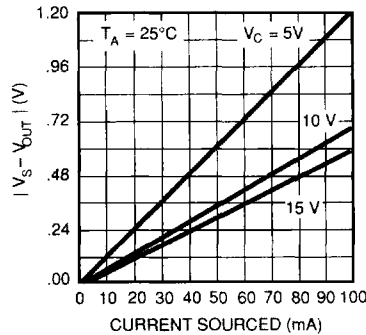

**Low Output vs. Current**

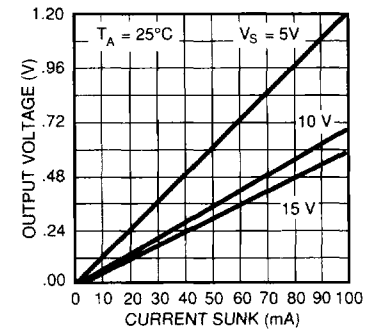

## Typical Characteristic Curves (Continued)

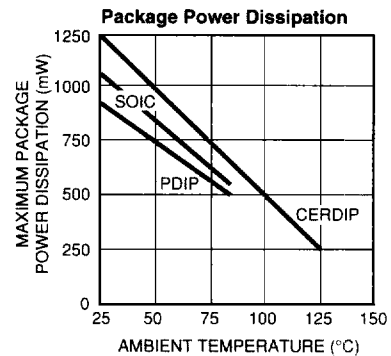
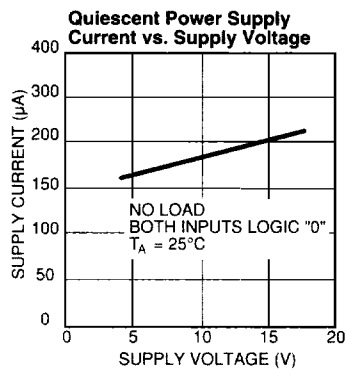
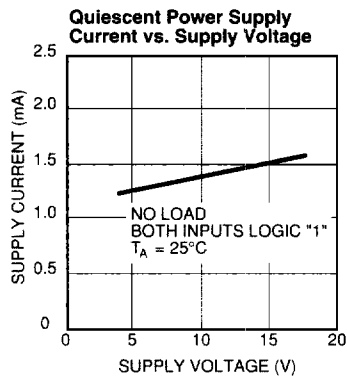

### Supply Bypassing

Charging and discharging large capacitive loads quickly requires large currents. For example, changing a 1000pF load 18 volts in 25ns requires a 0.8A current from the device power supply.

To guarantee low supply impedance over a wide frequency range, a parallel capacitor combination is recommended for supply bypassing. Low inductance ceramic disk capacitors with short lead lengths (< 0.5 inch) should be used. A 4.7µF solid tantalum capacitor in parallel with one or two 0.1µF ceramic disk capacitors normally provides adequate bypassing.

### Grounding

The MIC426 and MIC428 contain inverting drivers. Ground potential drops developed in common ground impedances from input to output will appear as negative feedback and degrade switching speed characteristics.

Individual ground returns for the input and output circuits or a ground plane should be used.

### Input Stage

The input voltage level changes the no load or quiescent supply current. The N channel MOSFET input stage transistor drives a 2.5mA current source load. With a logic "1" input, the maximum quiescent supply current is 8mA. Logic "0" input level signals reduce quiescent current to 400µA maximum. Minimum power dissipation occurs for logic "0" inputs for the MIC426/427/428; unused driver inputs **must be grounded or tied to the positive supply**.

The drivers are designed with 100mV of hysteresis. This provides clean transitions and minimizes output stage current spiking when changing states. Input voltage thresholds are approximately 1.5V making the device TTL compatible over the 4.5V to 18V operating supply range. Input current is less than 1µA over this range.

The MIC426/427/428 may be directly driven by the TL494, SG1526/1527, SG1524, SE5560 and similar switch-mode power supply integrated circuits.

### Power Dissipation

The supply current vs. frequency and supply current vs. capacitive load characteristic curves will aid in performing power dissipation calculations.

The MIC426 CMOS drivers have greatly reduced quiescent dc power consumption. Maximum quiescent current is 8mA compared to the DS0026 40mA specification. For a 15V supply, power dissipation is typically 40mW.

Two other power dissipation components are:

- Output stage ac and dc load power.
- Transition state power.

Output stage power is:

$$P_O = P_{DC} + P_{AC} \\ = V_O (I_{DC}) + f C_L V_S^2$$

Where:  $V_O$  = dc output voltage  
 $I_{DC}$  = dc output load current  
 $f$  = Switching frequency  
 $V_S$  = Supply voltage

In power MOSFET drive applications, the  $P_{DC}$  term is negligible. MOSFET power transistors are high impedance, capacitive input devices. In applications where resistive loads or relays are driven, the  $P_{DC}$  component will normally dominate.

The magnitude of  $P_{AC}$  is readily estimated for several cases:

- |                           |                           |
|---------------------------|---------------------------|
| A. 1. $f = 200\text{kHz}$ | B. 1. $f = 200\text{kHz}$ |
| 2. $C_L = 1000\text{pF}$  | 2. $C_L = 1000\text{pF}$  |
| 3. $V_S = 18\text{V}$     | 3. $V_S = 15\text{V}$     |
| 4. $P_{AC} = 65\text{mW}$ | 4. $P_{AC} = 45\text{mW}$ |

During output level state changes, a current surge will flow through the series connected N- and P- channel output MOSFETs as one device is turning "ON" while the other is

turning "OFF." The current spike flows only during output transitions. The input levels should not be maintained between the logic "0" and logic "1" levels. **Unused driver inputs must be tied to ground and not be allowed to float.** Average

power dissipation will be reduced by minimizing input rise times. As shown in the characteristic curves, average supply current is frequency dependent.

### Voltage Doubler

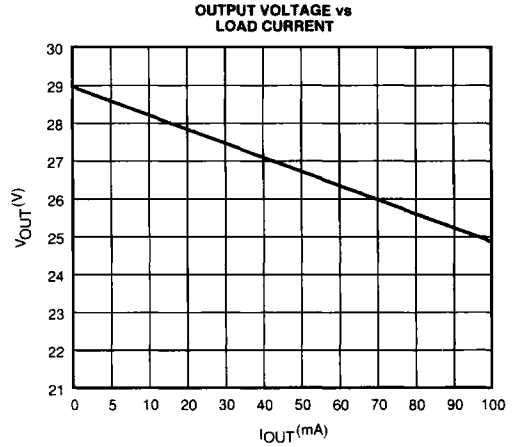
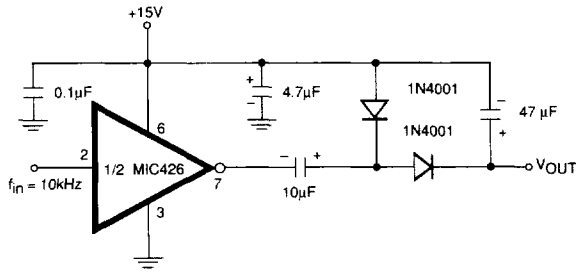

### Voltage Inverter

