

Gallium Nitride 28V, 23W RF Power Transistor

Built using the SIGANTIC[®] NRF1 process - A proprietary GaN-on-Silicon technology

FEATURES

- Optimized for CW, pulsed, WiMAX, and other applications from DC - 3000 MHz
- 23W P_{3dB} peak envelope power (PEP)
- 1.5W linear power @ 2% EVM for single carrier OFDM, 10.3dB peak/average, 3.5MHz channel bandwidth, 14dB gain, 23.5% efficiency, 2500-2700MHz
- 100% RF tested
- Thermally-enhanced industry standard package
- High reliability gold metallization process
- Lead-free and RoHS compliant
- Subject to EAR99 export control

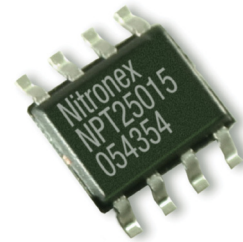

**DC - 3000 MHz
23 Watt, 28 Volt
GaN HEMT**



Typical 2-Tone Performance: V_{DS} = 28V, I_{DQ} = 200mA, Frequency = 2500MHz, Tone Spacing = 1.0MHz, T_C = 25°C
Measured in Nitronex Test Fixture

Symbol	Parameter	Min	Typ	Max	Units
P _{3dB,PEP}	Peak Envelope Power at 3dB Compression	20	25	-	W
P _{1dB,PEP}	Peak Envelope Power at 1dB Compression	-	15	-	W
G _{SS}	Small Signal Gain	13.0	14.0	15.0	dB
η	Drain Efficiency at 3dB Compression	53	58	-	%

Typical OFDM Performance: V_{DS} = 28V, I_{DQ} = 200mA, Single carrier OFDM waveform 64-QAM 3/4, 8 burst, continuous frame data, 10 MHz channel bandwidth. Peak/Avg = 10.3dB @ 0.01% probability on CCDF. Frequency = 2500 - 2700MHz. P_{OUT,AVG} = 1.5W, T_C = 25°C. Measured in Load Pull System (Refer to Table 1 and Figure 1)

Symbol	Parameter	Typ	Units
G _p	Power Gain	14.0	dB
η	Drain Efficiency	23.5	%
EVM	Error Vector Magnitude	2.0	%

NPT25015



DC Specifications: $T_C = 25^\circ\text{C}$

Symbol	Parameter	Min	Typ	Max	Units
Off Characteristics					
V_{BDS}	Drain-Source Breakdown Voltage ($V_{GS} = -8\text{V}$, $I_D = 8\text{mA}$)	100	-	-	V
I_{DLK}	Drain-Source Leakage Current ($V_{GS} = -8\text{V}$, $V_{DS} = 60\text{V}$)	-	-	4	mA
On Characteristics					
V_T	Gate Threshold Voltage ($V_{DS} = 28\text{V}$, $I_D = 8\text{mA}$)	-2.3	-1.8	-1.3	V
V_{GSQ}	Gate Quiescent Voltage ($V_{DS} = 28\text{V}$, $I_D = 200\text{mA}$)	-2.0	-1.5	-1.0	V
R_{ON}	On Resistance ($V_{GS} = 2\text{V}$, $I_D = 60\text{mA}$)	-	0.45	0.50	Ω
$I_{D,MAX}$	Drain Current ($V_{DS} = 7\text{V}$ pulsed, 300ms pulse width, 0.2% duty cycle)	-	5.0	-	A

Absolute Maximum Ratings: Not simultaneous, $T_C = 25^\circ\text{C}$ unless otherwise noted

Symbol	Parameter	Max	Units
V_{DS}	Drain-Source Voltage	100	V
V_{GS}	Gate-Source Voltage	-10 to 3	V
P_T	Total Device Power Dissipation (Derated above 25°C)	28	W
θ_{JC}	Thermal Resistance (Junction-to-Case)	6.25	$^\circ\text{C}/\text{W}$
T_{STG}	Storage Temperature Range	-65 to 150	$^\circ\text{C}$
T_J	Operating Junction Temperature	200	$^\circ\text{C}$
HBM	Human Body Model ESD Rating (per JESD22-A114)	1A (>250V)	
MM	Machine Model ESD Rating (per JESD22-A115)	M1 (>50V)	
MSL	Moisture Sensitivity Level (Per IPC/JEDEC J-STD-20) @ 260°C Peak Package Temperature	3	

Load-Pull Data, Reference Plane at Device Leads

$V_{DS}=28V$, $I_{DQ}=200mA$, $T_A=25^\circ C$ unless otherwise noted

Table 1: Optimum Impedance Characteristics for Linear OFDM Tuning, single carrier OFDM waveform 64-QAM 3/4, 8 burst, continuous frame data, 10 MHz channel bandwidth. Peak/Avg = 10.3dB @ 0.01% probability on CCDF

Frequency (MHz)	$Z_S (\Omega)$	$Z_L (\Omega)$	$P_{OUT} (W)$	Gain (dB)	Drain Efficiency (%)
2500	5.2 - j 1.6	3.3 + j 1.7	1.5	14.5	25
2600	4.6 - j 1.9	3.1 + j 2.7	1.5	14.5	25
2700	4.0 - j 2.2	2.9 + j 4.3	1.5	14.4	24

Table 2: Optimum Impedance Characteristics for CW P_{SAT} , Efficiency, and Gain

Frequency (MHz)	$Z_S (\Omega)$	$Z_L (\Omega)$	$P_{SAT} (W)$	$G_{SS} (dB)$	Drain Efficiency (%)
2500	3.7 - j 4.7	6.9 - j 1.2	23	14.5	60

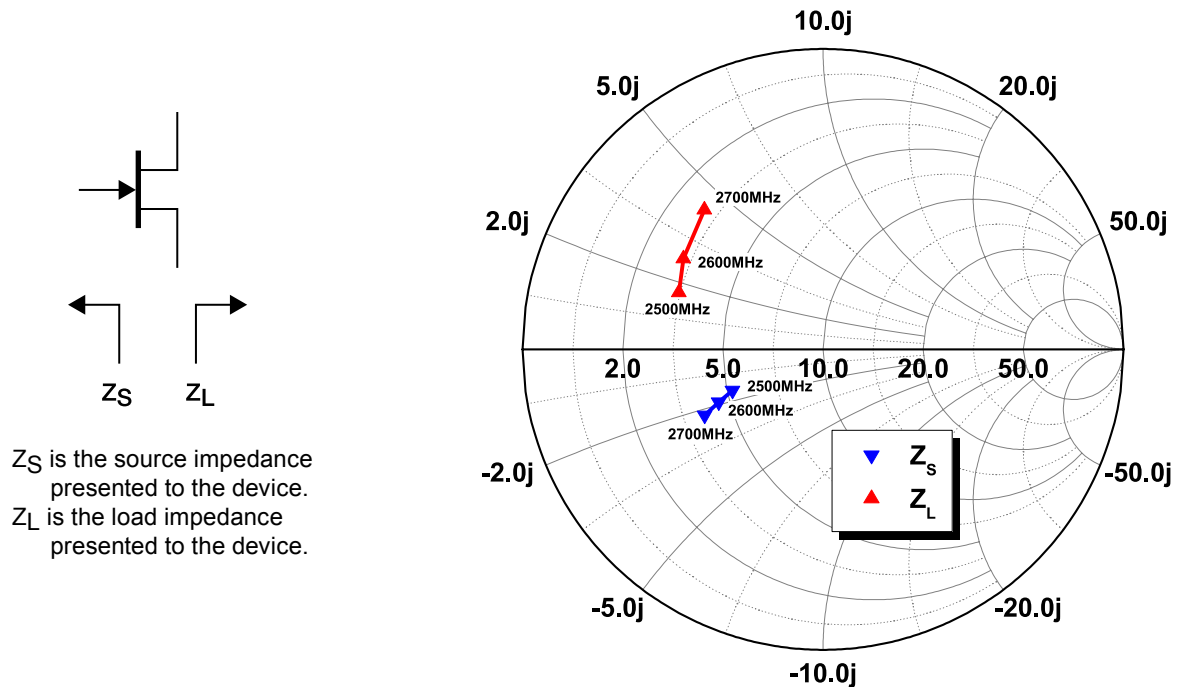

Figure 1 - Optimum Impedance Characteristics for OFDM Tuning, $V_{DS} = 28V$, $I_{DQ} = 200mA$

Load-Pull Data, Reference Plane at Device Leads

$V_{DS}=28V$, $I_{DQ}=200mA$, $T_A=25^\circ C$ unless otherwise noted

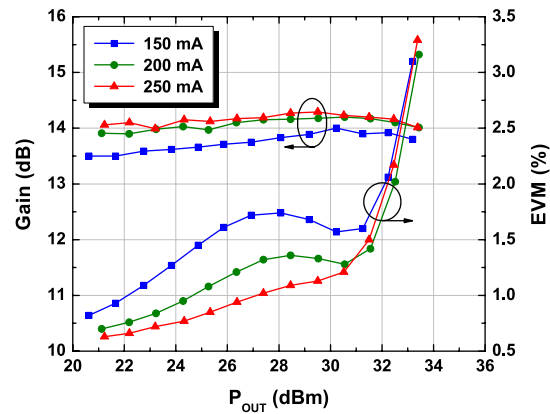

Figure 2 - Typical OFDM Performance at 2500MHz and 28V versus I_{DQ}

Typical Device Characteristics

$V_{DS}=28V$, $I_{DQ}=200mA$, $T_A=25^\circ C$ unless otherwise noted

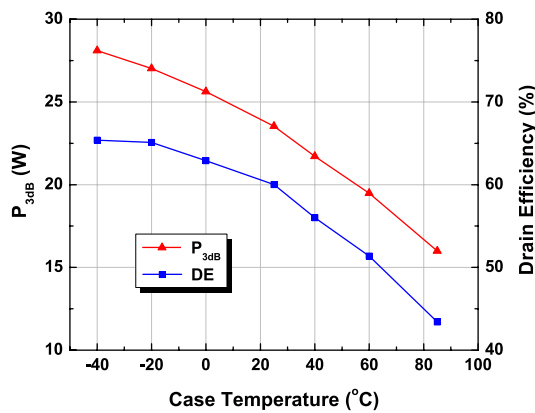

Figure 3 - $P_{3dB,PEP}$ and Drain Efficiency versus Temperature at 2500MHz, Application Board

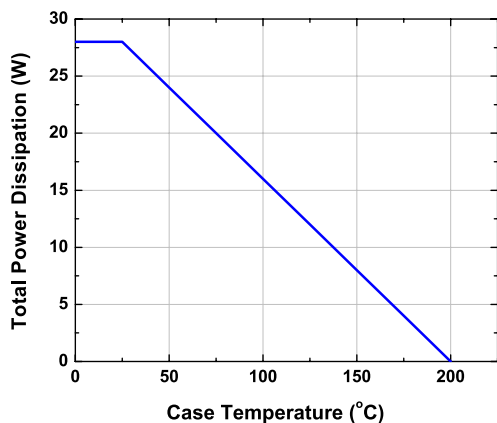

Figure 4 - Power Derating Curve

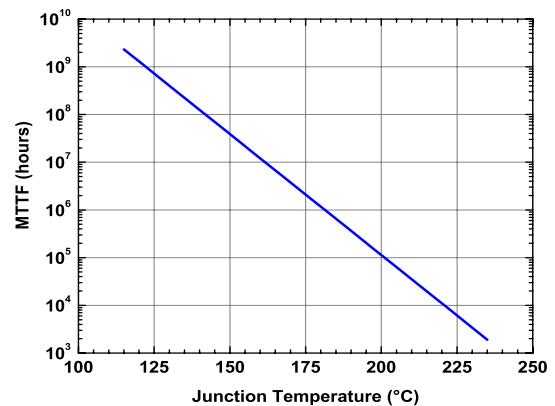

Figure 5 - MTTF of NRF1 devices as a function of junction temperature

APP-NPT25015-25, 2500-2700MHz Linear WiMAX Application Board

802.16e Single Carrier OFDM, 64-QAM 3/4, 8-burst, 20ms frame 75% filled, 10MHz channel bandwidth, PAR=10.3dB @ 0.01% CCDF
 Detailed design information and data available at www.nitronex.com

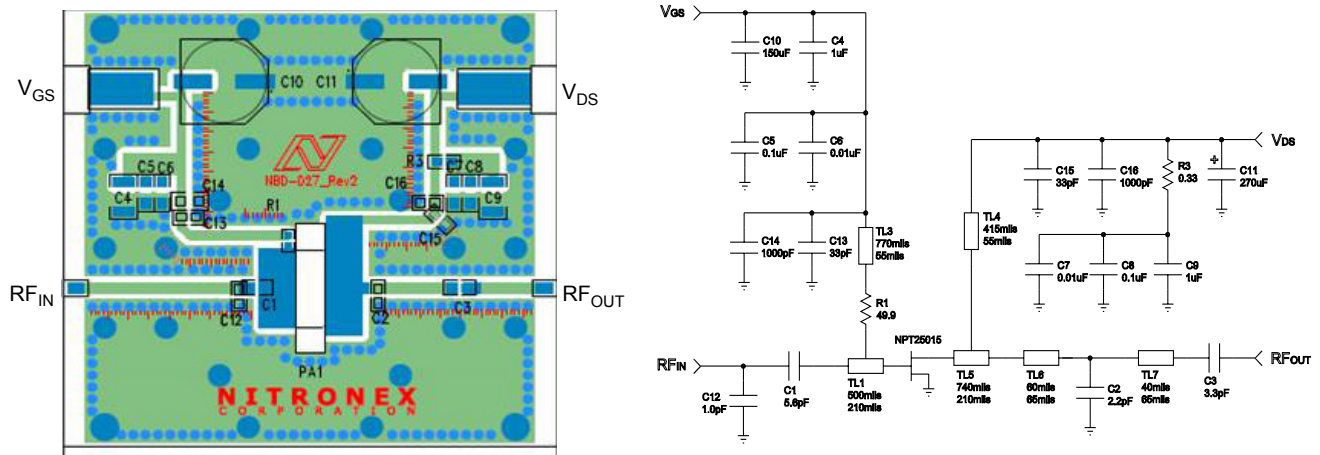

Figure 6 - APP-NPT25015-25 Demonstration Board and Schematic

Table 2: APP-NPT25015-25 Demonstration Board Bill of Materials

Name	Value	Tolerance	Vendor	Vendor Number
C1	5.6pF	+/- 0.1pF	ATC	ATC600F5R6B
C2	2.2pF	+/- 0.1pF	ATC	ATC600F2R2B
C3	3.3pF	+/- 0.1pF	ATC	ATC600F3R3B
C4, C9	1.0uF	10%	Panasonic	ECJ-5YB2A105M
C5, C8	0.1uF	10%	Kemet	C1206C104K1RACTU
C6, C7	0.01uF	10%	AVX	12061C103KAT2A
C10	150uF	20%	Nichicon	UPW1C151MED
C11	270uF	20%	United Chemi-Con	ELXY630ELL271MK25S
C12	1.0pF	+/- 0.1pF	ATC	ATC600F1R0B
C13, C15	33pF	5%	ATC	ATC600F330B
C14, C16	1000pF	10%	Kemet	C0805C102K1RACTU
PA1	--	--	--	NPT25015D
R1	49.9 ohm	1%	Panasonic	ERJ-2RKF49R9X
R3	0.33 ohm	1%	Panasonic	ERJ-6RQFR33V
--	--	--	--	Coin to mount PA1
Substrate			Rogers	R04350, t = 30mil $\epsilon_r = 3.5$

APP-NPT25015-25, 2500-2700MHz Linear WiMAX Application Board

802.16e Single Carrier OFDM, 64-QAM 3/4, 8-burst, continuous frame data, 10MHz channel bandwidth, PAR=10.3dB @ 0.01% CCDF
 Detailed design information and data available at www.nitronex.com

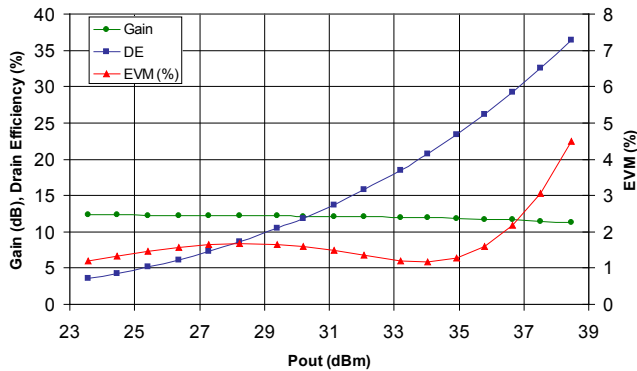

Figure 7 - Gain, Efficiency, EVM at 2500MHz

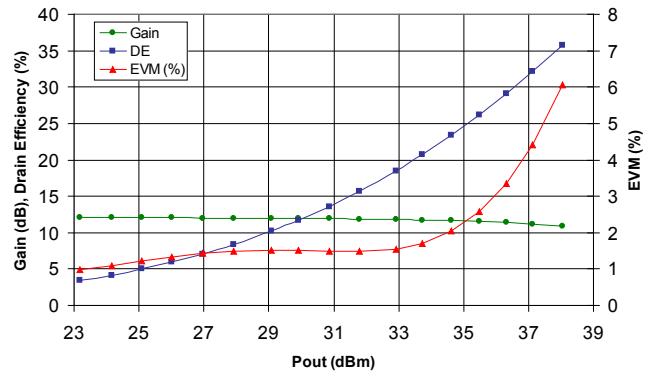

Figure 8 - Gain, Efficiency, EVM at 2600MHz

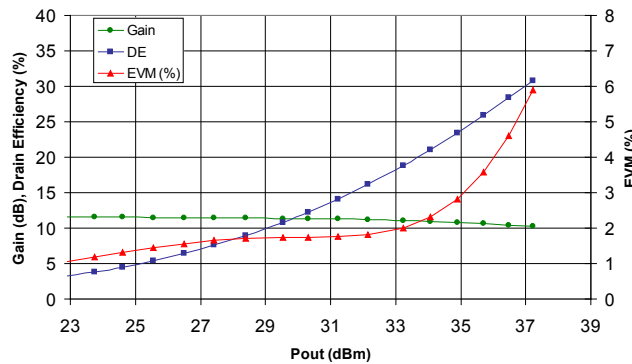

Figure 9 - Gain, Efficiency, EVM at 2700MHz

NPT25015



Ordering Information

Part Number	Order Multiple	Description
NPT25015DT	97	Tube; NPT25015 in D (PSOP2) Package
NPT25015DR	1500	Tape and Reel; NPT25015 in D (PSOP2) Package

1: To find a Nitronex contact in your area, visit our website at <http://www.nitronex.com>

Figure 10 - D Package Dimensions and Pinout

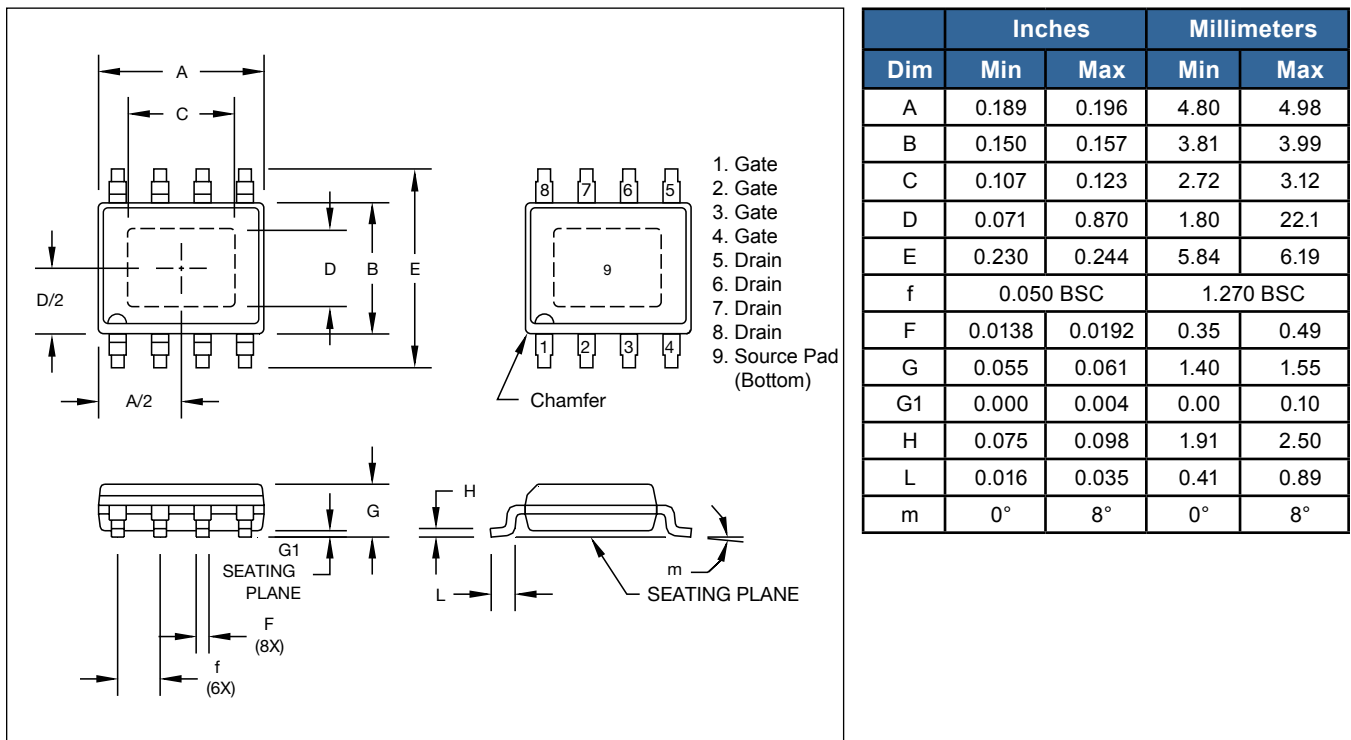
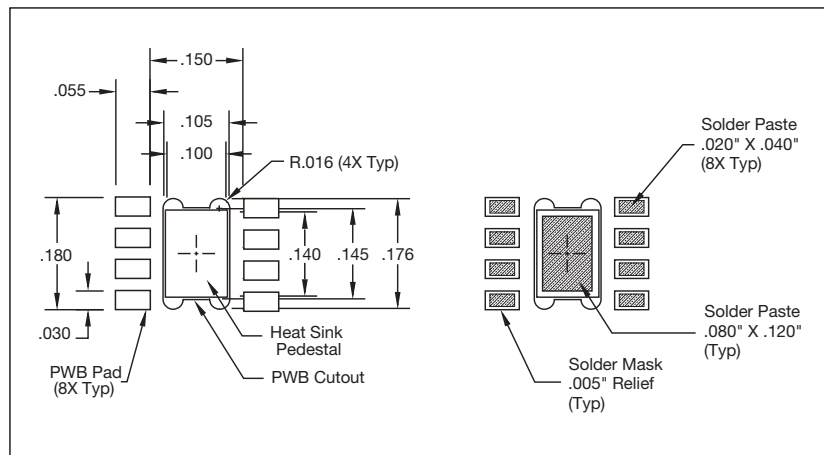

Figure 11 - Mounting Footprint



Nitronex, LLC

2305 Presidential Drive
Durham, NC 27703 USA
+1.919.807.9100 (telephone)
+1.919.807.9200 (fax)
info@nitronex.com
www.nitronex.com

Additional Information

This part is lead-free and is compliant with the RoHS directive (Restrictions on the Use of Certain Hazardous Substances in Electrical and Electronic Equipment).

Important Notice

Nitronex, LLC reserves the right to make corrections, modifications, enhancements, improvements and other changes to its products and services at any time and to discontinue any product or service without notice. Customers should obtain the latest relevant information before placing orders and should verify that such information is current and complete. All products are sold subject to Nitronex terms and conditions of sale supplied at the time of order acknowledgment. The latest information from Nitronex can be found either by calling Nitronex at 1-919-807-9100 or visiting our website at www.nitronex.com.

Nitronex warrants performance of its packaged semiconductor or die to the specifications applicable at the time of sale in accordance with Nitronex standard warranty. Testing and other quality control techniques are used to the extent Nitronex deems necessary to support the warranty. Except where mandated by government requirements, testing of all parameters of each product is not necessarily performed.

Nitronex assumes no liability for applications assistance or customer product design. Customers are responsible for their product and applications using Nitronex semiconductor products or services. To minimize the risks associated with customer products and applications, customers should provide adequate design and operating safeguards.

Nitronex does not warrant or represent that any license, either express or implied, is granted under any Nitronex patent right, copyright, mask work right, or other Nitronex intellectual property right relating to any combination, machine or process in which Nitronex products or services are used.

Reproduction of information in Nitronex data sheets is permitted if and only if said reproduction does not alter any of the information and is accompanied by all associated warranties, conditions, limitations and notices. Any alteration of the contained information invalidates all warranties and Nitronex is not responsible or liable for any such statements.

Nitronex products are not intended or authorized for use in life support systems, including but not limited to surgical implants into the body or any other application intended to support or sustain life. Should Buyer purchase or use Nitronex, LLC products for any such unintended or unauthorized application, Buyer shall indemnify and hold Nitronex, LLC, its officers, employees, subsidiaries, affiliates, distributors, and its successors harmless against all claims, costs, damages, and expenses, and reasonable attorney fees arising out of, directly or indirectly, any claim of personal injury or death associated with such unintended or unauthorized use, notwithstanding if such claim alleges that Nitronex was negligent regarding the design or manufacture of said products.

Nitronex and the Nitronex logo are registered trademarks of Nitronex, LLC.
All other product or service names are the property of their respective owners.
©Nitronex, LLC 2012. All rights reserved.