

REV.	REVISION	DATE	DRAWN	CHECKED	APPROVED
0	NEW DRAW	04.04.07	J.H.LEE		
1	Δ 1.35 ± 0.15 → 0.95 ± 0.15	04.04.09	J.H.LEE		
2	Δ 0.95 ± 0.15 → 0.95 ± 0.1	04.04.12	J.H.LEE		

REMARK

1. Glass Thk: 0.7mm
2. Film Type: Non_Glare
3. Total Thk: 0.95 ± 0.15
4. Linearity: ± 1.5 or less
5. Transmittance: 80% or more
6. Resistance
- 200 < Glass(X) < 900 ohm
- 200 < Film(Y) < 900 ohm
7. Connector: FPC

CIRCUIT DIAGRAM

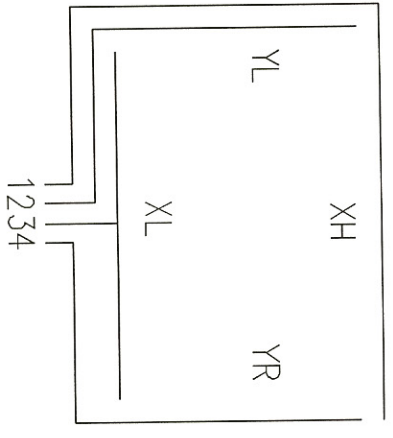

SIGNAL ASSIGNMENT

Pin No	Signal
1	XH
2	YL
3	XL
4	YR

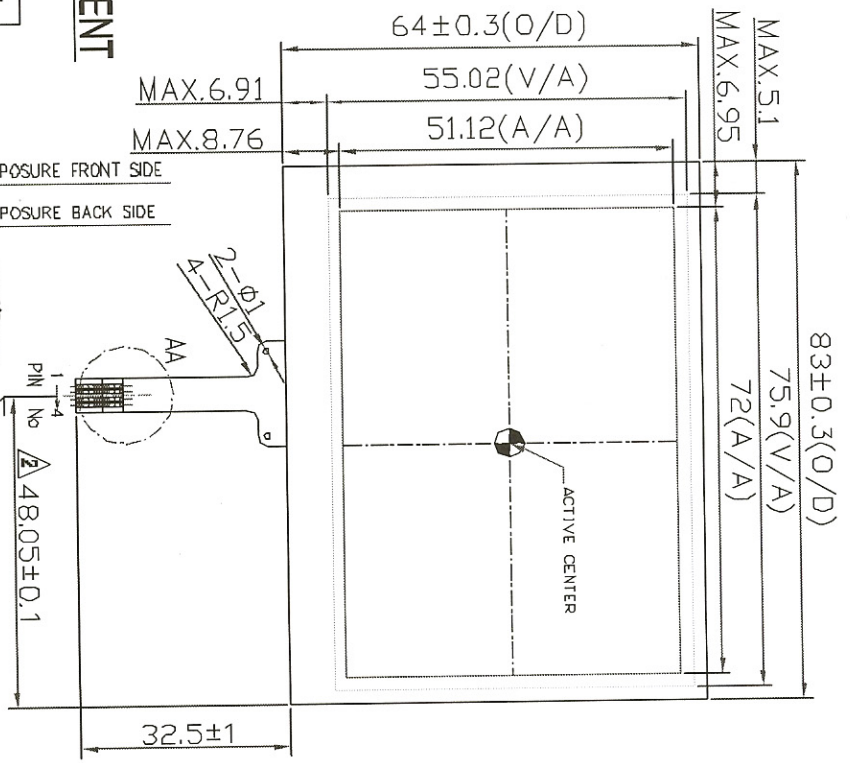

Detail "AA" (Scale=4/1)

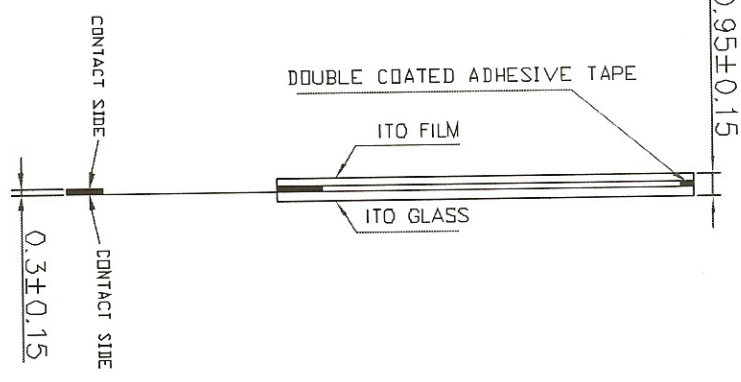

APPROVE	CHECK	DESIGN	DRAW	UNIT	SCALE	NO.	INDICATE	DRAWING NO.	DESCRIPTION	REV.
								HT-035ABK-00	3.5 TOUCH PANEL	1/1