

Fast Ultra High-PSRR, Low-Noise, 300mA CMOS Linear Regulator

General Description

The EMP8734 features ultra-high power supply rejection ratio, low output voltage noise, low dropout voltage, low quiescent current and fast transient response. It guarantees delivery of 300mA output current and supports preset output voltages ranging from 0.8V to 4.5V with 0.05V increment.

Based on its low quiescent current consumption and its less than 1 μ A shutdown mode of logical operation, the EMP8734 is ideal for battery-powered applications. The high power supply rejection ratio of the EMP8734 holds well for low input voltages typically encountered in battery-operated systems. The regulator is stable with small ceramic capacitive loads (1 μ F typical). The EMP8734 is Available in miniature SOT-23-5 SOT-353(SC-70-5), SOT-343 and TDFN-6 packages.

- 300mA guaranteed output current
- 62dB typical PSRR at 1kHz
- 110 μ V RMS output voltage noise (10Hz to 100kHz)
- 290mV typical dropout at 300mA
- 57 μ A typical quiescent current
- Less than 1 μ A typical shutdown mode
- Fast line and load transient response
- 2.2V to 5.5V input range
- Auto-discharge during chip disable
- 80 μ s typical turn-on time
- Stable with small ceramic output capacitors
- Over temperature and over current protection
- \pm 2% output voltage tolerance

Applications

- Wireless handsets
- PCMCIA cards
- DSP core power
- Hand-held instruments
- Battery-powered systems
- Portable information appliances

Features

Typical Application

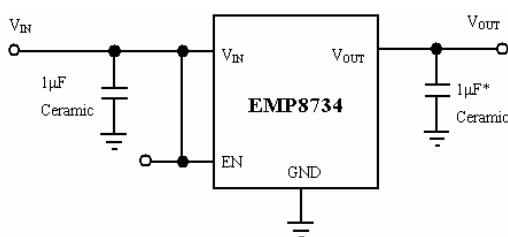

*Use 2.2 μ F for $V_{OUT} < 1.2V$

CONNECTION DIAGRAM SOT-23-5(TOP View)

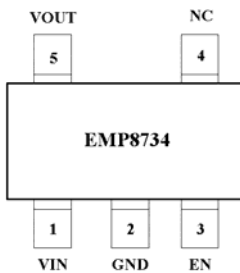

ORDER INFORMATION

EMP8734-XXVF05GRR

XX Output voltage
 VF05 SOT-23-5 Package
 GRR RoHS & Halogen free
 Rating: -40 to 85°C
 Package in Tape & Reel

TDFN-6(TOP View)

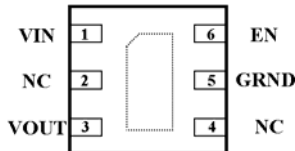

EMP8734-XXFE06NRR

XX Output voltage
 FE06 TDFN-6 Package
 NRR RoHS & Halogen free
 Rating: -40 to 85°C
 Package in Tape & Reel

SOT-353 (SC-70-5) (TOP View)

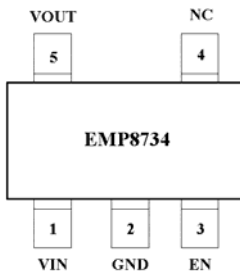

EMP8734-XXVI05NRR

XX Output voltage
 VI05 SOT-353 Package
 NRR RoHS & Halogen free
 Rating: -40 to 85°C
 Package in Tape & Reel

SOT-343 (SC-82-4) (TOP View)

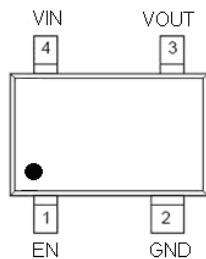

EMP8734-XXVJ04NRR

XX Output voltage
 VJ04 SOT-343 Package
 NRR RoHS & Halogen free
 Rating: -40 to 85°C
 Package in Tape & Reel

Pin Functions

Name	SOT-23-5	TDFN-6	SOT-353	Function
VIN	1	1	1	Supply Voltage Input. Require a minimum input capacitor of close to 1μF to ensure stability and sufficient decoupling from the ground pin.
GND	2	5	2	Ground Pin.
EN	3	6	3	Enable Input. Enable the regulator by pulling the EN pin High. To keep the regulator on during normal operation, connect the EN pin to VIN. The EN pin must not exceed VIN under all operating conditions.
NC	4	2/4	4	No Connection
VOUT	5	3	5	Output Voltage Feedback.

Order, Mark & Packing Information

Marking	Vout	Product ID	Packing
<p>8734 Tracking Code PIN1 DOT</p>	1.2	EMP8734-12VF05GRR	3K units Tape & Reel
	1.5	EMP8734-15VF05GRR	3K units Tape & Reel
	1.8	EMP8734-18VF05GRR	3K units Tape & Reel
	2.5	EMP8734-25VF05GRR	3K units Tape & Reel
	2.8	EMP8734-28VF05GRR	3K units Tape & Reel
	3.0	EMP8734-30VF05GRR	3K units Tape & Reel
	3.3	EMP8734-33VF05GRR	3K units Tape & Reel
<p>8734 Tracking Code PIN1 DOT</p>	2.5	EMP8734-25FE06NRR	5K units Tape & Reel
<p>8734 Tracking Code PIN1 DOT</p>	1.2	EMP8734-12VI05NRR	3K units Tape & Reel
	1.3	EMP8734-13VI05NRR	3K units Tape & Reel
	1.8	EMP8734-18VI05NRR	3K units Tape & Reel
	2.5	EMP8734-25VI05NRR	3K units Tape & Reel
	3.3	EMP8734-33VI05NRR	3K units Tape & Reel

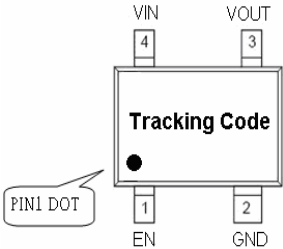
Marking	Vout	Product ID	Packing
	1.2	EMP8734-12VJ04NRR	3K units Tape & Reel
	1.8	EMP8734-18VJ04NRR	
	2.8	EMP8734-28VJ04NRR	
	3.3	EMP8734-33VJ04NRR	

Absolute Maximum Ratings (Notes 1, 2)

V _{IN} , V _{OUT} , V _{EN}	-0.3V to 6.5V	Thermal Resistance (θ _{JA})	
Storage Temperature Range	-65°C to 160°C	SOT-23-5	250°C/W
Junction Temperature (T _J)	150°C	SOT-343/SOT-353	(Note 6)
Lead Temperature (10 sec.)	240°C	TDFN-6	(Note 6)
ESD Rating		Operating Ratings (Note 1, 2)	
Human Body Model	2kV	Temperature Range	-40°C to 85°C
MM	200V	Supply Voltage	2.2V to 5.5V

Electrical Characteristics

Unless otherwise specified, all limits guaranteed for V_{IN} = V_{OUT} + 1V (Note 3), V_{EN} = V_{IN}, C_{IN} = C_{OUT} = 2.2μF, T_A = 25°C.

Boldface limits apply for the operating temperature extremes: -40°C and 85°C.

Symbol	Parameter	Conditions	Min	Typ	Max	Units
V _{IN}	Input Voltage		2.2		5.5	V
V _{OUT}	Output Voltage		0.8		4.5	V
ΔV _{OTL}	Output Voltage Tolerance	1mA ≤ I _{OUT} ≤ 300mA	-2		+2	% of V _{OUT (NOM)}
		V _{OUT (NOM)} + 1V ≤ V _{IN} ≤ 5.5V (Note 3)	-3		+3	
I _{OUT}	Maximum Output Current	Average DC Current Rating	300			mA
I _{LIMIT}	Output Current Limit		300	450		mA
I _Q	Supply Current	I _{OUT} = 0mA		57		μA
		I _{OUT} = 300mA		130		
	Shutdown Supply Current	V _{OUT} = 0V, EN = GND		0.001	1	
V _{DO}	Dropout Voltage (Note 4)	I _{OUT} = 100mA		90		mV
		I _{OUT} = 300mA		290		
ΔV _{OUT}	Line Regulation	I _{OUT} = 1mA, (V _{OUT} + 1V) ≤ V _{IN} ≤ 5.5V (Note 3)	-0.1	0.01	0.1	%/V
	Load Regulation	1mA ≤ I _{OUT} ≤ 300mA		0.0008		%/mA
e _n	Output Voltage Noise	V _{OUT} = 2.5V, I _{OUT} = 10mA, 10Hz ≤ f ≤ 100kHz		110		μV _{RMS}
T _{SD}	Thermal Shutdown Temperature			165		°C
	Thermal Shutdown Hysteresis			35		
V _{EN}	EN Input Threshold	V _{IH} , (V _{OUT} + 1V) ≤ V _{IN} ≤ 5.5V (Note 3)	1.2			V
		V _{IL} , (V _{OUT} + 1V) ≤ V _{IN} ≤ 5.5V (Note 3)			0.4	
I _{EN}	EN Input Bias Current	EN = GND or V _{IN}		0.1	100	nA
T _{ON}	Turn-On Time	V _{OUT} at 95% of Final Value		80		μs
T _{OFF}	Turn-Off Time	I _{OUT} = 0mA (Note 5)		2.4		ms

Note 1: Absolute Maximum ratings indicate limits beyond which damage may occur. Electrical specifications do not apply when operating the device outside of its rated operating conditions.

Note 2: All voltages are with respect to the potential at the ground pin.

Note 3: Condition does not apply to input voltages below 2.2V since this is the minimum input operating voltage.

Note 4: Dropout voltage is measured by reducing V_{IN} until V_{OUT} drops 100mV from its nominal value at $V_{IN} - V_{OUT} = 1V$. Dropout voltage does not apply to the regulator versions with V_{OUT} less than 2.2V.

Note 5: Turn-off time is time measured between the enable input just decreasing below V_{IL} and the output voltage just decreasing to 10% of its nominal value.

Note 6: Maximum Power dissipation for the device is calculated using the following equations:

$$P_D = \frac{T_{J(MAX)} - T_A}{\theta_{JA}}$$

where $T_{J(MAX)}$ is the maximum junction temperature, T_A is the ambient temperature, and θ_{JA} is the junction-to-ambient thermal resistance. E.g. for the SOT-23-5 package $\theta_{JA} = 250^{\circ}C/W$, $T_{J(MAX)} = 150^{\circ}C$ and using $T_A = 25^{\circ}C$, the maximum power dissipation is found to be 500mW. The derating factor $(-1/\theta_{JA}) = -4mW/^{\circ}C$, thus below $25^{\circ}C$ the power dissipation figure can be increased by 4mW per degree, and similarly decreased by this factor for temperatures above $25^{\circ}C$. The value of the θ_{JA} for the TDFN-6 package is specifically dependent on the PCB trace area, trace material, and the number of layers and thermal vias.

Functional Block Diagram

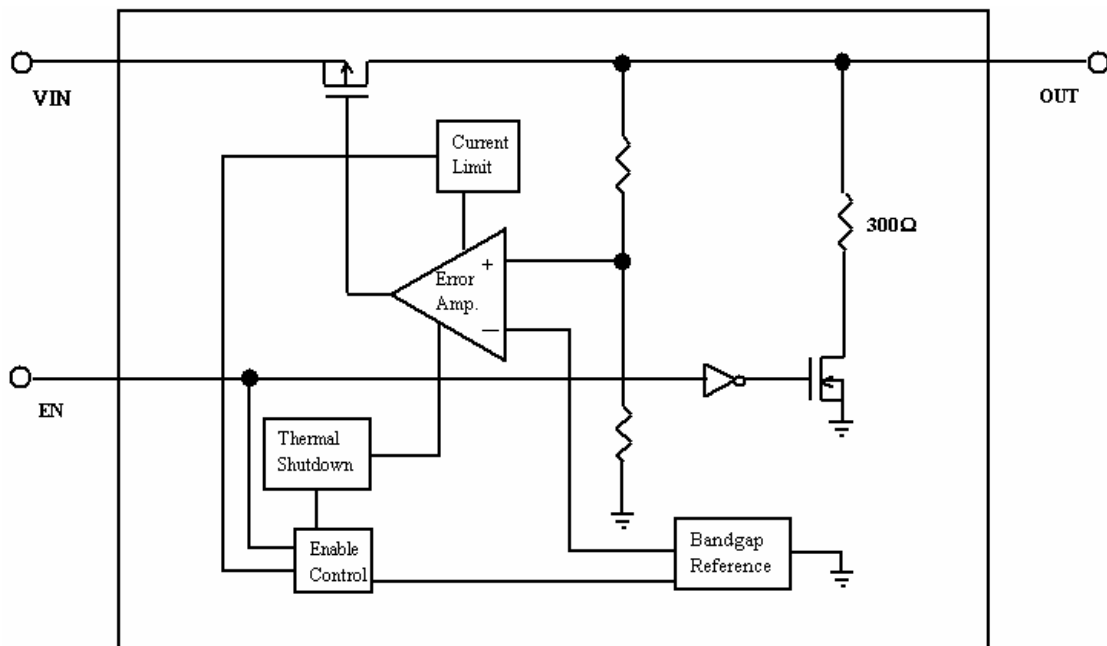

Typical Performance Characteristics

Unless otherwise specified, $V_{IN} = V_{OUT(NOM)} + 1V$, $V_{EN} = V_{IN}$, $C_{IN} = C_{OUT} = 2.2\mu F$, $T_A = 25^\circ C$.

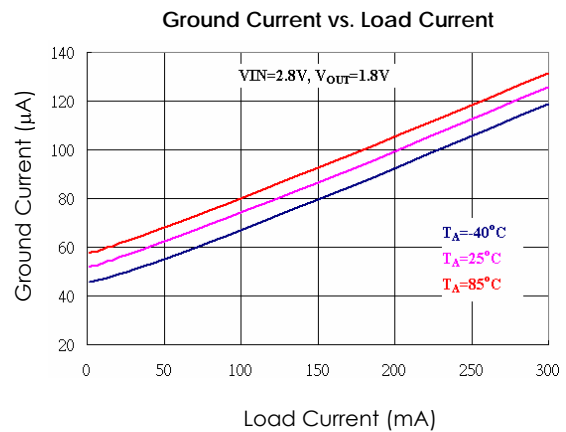
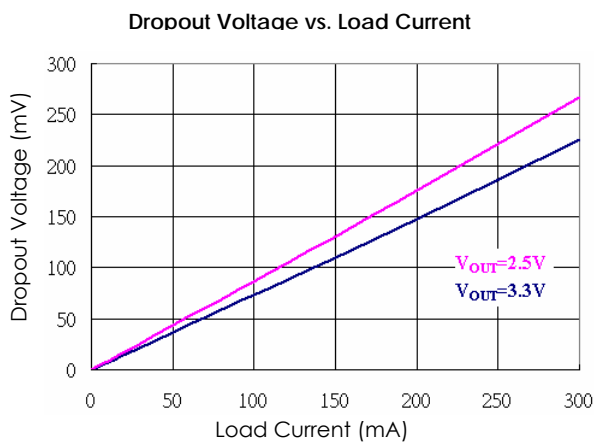
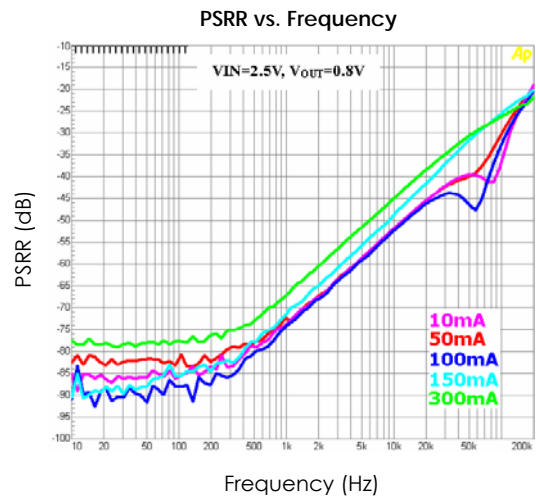
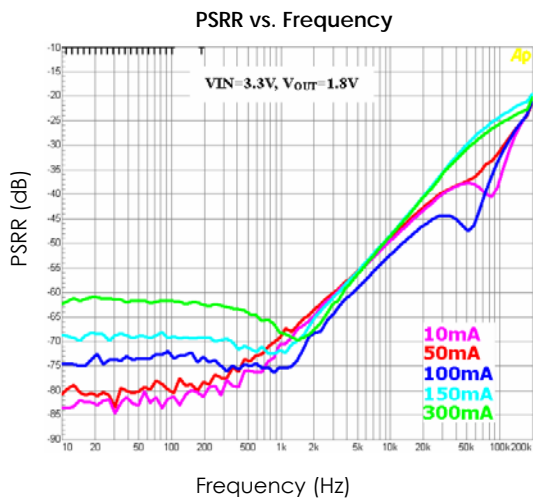
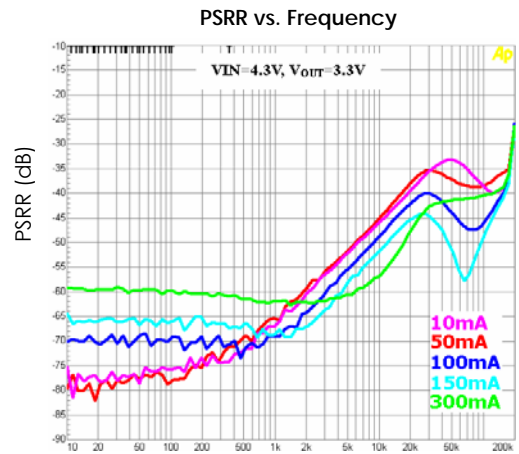
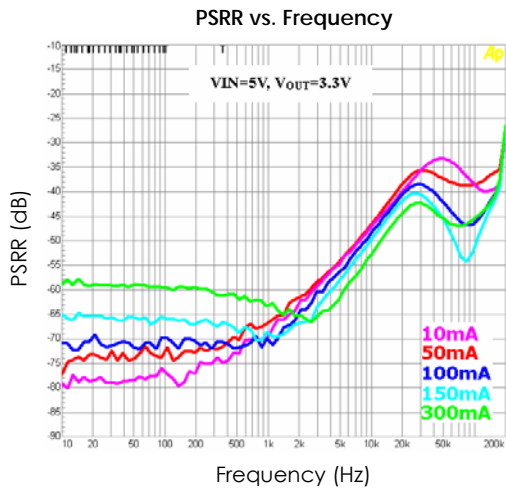

Typical Performance Characteristics

Unless otherwise specified, $V_{IN} = V_{OUT(NOM)} + 1V$, $V_{EN} = V_{IN}$, $C_{IN} = C_{OUT} = 2.2\mu F$, $T_A = 25^\circ C$. (Continued)

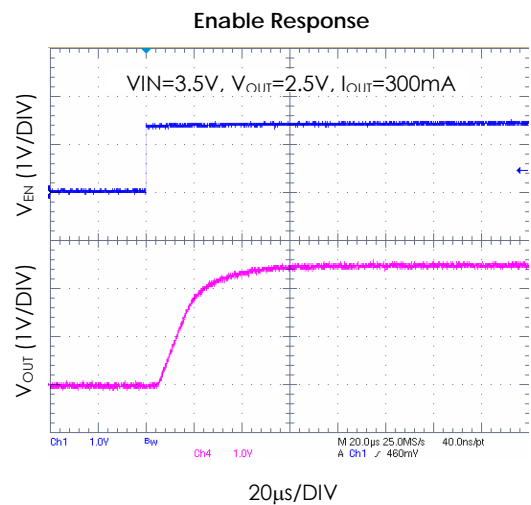
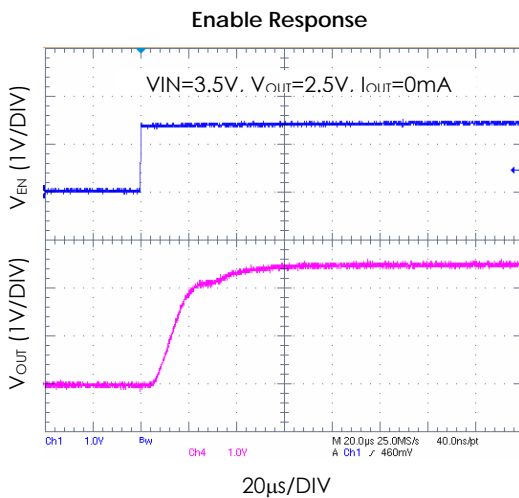
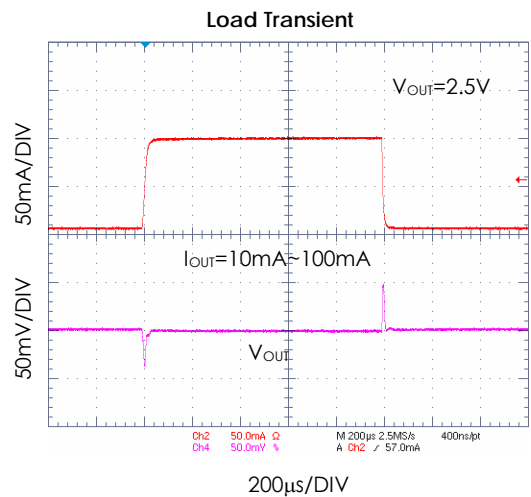
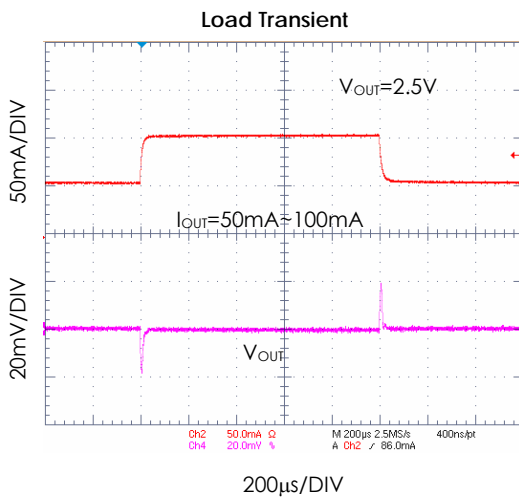
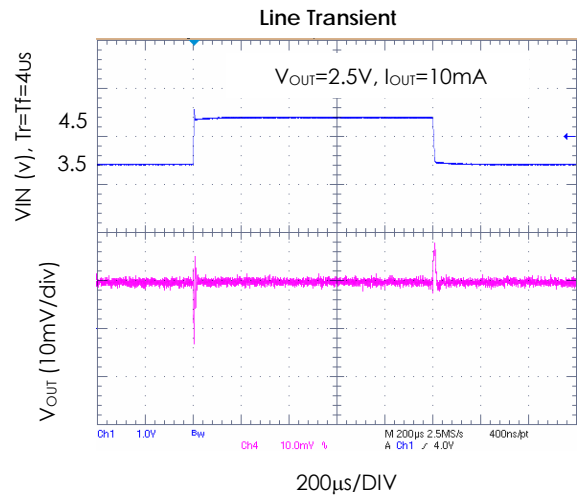
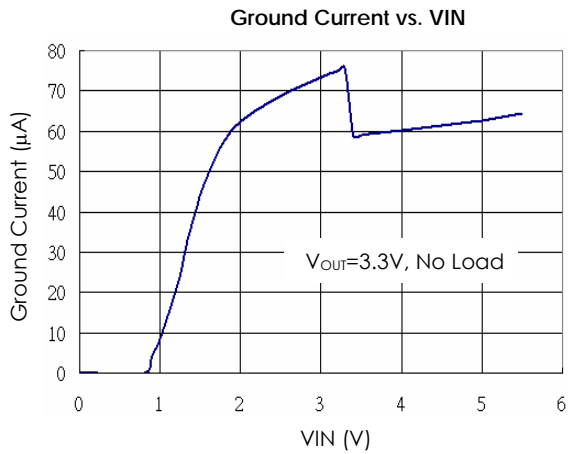

Typical Performance Characteristics

Unless otherwise specified, $V_{IN} = V_{OUT(NOM)} + 1V$, $V_{EN} = V_{IN}$, $C_{IN} = C_{OUT} = 2.2\mu F$, $T_A = 25^\circ C$. (Continued)

Enable Response

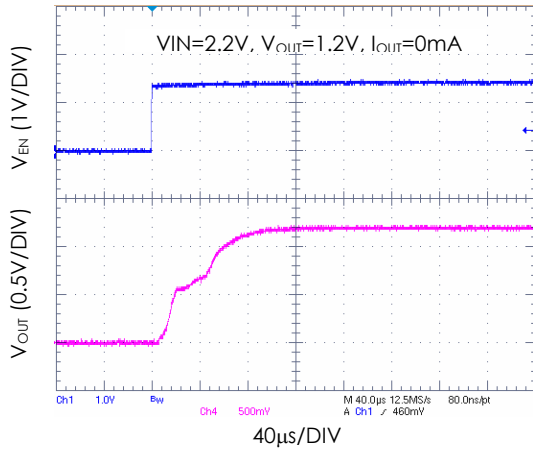

Enable Response

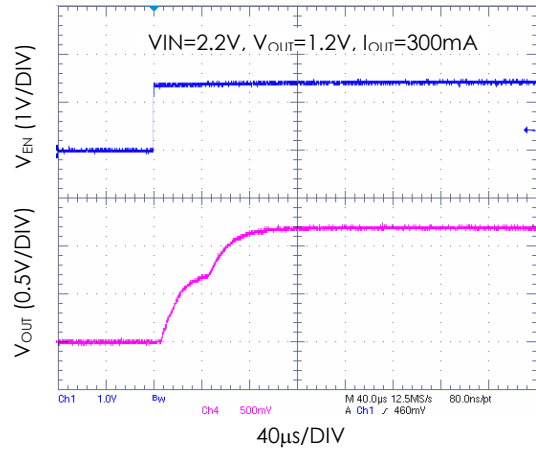

Disable Response

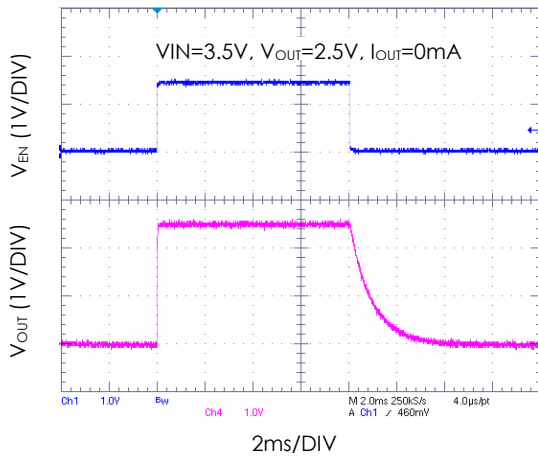

Disable Response

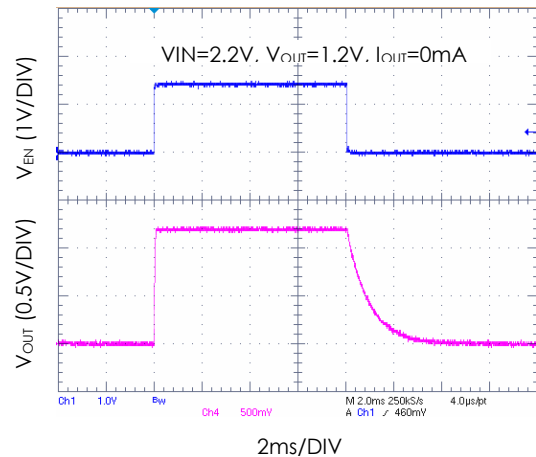

Power Derating (SOT-25)

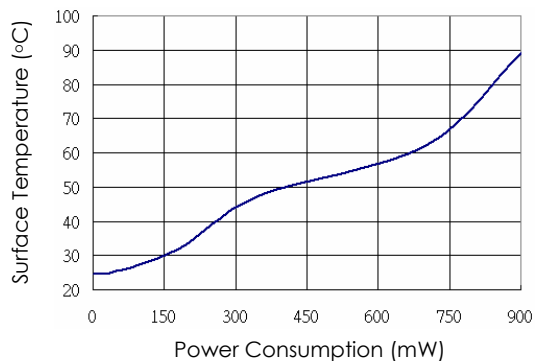

SOT-23-5

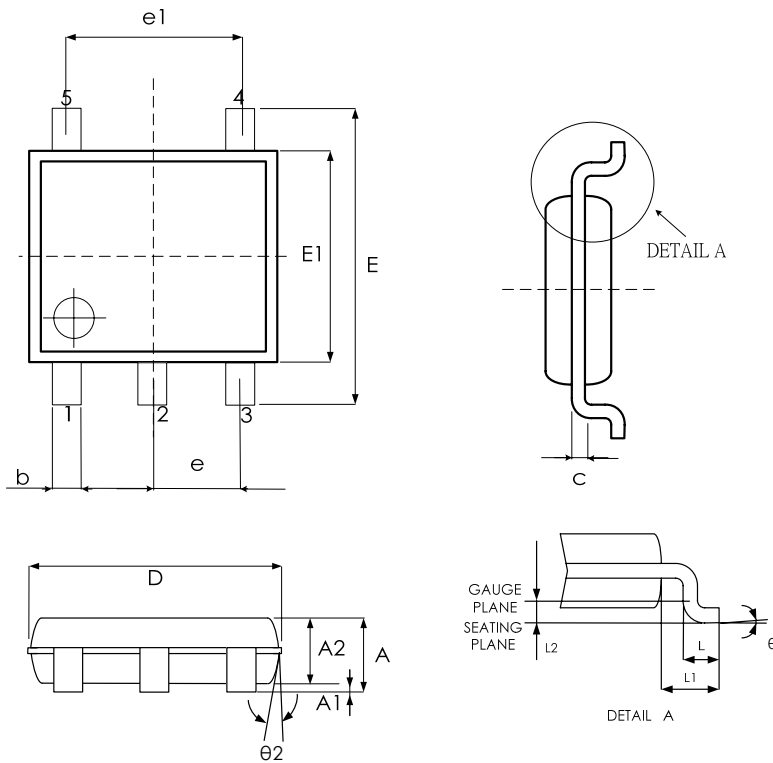

SYMBPLS	MIN.	NOM.	MAX.
A	1.05	1.20	1.35
A1	0.05	0.10	0.15
A2	1.00	1.10	1.20
b	0.30	—	0.50
c	0.08	—	0.20
D	2.80	2.90	3.00
E	2.60	2.80	3.00
E1	1.50	1.60	1.70
e	0.95 BSC		
e1	1.90 BSC		
L	0.30	0.45	0.55
L1	0.60 REF		
L2	0.25 REF		
θ°	0	5	10
$\theta 2^\circ$	6	8	10

UNIT: MM

TDFN-6

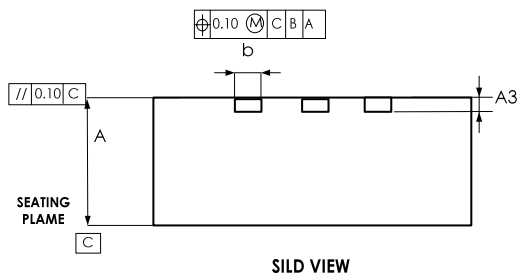
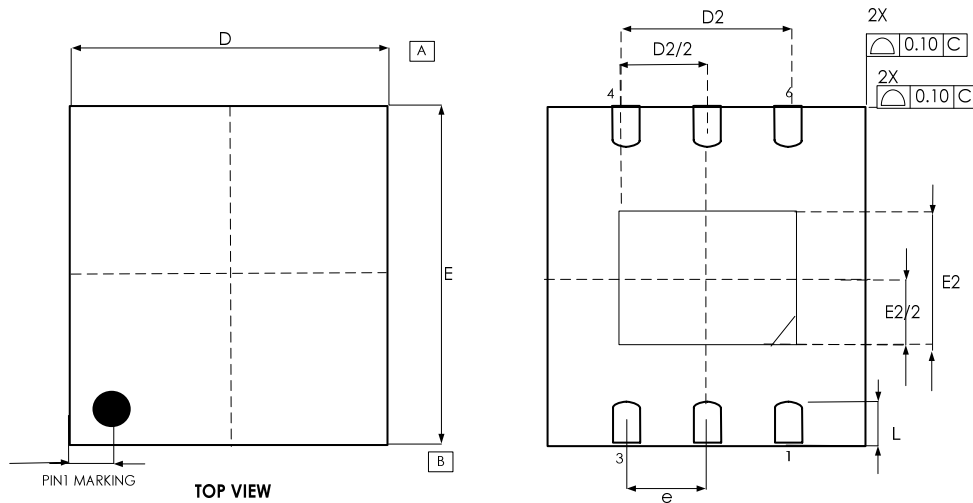

SYMBOL	COMMON					
	DIMENSIONS MILLIMETER			DIMENSIONS INCH		
	MIN.	NOM.	MAX.	MIN.	NOM.	MAX.
A	0.70	0.75	0.80	0.027	0.029	0.031
A3	0.200 REF			0.008 REF		
b	0.25	0.30	0.35	0.010	0.012	0.014
D	2.00 BSC			0.079 BSC		
D2	1.20	1.30	1.40	0.046	0.050	0.054
E	2.00 BSC			0.079 BSC		
E2	0.50	0.60	0.70	0.022	0.024	0.026
e	0.650 BSC			0.026 BSC		
L	0.25	0.30	0.35	0.009	0.011	0.013

SOT-353 (SC-70-5)

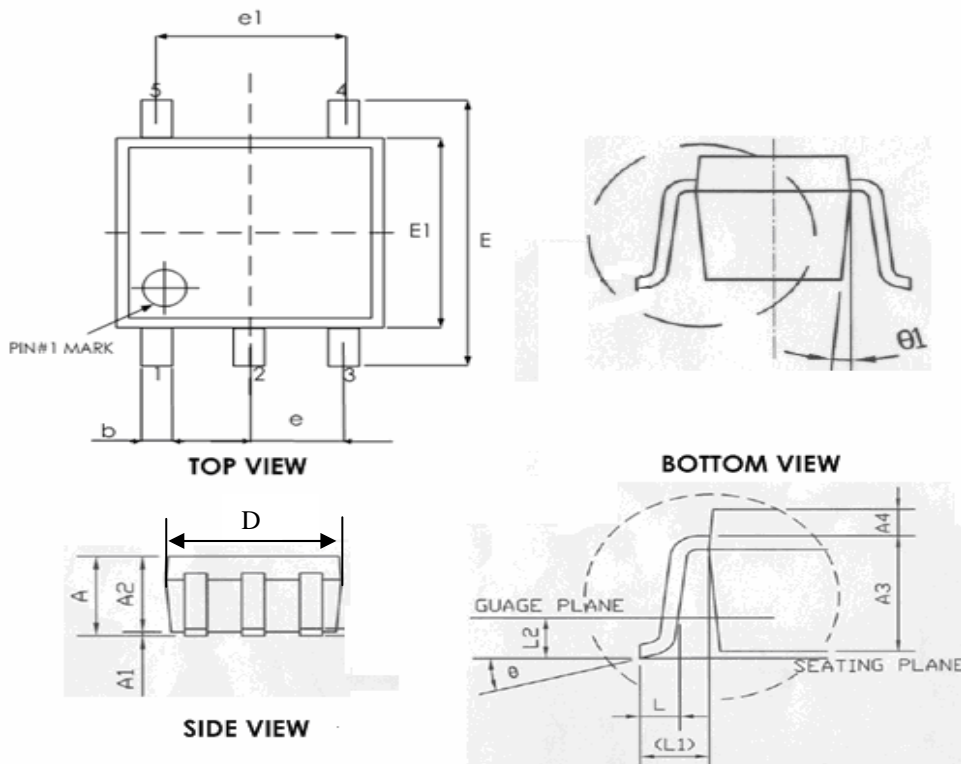

SYMBPLS	MIN.	NOM.	MAX.
A	0.80	—	1.10
A1	0	—	0.10
A2	0.80	0.90	1.00
A3	0.47	0.52	0.57
A4	0.33	0.38	0.43
b	0.15	—	0.30
c	0.08	—	0.22
D	1.85	2.00	2.15
E	1.80	2.10	2.40
E1	1.10	1.25	1.40
e	0.65 BSC		
e1	1.30 BSC		
L	0.26	0.36	0.46
L1	0.42 REF		
L2	0.15 BSC		
θ°	0	4	8
$\theta2^\circ$	4	—	12

UNIT: MM

SOT-343

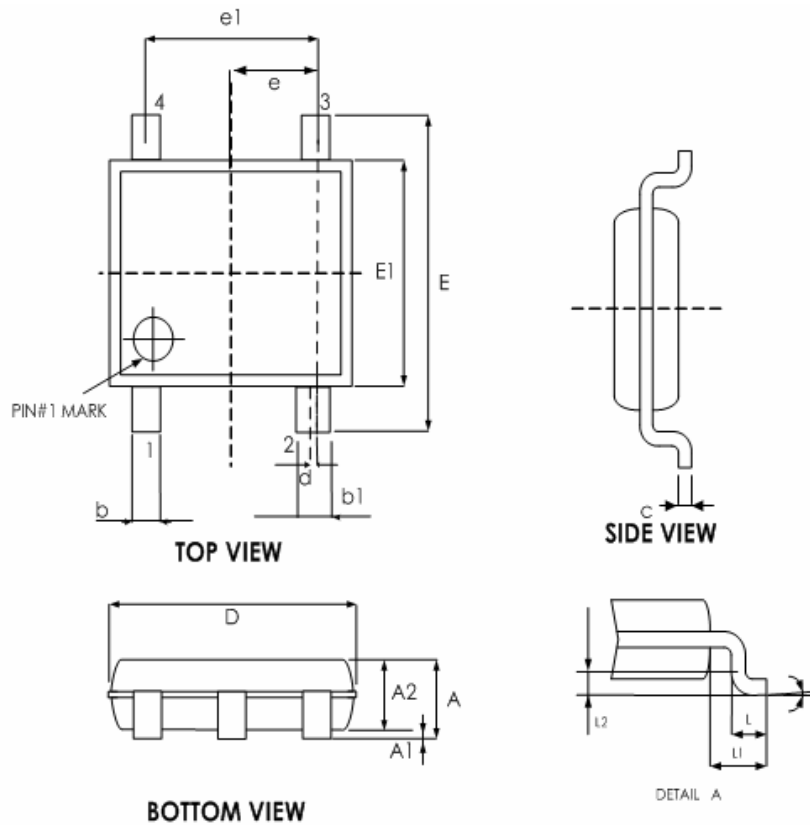

SYMBOL	COMMON			
	DIMENSIONS MILLIMETER		DIMENSIONS INCH	
	MIN.	MAX.	MIN.	MAX.
A	0.900	1.100	0.035	0.043
A1	0.000	0.100	0.000	0.004
A2	0.900	1.000	0.035	0.039
b	0.250	0.400	0.010	0.016
b1	0.350	0.500	0.014	0.020
c	0.080	0.150	0.003	0.006
d	0.050 TYP.		0.002 TYP.	
D	2.000	2.200	0.079	0.087
E	2.150	2.450	0.085	0.096
E1	1.150	1.350	0.045	0.053
e	0.650 TYP.		0.026 TYP.	
e1	1.200	1.400	0.047	0.055
L	0.260	0.460	0.010	0.018
L1	0.525 TYP.		0.021 TYP.	
L2	0.250 TYP.		0.010 TYP.	

Revision History

Revision	Date	Description
2.0	2009.05.08	EMP transferred from version 1.3
2.1	2009.06.23	<ol style="list-style-type: none">1. Delete FBP-6 & SOT-343 package (page 2)2. Delete FBP-6 & SOT-343 order information (page 3)3. Add order information SOT-23-5 Vout 1.2V、1.3V(page 3)4. Add SOT-353 package type (page 2)5. Add order information SOT-353 Vout 1.2V~3.3V (page 3)6. Delete FBP-6 & SOT-343 outline drawing (page 10~13)7. Add SOT-353 outline drawing (page 10~13)
2.2	2010.01.13	<ol style="list-style-type: none">1. Delete/Add some content in general description part (page 1)2. Delete SOT-23-5 NRR package (page 2)3. SC70-5 revised as SC-70-5 (page 2)4. Add SOT-343 connection diagram & order information (page 2)5. Add order, mark & packing information of SOT-343 (page 4)6. SOT-343/SOT353 (page 5)7. Add outline drawing of SOT-343 (page 13)
2.3	2011.03.18	Add D marking for SOT353 package in page12

Important Notice

All rights reserved.

No part of this document may be reproduced or duplicated in any form or by any means without the prior permission of ESMT.

The contents contained in this document are believed to be accurate at the time of publication. ESMT assumes no responsibility for any error in this document, and reserves the right to change the products or specification in this document without notice.

The information contained herein is presented only as a guide or examples for the application of our products. No responsibility is assumed by ESMT for any infringement of patents, copyrights, or other intellectual property rights of third parties which may result from its use. No license, either express, implied or otherwise, is granted under any patents, copyrights or other intellectual property rights of ESMT or others.

Any semiconductor devices may have inherently a certain rate of failure. To minimize risks associated with customer's application, adequate design and operating safeguards against injury, damage, or loss from such failure, should be provided by the customer when making application designs.

ESMT's products are not authorized for use in critical applications such as, but not limited to, life support devices or system, where failure or abnormal operation may directly affect human lives or cause physical injury or property damage. If products described here are to be used for such kinds of application, purchaser must do its own quality assurance testing appropriate to such applications.