

CAD Data

mm inch

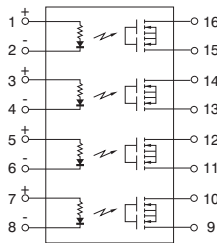

FEATURES

1. Built-in input resistor means less man-hours when mounting

The voltage-sensitive type, which eliminates the need to mount an external input resistor, is now available in a small package. Man-hours spent mounting external input resistors are cut and board designing is simplified.

2. Saves space on PC board

Since the small package size remains the same while including a built-in input resistor, space on the PC board is saved. This makes it easier to incorporate space savings when designing miniature devices.

3. Both low on-resistance (R type) and low capacitance (C type) available at excellent electrical characteristics of CxR10

- R type: On resistance 0.8Ω (typ.)
Output capacitance 14pF (typ.)
- C type: On resistance 9.5Ω (typ.)
Output capacitance 1.1pF (typ.)

TYPICAL APPLICATIONS

For multi-circuit switching;

- 1. Measuring and testing equipment**
Semiconductor testing equipment, Probe cards, Datalogger, Board tester and other testing equipment
- 2. Telecommunication and broadcasting equipment**
- 3. Medical equipment**

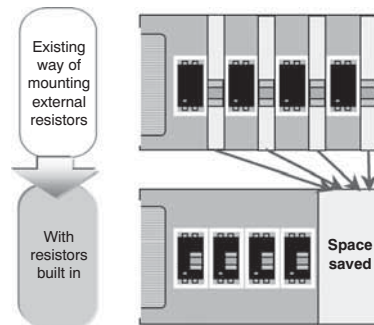

<Artistic impression of PC board space savings due to built-in resistor>
In case of SSOP.

TYPES

	Type	Output rating*1		Package	Part No.*2			Packing quantity	
		Load voltage	Load current		Tube packing style	Tape and reel packing style		Tube	Tape and reel
						Picked from the 1/2/3/4/5/6/7/8-pin side	Picked from the 9/10/11/12/13/14/15/16-pin side		
AC/DC dual use	Low on resistance (R type)	40 V	0.16A	SOP16-pin	AQS221FR2S	AQS221FR2SX	AQS221FR2SZ	1 tube contains: 50 pcs. 1 batch contains: 1,000 pcs.	1,000 pcs.
	Low capacitance (C type)	40 V	0.06A		AQS221FN2S	AQS221FN2SX	AQS221FN2SZ		

Notes: *1 Indicate the peak AC and DC values.

*2 The packing style indicator "X" or "Z" is not marked on the relay.

RATING

1. Absolute maximum ratings (Condition: ambient temperature 25°C 77°F)

Item	Symbol	AQS221FR2S	AQS221FN2S	Remarks
Input	Input voltage	6V		
	Input reverse voltage	5V		
	Power dissipation	260mW*		*65mW for 1a
Output	Load voltage (peak AC)	40V	40V	
	Load current	0.16A	0.06A	Peak AC, DC
	Peak load current	0.2A	0.12A	100ms (1shot), V _L =DC
	Power dissipation	600mW		
Total power dissipation	P _T	650mW		
I/O isolation voltage	V _{iso}	500V AC		
Operating temperature	T _{opr}	-40°C to +85°C -40°F to +185°F		Non-condensing at low temperatures
Storage temperature	T _{stg}	-40°C to +100°C -40°F to +212°F		

RF SOP 4 Form A CxR10 Voltage-sensitive (AQS221F○2S)

2. Electrical characteristics (Condition: ambient temperature 25°C 77°F)

Item		Symbol	AQS221FR2S	AQS221FN2S	Condition	
Input	Operate voltage	Typ.	1.3V		$I_L = \text{Max.}$	
		Max.	4V			
	Turn off voltage	Min.	0.8V			
		Typ.	1.3V			
Input current	Typ.	8.5mA		$V_{IN} = 5V$		
Output	On resistance	Typ.	0.75Ω	9.5Ω	$V_{IN} = 5V$ $I_L = \text{Max.}$ Within 1 s on time	
		Max.	1.25Ω	12.5Ω		
	Output capacitance	Typ.	12.5pF	1pF	$V_{IN} = 0V$ $V_B = 0V$ $f = 1\text{MHz}$	
		Max.	18pF	1.5pF		
	Off state leakage current	Typ.	0.02nA	0.01nA	$V_{IN} = 0V$ $V_L = \text{Max.}$	
		Max.	10nA			
Transfer characteristics	Turn on time*	Typ.	0.07ms	0.02ms	AQS221FR2S: $V_{IN} = 5V, I_L = \text{Max.}$ AQS221FN2S: $V_{IN} = 5V, V_L = 10V, R_L = 500\Omega$	
		Max.	0.5ms			
	Turn off time*	Typ.	0.07ms	0.02ms		
		Max.	0.2ms			
	I/O capacitance	Typ.	0.8pF			$f = 1\text{MHz}, V_B = 0V$
		Max.	1.5pF			$f = 1\text{MHz}, V_B = 0V$
Initial I/O isolation resistance	Min.	1,000MΩ		500V DC		

Note: If you wish to change the input voltage, rating or performance, please inquire with our sales.

*Turn on/Turn off time

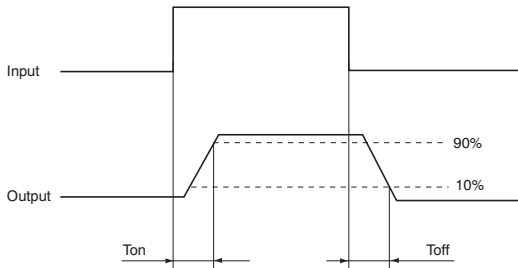

RECOMMENDED OPERATING CONDITIONS

Please obey the following conditions to ensure proper relay operation and resetting.

Item	Symbol	Minimum	Typical	Maximum	Unit
Input voltage	V_{IN}	4.5	5	5.5	V

■ Dimensions

■ Schematic and Wiring Diagrams

■ Cautions for Use

■ These products are not designed for automotive use.

If you are considering to use these products for automotive applications, please contact your local Panasonic Electric Works technical representative.

Please refer to our information on [PhotoMOS Relays for Automotive Applications](#).

RF SOP 4 Form A CxR10 Voltage-sensitive (AQS221FO2S)

REFERENCE DATA

1. Load current vs. ambient temperature characteristics

Allowable ambient temperature: -40°C to $+85^{\circ}\text{C}$
 -40°F to $+185^{\circ}\text{F}$

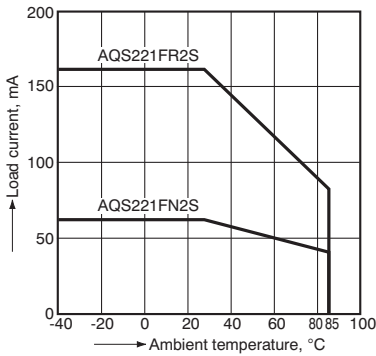

2. Load current vs. Load voltage characteristics
 Ambient temperature: 25°C 77°F

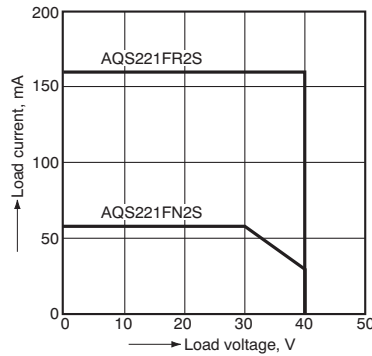

3. On resistance vs. ambient temperature characteristics

Input voltage: 5V; Load voltage: 10V (DC);
 Continuous load current: 160mA (DC) R type,
 60mA (DC) C type

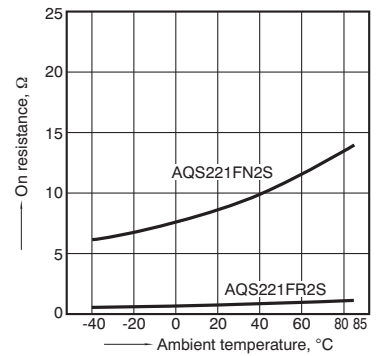

4. Turn on time vs. ambient temperature characteristics

Input voltage: 5V; Load voltage: 10V (DC);
 Continuous load current: 125mA (DC) R type,
 20mA (DC) C type

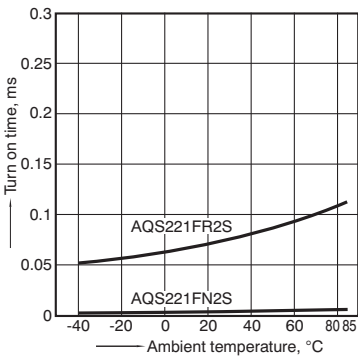

5. Turn off time vs. ambient temperature characteristics

Input voltage: 5V; Load voltage: 10V (DC);
 Continuous load current: 125mA (DC) R type,
 20mA (DC) C type

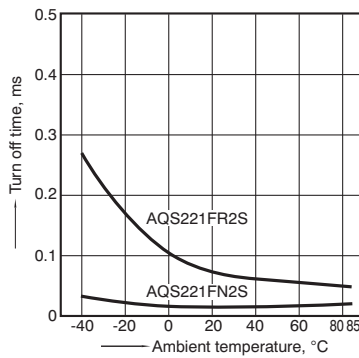

6. Turn on voltage vs. ambient temperature characteristics

Load voltage: 10V (DC);
 Continuous load current: 160mA (DC) R type,
 60mA (DC) C type

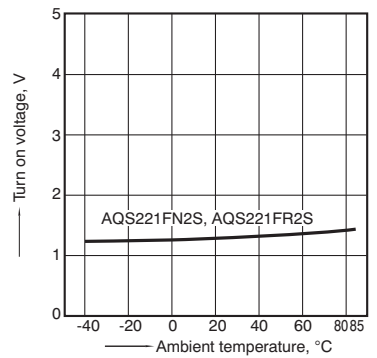

7. Turn off voltage vs. ambient temperature characteristics

Load voltage: 10V (DC);
 Continuous load current: 160mA (DC) R type,
 60mA (DC) C type

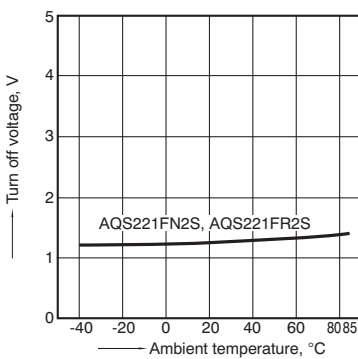

8. Input current vs. ambient temperature characteristics

Input voltage: 5V

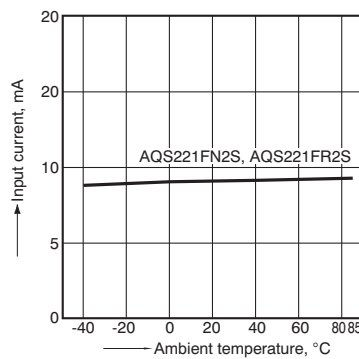

9. Current vs. voltage characteristics of output at MOS portion

Ambient temperature: 25°C 77°F

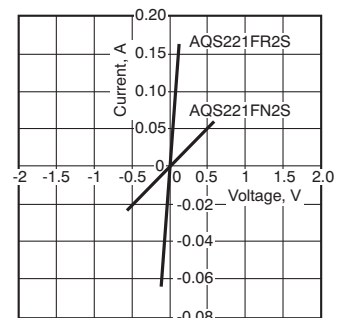

RF SOP 4 Form A CxR10 Voltage-sensitive (AQS221F○2S)

10. Input current vs. input voltage characteristics

Ambient temperature: 25°C 77°F
(Recommended input voltage: 5±0.5V)

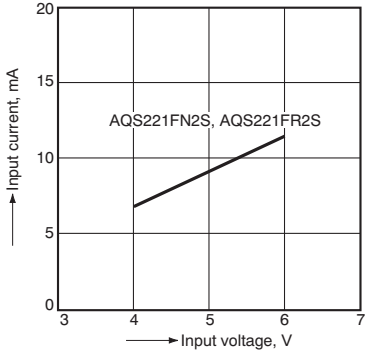

11. Off state leakage current vs. load voltage characteristics

Measured portion: between terminals 3 and 4
Ambient temperature: 25°C 77°F

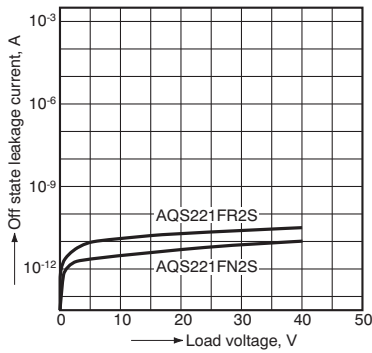

12. Turn on time vs. input voltage characteristics

Load voltage: 10V (DC);
Continuous load current: 125mA (DC) R type,
20mA (DC) C type; Ambient temperature: 25°C 77°F

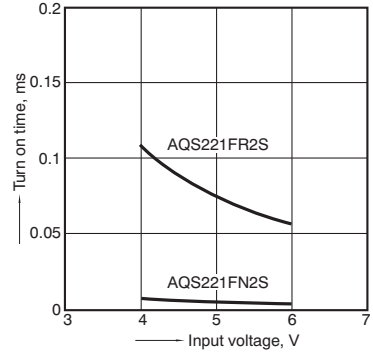

13. Turn off time vs. input voltage characteristics

Load voltage: 10V (DC);
Continuous load current: 125mA (DC) R type,
20mA (DC) C type; Ambient temperature: 25°C 77°F

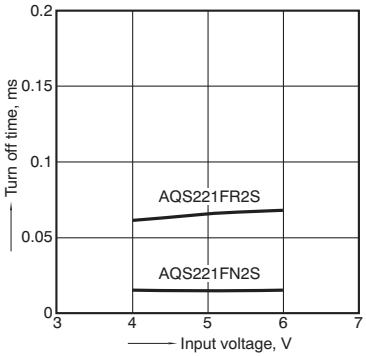

14. Output capacitance vs. applied voltage characteristics

Measured portion: between terminals 3 and 4
Frequency: 1 MHz, 30m Vrms;
Ambient temperature: 25°C 77°F

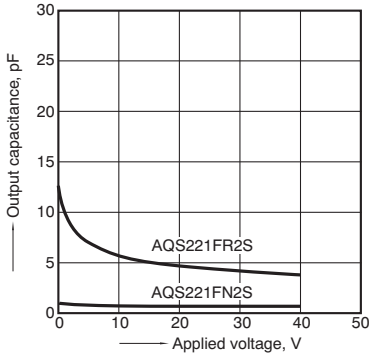

15. Isolation vs. frequency characteristics (50Ω impedance)

Measured portion: between terminals 3 and 4
Ambient temperature: 25°C 77°F

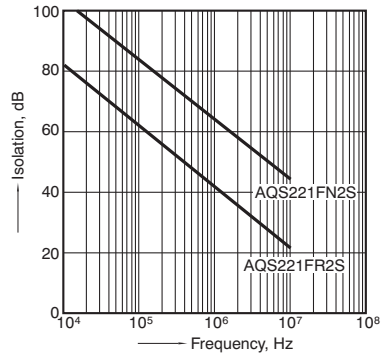

16. Insertion loss vs. frequency characteristics (50Ω impedance)

Measured portion: between terminals 3 and 4
Ambient temperature: 25°C 77°F

