

- Advanced Process Technology
- Optimized for Automotive Motor Drive, DC-DC and other Heavy Load Applications
- Exceptionally Small Footprint and Low Profile
- High Power Density
- Low Parasitic Parameters
- Dual Sided Cooling
- 175°C Operating Temperature
- Repetitive Avalanche Capability for Robustness and Reliability
- Lead Free, RoHS Compliant and Halogen Free
- Automotive Qualified *

$V_{(BR)DSS}$	40V
$R_{DS(on)}$ typ.	3.8mΩ
	max.
I_D (Silicon Limited)	72A
Q_g	48nC

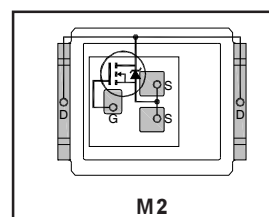

Applicable DirectFET® Outline and Substrate Outline ①

SB	SC		M2	M4		L4	L6	L8	
----	----	--	-----------	----	--	----	----	----	--

Description

The AUIRF7734M2 combines the latest Automotive HEXFET® Power MOSFET Silicon technology with the advanced DirectFET® packaging technology to achieve exceptional performance in a package that has the footprint of an SO-8 or 5X6mm PQFN and only 0.7mm profile. The DirectFET® package is compatible with existing layout geometries used in power applications, PCB assembly equipment and vapor phase, infrared or convection soldering techniques, when application note AN-1035 is followed regarding the manufacturing methods and processes. The DirectFET® package allows dual sided cooling to maximize thermal transfer in automotive power systems.

This HEXFET® Power MOSFET is designed for applications where efficiency and power density are of value. The advanced DirectFET® packaging platform coupled with the latest silicon technology allows the AUIRF7734M2 to offer substantial system level savings and performance improvement specifically in motor drive, high frequency DC-DC and other heavy load applications on ICE, HEV and EV platforms. This MOSFET utilizes the latest processing techniques to achieve low on-resistance and low Q_g per silicon area. Additional features of this MOSFET are 175°C operating junction temperature and high repetitive peak current capability. These features combine to make this MOSFET a highly efficient, robust and reliable device for high current automotive applications.

Absolute Maximum Ratings

Stresses beyond those listed under "Absolute Maximum Ratings" may cause permanent damage to the device. These are stress ratings only; and functional operation of the device at these or any other condition beyond those indicated in the specifications is not implied. Exposure to absolute-maximum-rated conditions for extended periods may affect device reliability. The thermal resistance and power dissipation ratings are measured under board mounted and still air conditions. Ambient temperature (T_A) is 25°C, unless otherwise specified.

	Parameter	Max.	Units
V_{DS}	Drain-to-Source Voltage	40	V
V_{GS}	Gate-to-Source Voltage	± 20	
$I_D @ T_C = 25^\circ\text{C}$	Continuous Drain Current, $V_{GS} @ 10\text{V}$ (Silicon Limited)④	72	A
$I_D @ T_C = 100^\circ\text{C}$	Continuous Drain Current, $V_{GS} @ 10\text{V}$ (Silicon Limited)④	51	
$I_D @ T_A = 25^\circ\text{C}$	Continuous Drain Current, $V_{GS} @ 10\text{V}$ (Silicon Limited)③	17	
I_{DM}	Pulsed Drain Current ⑤	288	
$P_D @ T_C = 25^\circ\text{C}$	Power Dissipation ④	46	W
$P_D @ T_A = 25^\circ\text{C}$	Power Dissipation ③	2.5	
E_{AS}	Single Pulse Avalanche Energy (Thermally Limited) ⑥	56	mJ
$E_{AS}(\text{tested})$	Single Pulse Avalanche Energy Tested Value ⑥	164	
I_{AR}	Avalanche Current ⑤	See Fig. 18a, 18b, 16, 17	A
E_{AR}	Repetitive Avalanche Energy ⑤		mJ
T_P	Peak Soldering Temperature	270	°C
T_J	Operating Junction and	-55 to + 175	
T_{STG}	Storage Temperature Range		

Thermal Resistance

	Parameter	Typ.	Max.	Units
$R_{\theta JA}$	Junction-to-Ambient ③	—	60	°C/W
$R_{\theta JA}$	Junction-to-Ambient ⑥	12.5	—	
$R_{\theta JA}$	Junction-to-Ambient ⑥	20	—	
$R_{\theta JCan}$	Junction-to-Can ④⑥	—	3.3	
$R_{\theta J-PCB}$	Junction-to-PCB Mounted	1.0	—	
	Linear Derating Factor ④	0.30		W/°C

HEXFET® is a registered trademark of International Rectifier.

*Qualification standards can be found at <http://www.irf.com/>

Static Characteristics @ $T_J = 25^\circ\text{C}$ (unless otherwise stated)

	Parameter	Min.	Typ.	Max.	Units	Conditions
$V_{(BR)DSS}$	Drain-to-Source Breakdown Voltage	40	—	—	V	$V_{GS} = 0V, I_D = 250\mu A$
$\Delta V_{(BR)DSS}/\Delta T_J$	Breakdown Voltage Temp. Coefficient	—	0.03	—	$V/^\circ\text{C}$	Reference to $25^\circ\text{C}, I_D = 1\text{mA}$
$R_{DS(on)}$	Static Drain-to-Source On-Resistance	—	3.8	4.9	$m\Omega$	$V_{GS} = 10V, I_D = 43A$ ⑦
$V_{GS(th)}$	Gate Threshold Voltage	2.0	3.0	4.0	V	$V_{DS} = V_{GS}, I_D = 100\mu A$
$\Delta V_{GS(th)}/\Delta T_J$	Gate Threshold Voltage Coefficient	—	-9.3	—	$mV/^\circ\text{C}$	
g_{fs}	Forward Transconductance	74	—	—	S	$V_{DS} = 10V, I_D = 43A$
R_G	Gate Resistance	—	1.0	—	Ω	
I_{DSS}	Drain-to-Source Leakage Current	—	—	5	μA	$V_{DS} = 40V, V_{GS} = 0V$
		—	—	250		$V_{DS} = 40V, V_{GS} = 0V, T_J = 125^\circ\text{C}$
I_{GSS}	Gate-to-Source Forward Leakage	—	—	100	nA	$V_{GS} = 20V$
	Gate-to-Source Reverse Leakage	—	—	-100		$V_{GS} = -20V$

Dynamic Characteristics @ $T_J = 25^\circ\text{C}$ (unless otherwise stated)

	Parameter	Min.	Typ.	Max.	Units	Conditions
Q_g	Total Gate Charge	—	48	72	nC	$V_{DS} = 20V$ $V_{GS} = 10V$ $I_D = 43A$
Q_{gs1}	Pre-V _{th} Gate-to-Source Charge	—	6.9	—		
Q_{gs2}	Post-V _{th} Gate-to-Source Charge	—	4.1	—		
Q_{gd}	Gate-to-Drain ("Miller") Charge	—	16	—		
Q_{godr}	Gate Charge Overdrive	—	21	—		
Q_{sw}	Switch Charge ($Q_{gs2} + Q_{gd}$)	—	20.1	—	nC	$V_{DS} = 16V, V_{GS} = 0V$
Q_{oss}	Output Charge	—	21	—		
$t_{d(on)}$	Turn-On Delay Time	—	13	—	ns	$V_{DD} = 20V, V_{GS} = 10V$ ⑧ $I_D = 43A$ $R_G = 6.8\Omega$
t_r	Rise Time	—	49	—		
$t_{d(off)}$	Turn-Off Delay Time	—	42	—		
t_f	Fall Time	—	45	—		
C_{iss}	Input Capacitance	—	2545	—	pF	$V_{GS} = 0V$ $V_{DS} = 25V$ $f = 1.0\text{MHz}$
C_{oss}	Output Capacitance	—	587	—		
C_{riss}	Reverse Transfer Capacitance	—	324	—		
C_{oss}	Output Capacitance	—	2174	—		
C_{oss}	Output Capacitance	—	525	—		
$C_{oss \text{ eff.}}$	Effective Output Capacitance	—	806	—		
						$V_{GS} = 0V, V_{DS} = 0V \text{ to } 32V$

Diode Characteristics @ $T_J = 25^\circ\text{C}$ (unless otherwise stated)

	Parameter	Min.	Typ.	Max.	Units	Conditions
I_S	Continuous Source Current (Body Diode)	—	—	72	A	MOSFET symbol showing the integral reverse p-n junction diode. 
I_{SM}	Pulsed Source Current (Body Diode) ⑨	—	—	288		
V_{SD}	Diode Forward Voltage	—	—	1.3	V	$I_S = 43A, V_{GS} = 0V$ ⑦
t_{rr}	Reverse Recovery Time	—	38	57	ns	$I_F = 43A, V_{DD} = 25V$
Q_{rr}	Reverse Recovery Charge	—	26	39	nC	$di/dt = 100A/\mu s$ ⑦

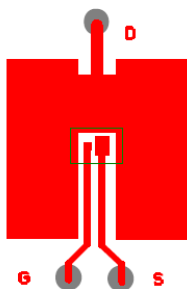

③ Surface mounted on 1 in. square Cu (still air).

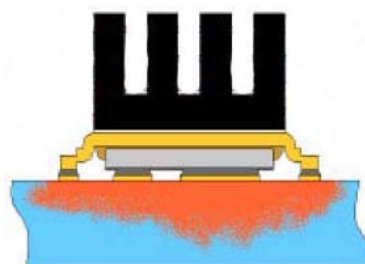

④ Mounted to a PCB with small clip heatsink (still air)

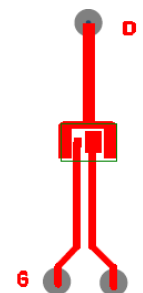

⑤ Mounted on minimum footprint full size board with metalized back and with small clip heatsink (still air)

Notes ① through ⑩ are on page 11

Qualification Information[†]

Qualification Level		Automotive (per AEC-Q101) ^{††}	
		Comments: This part number(s) passed Automotive qualification. IR's Industrial and Consumer qualification level is granted by extension of the higher Automotive level.	
Moisture Sensitivity Level		MEDIUM-CAN	MSL1, 260°C
ESD	Machine Model	Class M3 (+/- 400V) AEC-Q101-002	
	Human Body Model	Class H1B (+/- 1000V) AEC-Q101-001	
	Charged Device Model	N/A AEC-Q101-005	
RoHS Compliant		Yes	

[†] Qualification standards can be found at International Rectifier's web site: <http://www.irf.com/>

^{††} Exceptions to AEC-Q101 requirements are noted in the qualification report.

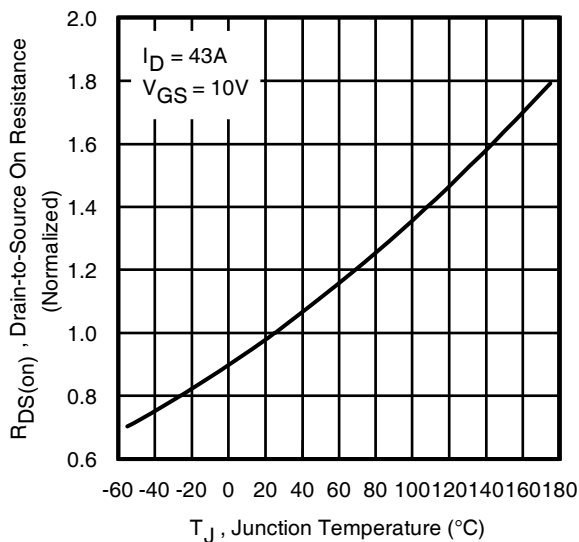
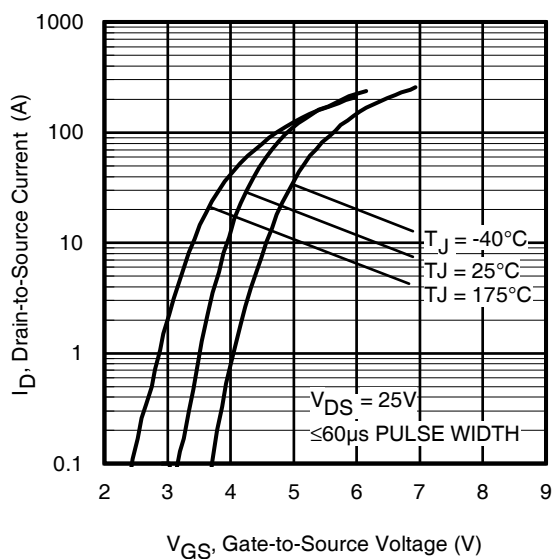
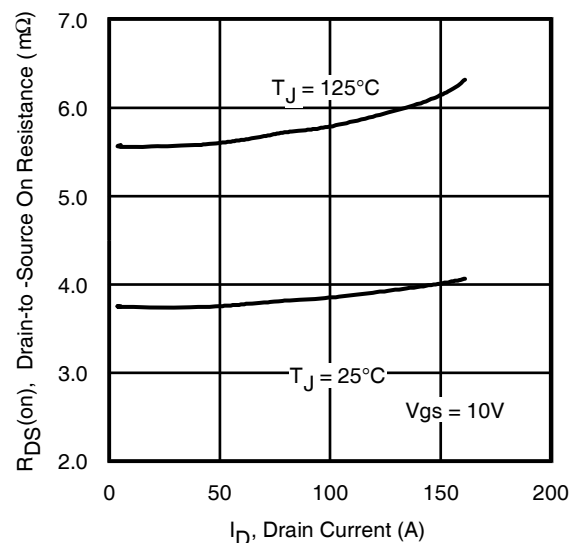
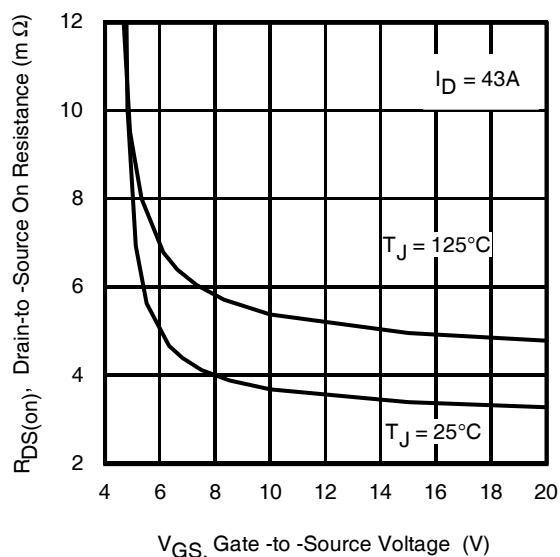
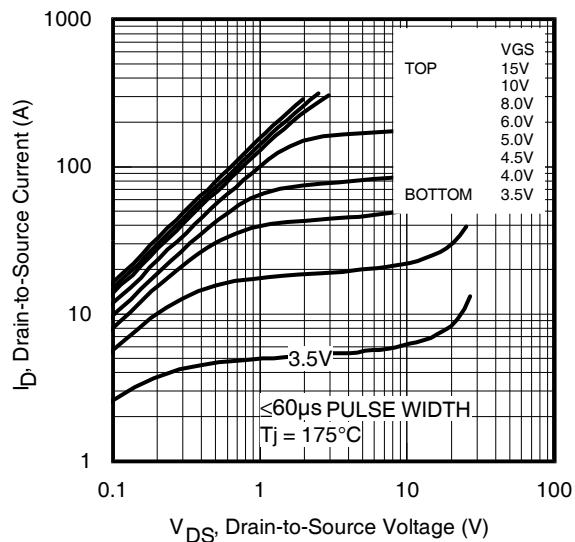
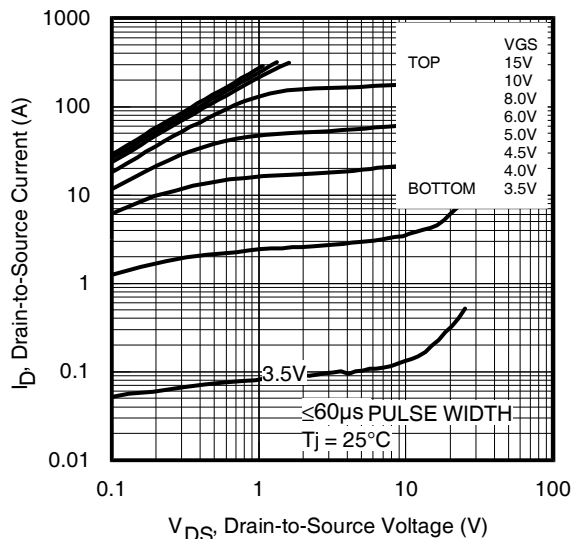

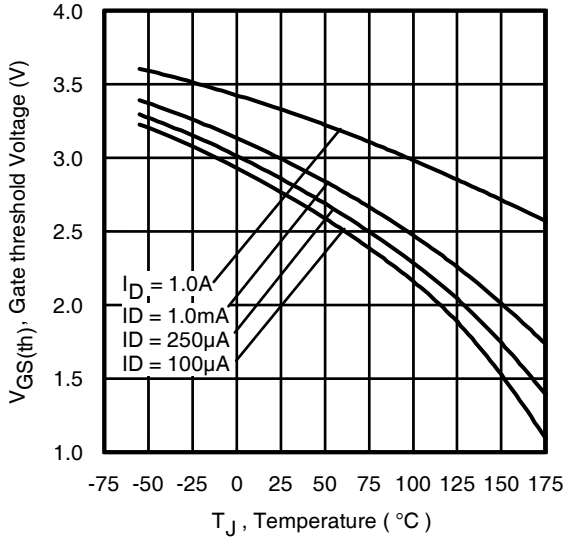

Fig 7. Typical Threshold Voltage vs. Junction Temperature

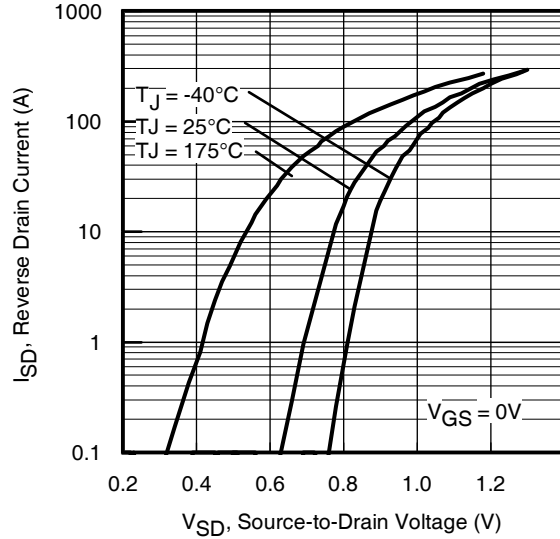

Fig 8. Typical Source-Drain Diode Forward Voltage

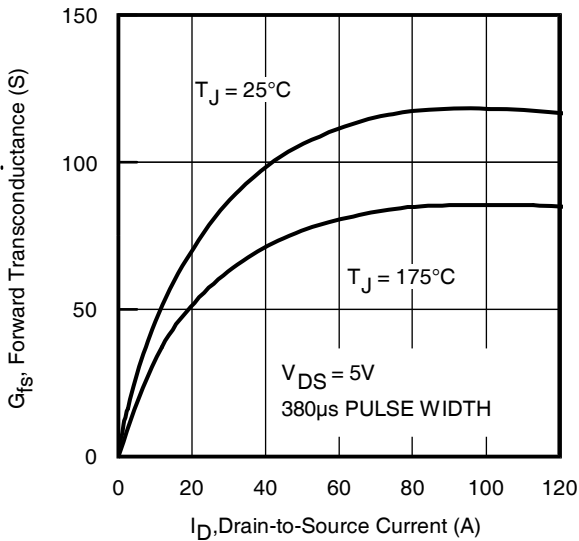

Fig 9. Typical Forward Transconductance vs. Drain Current

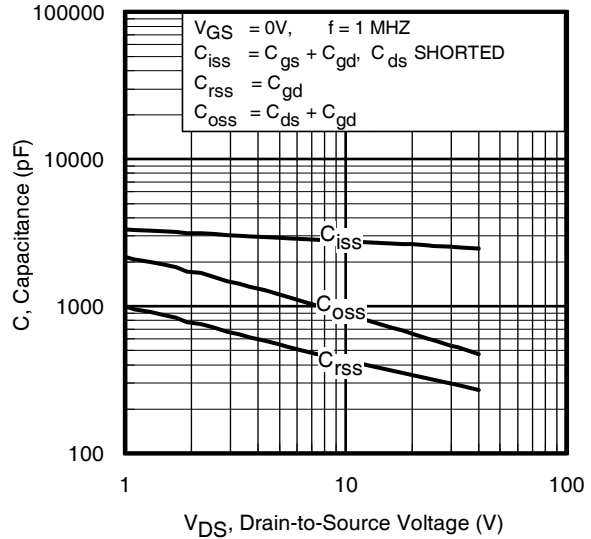

Fig 10. Typical Capacitance vs. Drain-to-Source Voltage

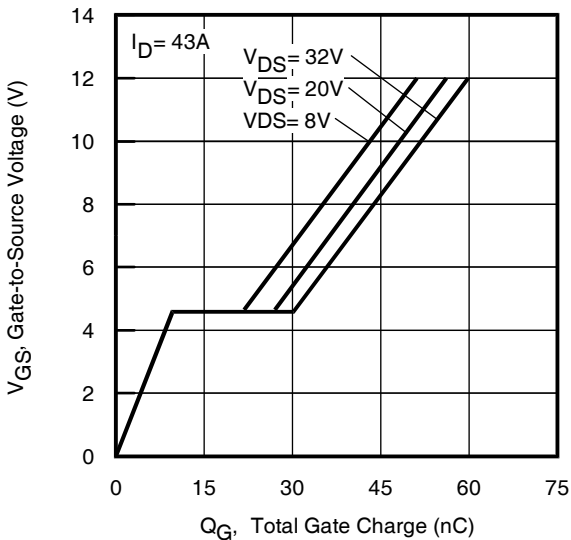

Fig.11 Typical Gate Charge vs. Gate-to-Source Voltage
www.irf.com

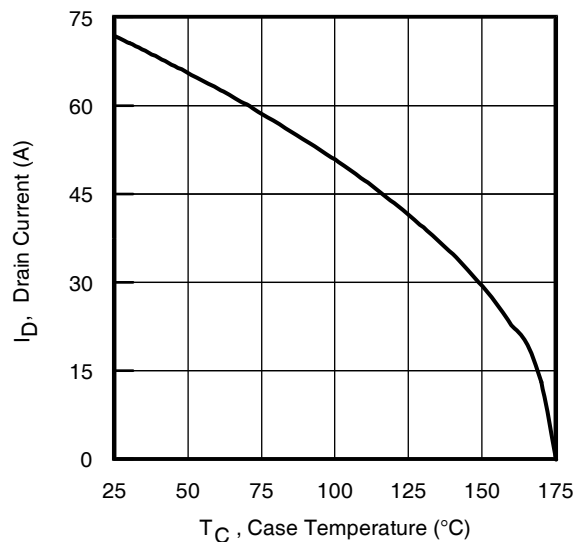

Fig 12. Maximum Drain Current vs. Case Temperature

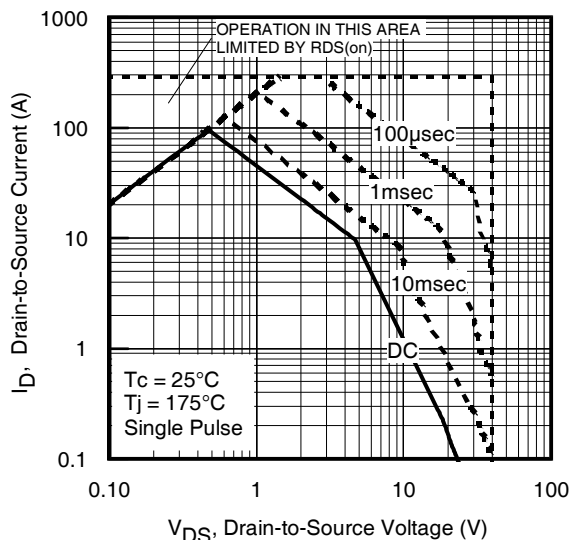

Fig 13. Maximum Safe Operating Area

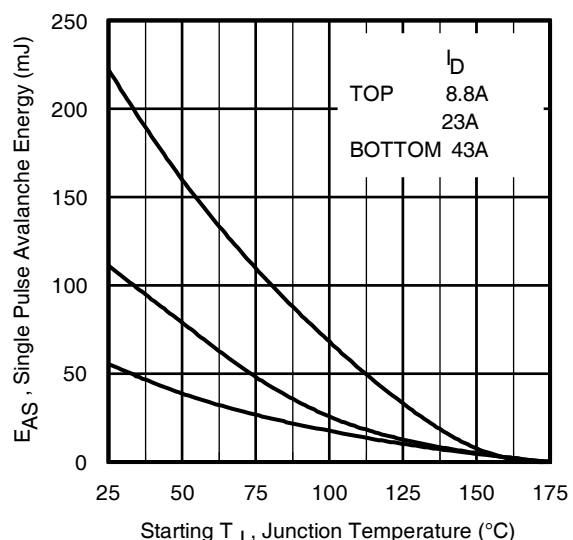

Fig 14. Maximum Avalanche Energy vs. Temperature

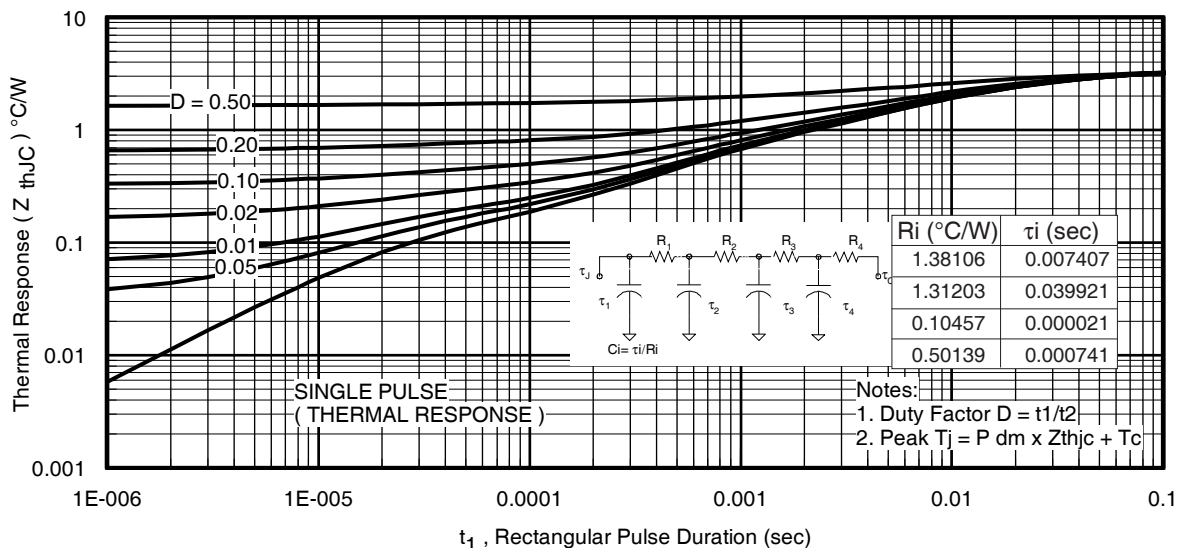

Fig 15. Maximum Effective Transient Thermal Impedance, Junction-to-Case

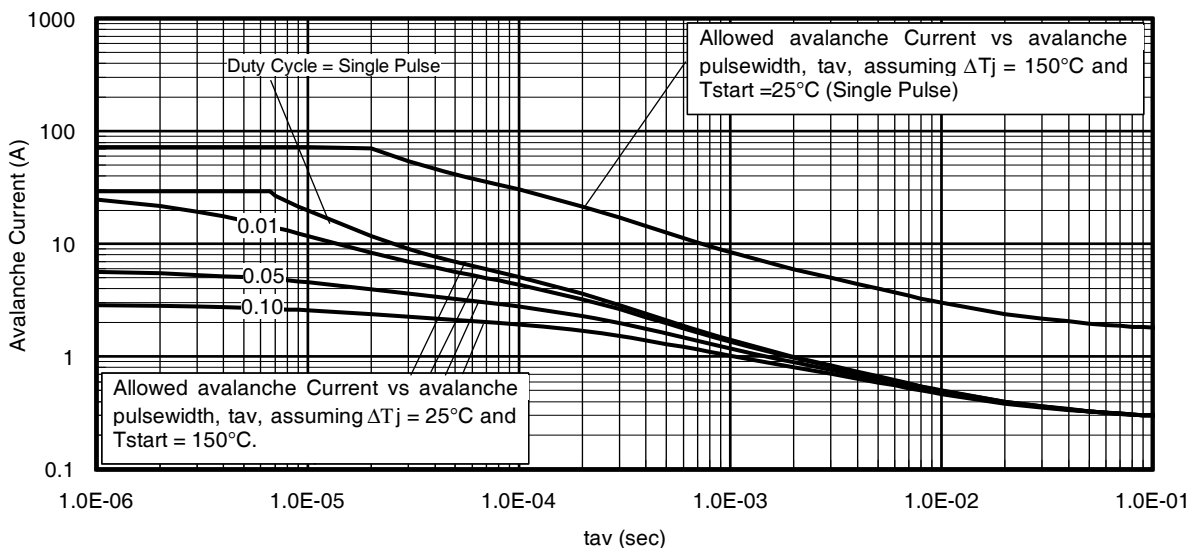

Fig 16. Typical Avalanche Current vs. Pulsewidth

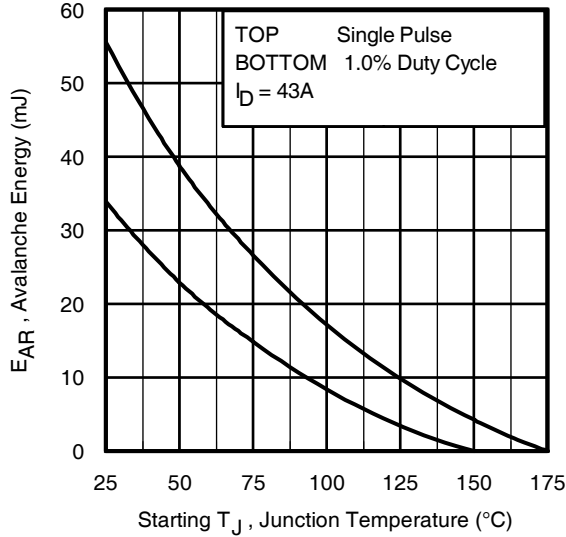

Fig 17. Maximum Avalanche Energy vs. Temperature

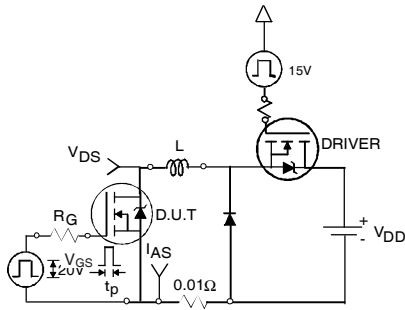

Fig 18a. Unclamped Inductive Test Circuit

$$P_{D(ave)} = 1/2 (1.3 \cdot BV \cdot I_{av}) = \Delta T / Z_{thJC}$$

$$I_{av} = 2\Delta T / [1.3 \cdot BV \cdot Z_{th}]$$

$$E_{AS(AR)} = P_{D(ave)} \cdot t_{av}$$

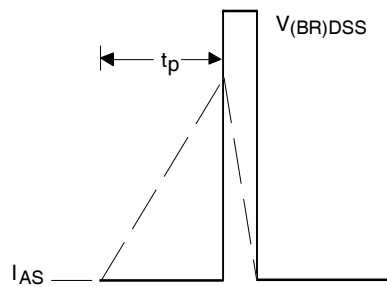

Fig 18b. Unclamped Inductive Waveforms

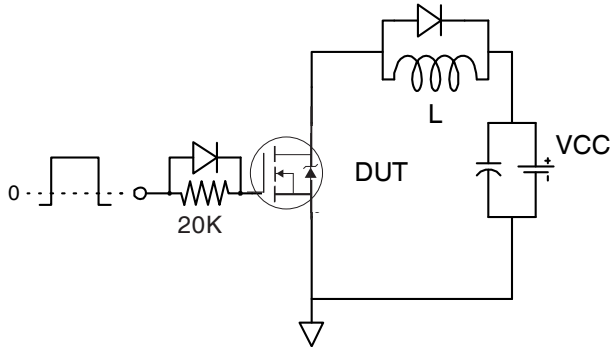

Fig 19a. Gate Charge Test Circuit

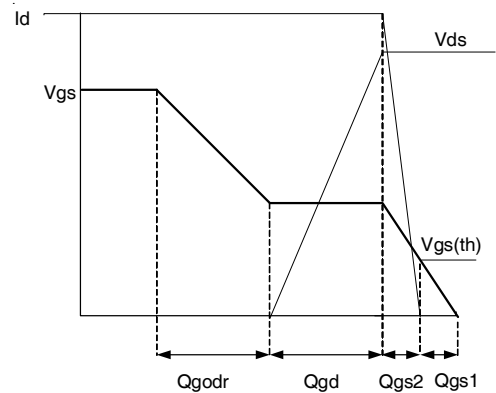

Fig 19b. Gate Charge Waveform

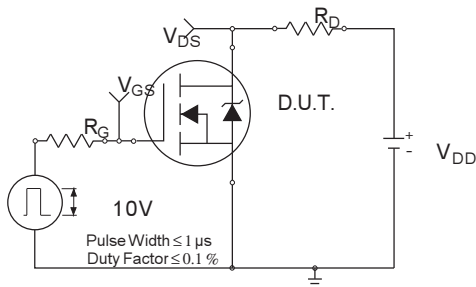

Fig 20a. Switching Time Test Circuit

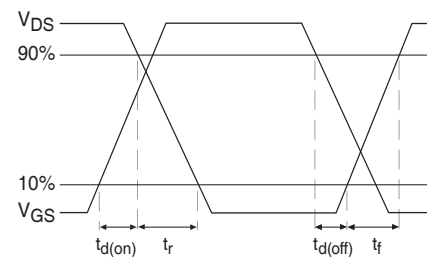

Fig 20b. Switching Time Waveforms

Notes on Repetitive Avalanche Curves , Figures 16, 17:
(For further info, see AN-1005 at www.irf.com)

1. Avalanche failures assumption:
Purely a thermal phenomenon and failure occurs at a temperature far in excess of T_{jmax} . This is validated for every part type.
2. Safe operation in Avalanche is allowed as long as T_{jmax} is not exceeded.
3. Equation below based on circuit and waveforms shown in Figures 18a, 18b.
4. $P_{D(ave)}$ = Average power dissipation per single avalanche pulse.
5. BV = Rated breakdown voltage (1.3 factor accounts for voltage increase during avalanche).
6. I_{av} = Allowable avalanche current.
7. ΔT = Allowable rise in junction temperature, not to exceed T_{jmax} (assumed as 25°C in Figure 16, 17).
 t_{av} = Average time in avalanche.
 D = Duty cycle in avalanche = $t_{av} \cdot f$
 $Z_{thJC}(D, t_{av})$ = Transient thermal resistance, see figure 15)

DirectFET® Board Footprint, M2 (Medium Size Can).

Please see AN-1035 for DirectFET® assembly details and stencil and substrate design recommendations

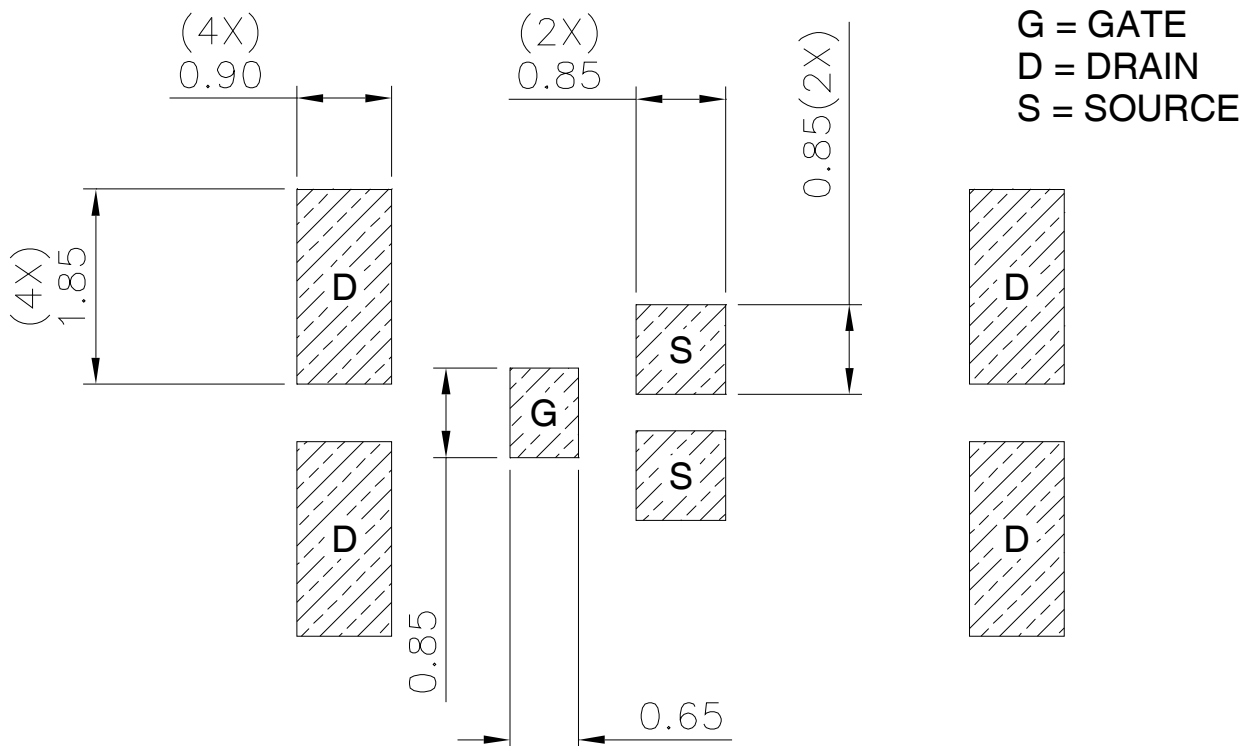
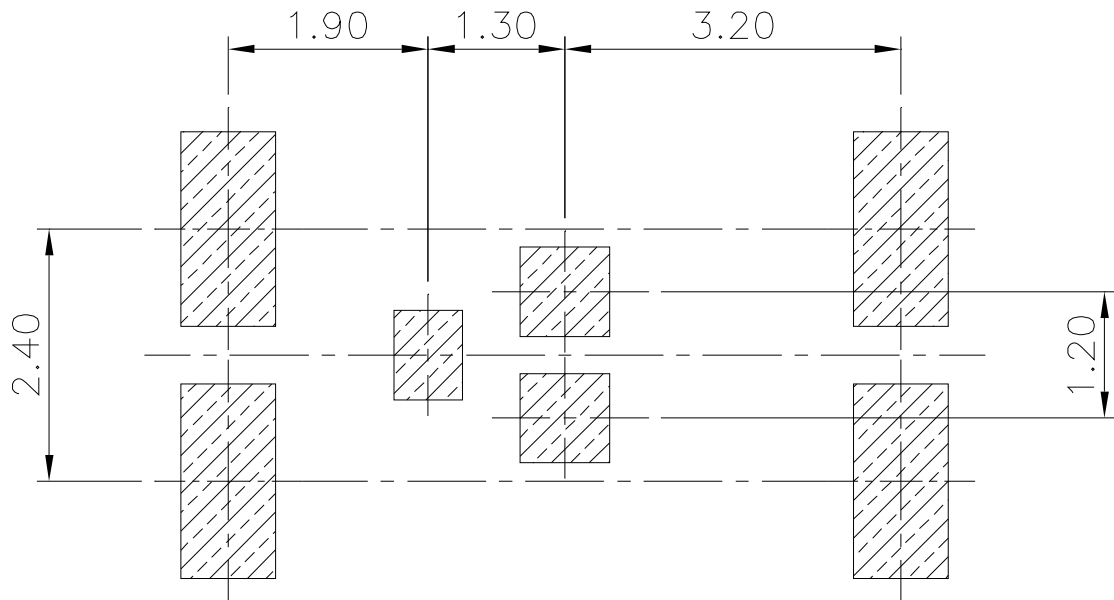

DirectFET® Outline Dimension, M2 Outline (Medium Size Can, 2-Source Pads).
 Please see AN-1035 for DirectFET® assembly details and stencil and substrate design recommendations

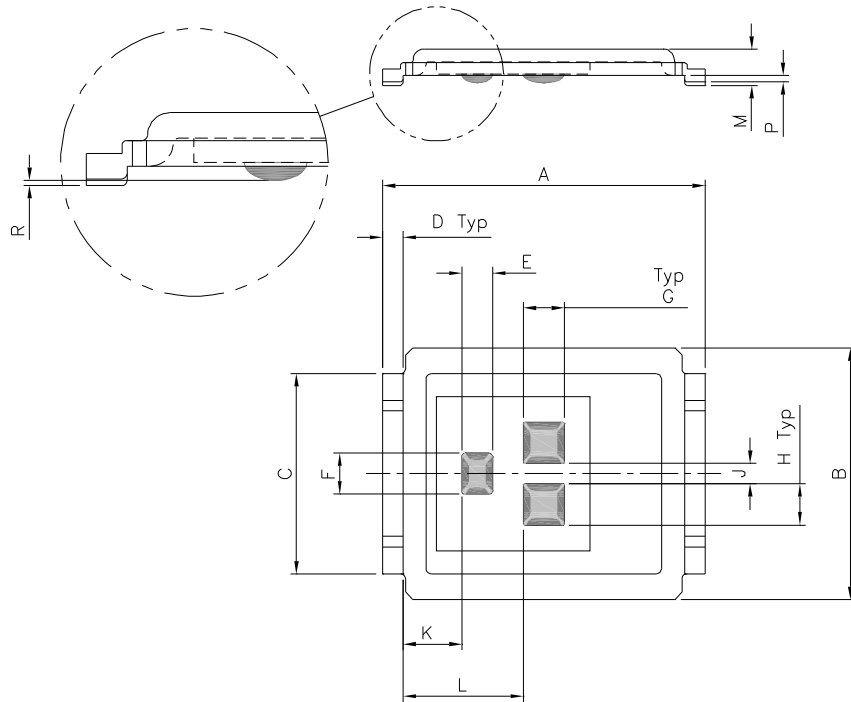

DIMENSIONS				
CODE	METRIC		IMPERIAL	
	MIN	MAX	MIN	MAX
A	6.25	6.35	0.246	0.250
B	4.80	5.05	0.189	0.199
C	3.85	3.95	0.152	0.156
D	0.35	0.45	0.014	0.018
E	0.58	0.62	0.023	0.024
F	0.78	0.82	0.031	0.032
G	0.78	0.82	0.031	0.032
H	0.78	0.82	0.031	0.032
I	N/A	N/A	N/A	N/A
J	0.38	0.42	0.015	0.017
K	1.10	1.20	0.043	0.047
L	2.30	2.40	0.090	0.094
M	0.68	0.74	0.027	0.029
P	0.09	0.17	0.003	0.007
R	0.02	0.08	0.001	0.003

DirectFET® Part Marking

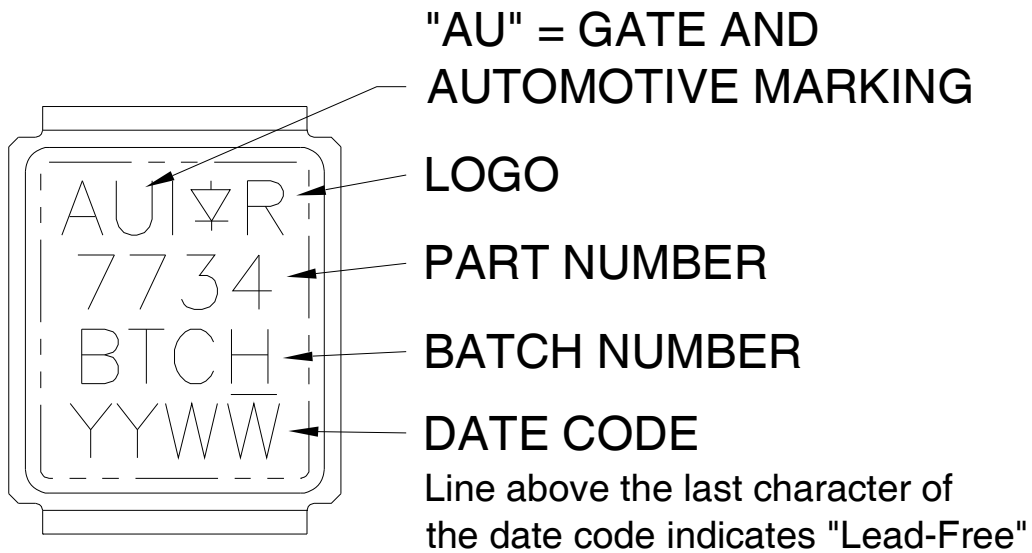

Note: For the most current drawing please refer to IR website at <http://www.irf.com/package/>

DirectFET® Tape & Reel Dimension (Showing component orientation).

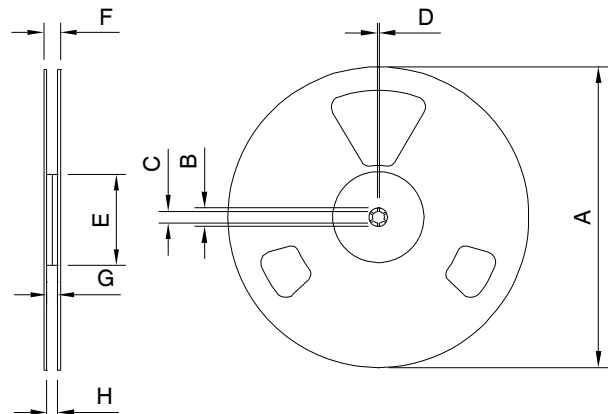
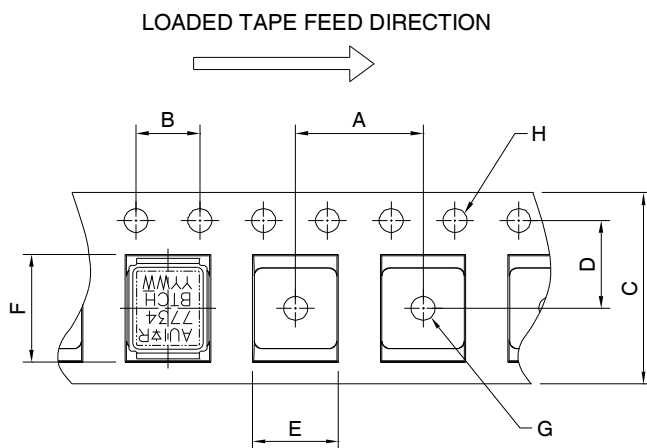

NOTE: Controlling dimensions in mm
Std reel quantity is 4800 parts. (ordered as AUIRF7734M2TR). For 1000 parts on 7" reel, order AUIRF7734M2TR1

NOTE: CONTROLLING DIMENSIONS IN MM

CODE	METRIC		IMPERIAL	
	MIN	MAX	MIN	MAX
A	7.90	8.10	0.311	0.319
B	3.90	4.10	0.154	0.161
C	11.90	12.30	0.469	0.484
D	5.45	5.55	0.215	0.219
E	5.10	5.30	0.201	0.209
F	6.50	6.70	0.256	0.264
G	1.50	N.C	0.059	N.C
H	1.50	1.60	0.059	0.063

CODE	REEL DIMENSIONS							
	STANDARD OPTION (QTY 4800)				TR1 OPTION (QTY 1000)			
	METRIC		IMPERIAL		METRIC		IMPERIAL	
A	330.0	N.C	12.992	N.C	177.77	N.C	6.9	N.C
B	20.2	N.C	0.795	N.C	19.06	N.C	0.75	N.C
C	12.8	13.2	0.504	0.520	13.5	12.8	0.53	0.50
D	1.5	N.C	0.059	N.C	1.5	N.C	0.059	N.C
E	100.0	N.C	3.937	N.C	58.72	N.C	2.31	N.C
F	N.C	18.4	N.C	0.724	N.C	13.50	N.C	0.53
G	12.4	14.4	0.488	0.567	11.9	12.01	0.47	N.C
H	11.9	15.4	0.469	0.606	11.9	12.01	0.47	N.C

Notes:

- ① Click on this section to link to the appropriate technical paper.
- ② Click on this section to link to the DirectFET® Website.
- ③ Surface mounted on 1 in. square Cu board, steady state.
- ④ T_C measured with thermocouple mounted to top (Drain) of part.
- ⑤ Repetitive rating; pulse width limited by max. junction temperature.
- ⑥ Starting $T_J = 25^\circ\text{C}$, $L = 0.06\text{mH}$, $R_G = 50\Omega$, $I_{AS} = 43\text{A}$, $V_{GS} = 20\text{V}$.
- ⑦ Pulse width $\leq 400\mu\text{s}$; duty cycle $\leq 2\%$.
- ⑧ Used double sided cooling, mounting pad with large heatsink.
- ⑨ Mounted on minimum footprint full size board with metalized back and with small clip heatsink.
- ⑩ R_θ is measured at T_J of approximately 90°C .

IMPORTANT NOTICE

Unless specifically designated for the automotive market, International Rectifier Corporation and its subsidiaries (IR) reserve the right to make corrections, modifications, enhancements, improvements, and other changes to its products and services at any time and to discontinue any product or services without notice. Part numbers designated with the "AU" prefix follow automotive industry and / or customer specific requirements with regards to product discontinuance and process change notification. All products are sold subject to IR's terms and conditions of sale supplied at the time of order acknowledgment.

IR warrants performance of its hardware products to the specifications applicable at the time of sale in accordance with IR's standard warranty. Testing and other quality control techniques are used to the extent IR deems necessary to support this warranty. Except where mandated by government requirements, testing of all parameters of each product is not necessarily performed.

IR assumes no liability for applications assistance or customer product design. Customers are responsible for their products and applications using IR components. To minimize the risks with customer products and applications, customers should provide adequate design and operating safeguards.

Reproduction of IR information in IR data books or data sheets is permissible only if reproduction is without alteration and is accompanied by all associated warranties, conditions, limitations, and notices. Reproduction of this information with alterations is an unfair and deceptive business practice. IR is not responsible or liable for such altered documentation. Information of third parties may be subject to additional restrictions.

Resale of IR products or serviced with statements different from or beyond the parameters stated by IR for that product or service voids all express and any implied warranties for the associated IR product or service and is an unfair and deceptive business practice. IR is not responsible or liable for any such statements.

IR products are not designed, intended, or authorized for use as components in systems intended for surgical implant into the body, or in other applications intended to support or sustain life, or in any other application in which the failure of the IR product could create a situation where personal injury or death may occur. Should Buyer purchase or use IR products for any such unintended or unauthorized application, Buyer shall indemnify and hold International Rectifier and its officers, employees, subsidiaries, affiliates, and distributors harmless against all claims, costs, damages, and expenses, and reasonable attorney fees arising out of, directly or indirectly, any claim of personal injury or death associated with such unintended or unauthorized use, even if such claim alleges that IR was negligent regarding the design or manufacture of the product.

Only products certified as military grade by the Defense Logistics Agency (DLA) of the US Department of Defense, are designed and manufactured to meet DLA military specifications required by certain military, aerospace or other applications. Buyers acknowledge and agree that any use of IR products not certified by DLA as military-grade, in applications requiring military grade products, is solely at the Buyer's own risk and that they are solely responsible for compliance with all legal and regulatory requirements in connection with such use.

IR products are neither designed nor intended for use in automotive applications or environments unless the specific IR products are designated by IR as compliant with ISO/TS 16949 requirements and bear a part number including the designation "AU". Buyers acknowledge and agree that, if they use any non-designated products in automotive applications, IR will not be responsible for any failure to meet such requirements.

For technical support, please contact IR's Technical Assistance Center
<http://www.irf.com/technical-info/>

WORLD HEADQUARTERS:

101 N. Sepulveda Blvd., El Segundo, California 90245
Tel: (310) 252-7105