

TVS/ESD Arrays

RLSD12AxxxC Series

TVS/ESD Arrays - RLSD12AxxxC Series

Features

- 350 Watts peak pulse power ($t_p = 8/20\mu s$)
- Transient protection for data lines to
IEC 61000-4-2 (ESD) $\pm 15kV$ (air), $\pm 8kV$ (contact)
IEC 61000-4-4 (EFT) 40A (5/50ns)
IEC 61000-4-5 (Lightning) 24A (8/20 μs)
- Small package for use in portable electronics
- Suitable replacement for MLV's in ESD protection applications
- Protects one I/O or power line
- Solid-state silicon avalanche technology



Mechanical Characteristics

- SOD-123 package
- Molding compound flammability rating: UL 94V-0
- Packaging: Tape and Reel per EIA 481
- Lead Finish: Matte tin
- RoHS Compliant

Applications

- Personal digital assistants (PDA)
- Cellular handsets & Accessories
- Portable devices
- Portable instrumentation
- Handhelds and notebooks
- Digital cameras

Life Support Note

- Not Intended for Use in Life Support or Life Saving Applications
- The products shown herein are not designed for use in life sustaining or life saving applications unless otherwise expressly indicated

Pinout and Functional Block Diagram

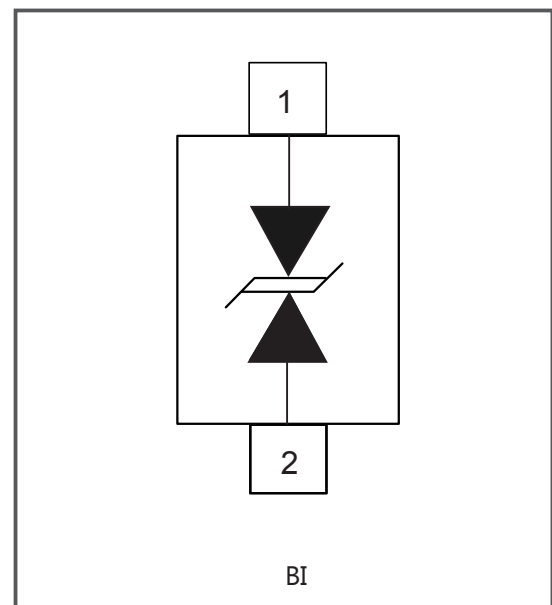

TVS/ESD Arrays - RLSD12AxxxC Series

Absolute Maximum Rating

Rating	Symbol	Value	Units
Peak pulse power (tp=8/20µs waveform)	Ppp	200	Watts
ESD voltage (HBM contact)	VESD	±25	Kv
operating temperature range	TJ	-55 to +125	°C
Storage temperature range	TSTG	-55 to +150	°C

Electrical Characteristics Per Lin (@ 25°C Unless Otherwise Specified)

Type Number	Peak Power Dissipation @8/20µS Pppm	Reverse Stand-Off Voltage Vrwm Max	Peak Pulse Voltage @8/20µS Pppm Vc@IPP	Peak Pulse Current @8/20µS Pppm IPP	Reverse Leakage @Vrwm IR@Vrwm Max	Maximum Capacitance @1MHZ Co Max
	W	V	V	A	µA	pF
RLSD12A051C	400	5	7.5	5	20	235
RLSD12A121C	400	12	14.5	5	1	185
RLSD12A151C	400	15	19	5	1	165
RLSD12A241C	400	24	29	5	1	120

TVS/ESD Arrays - RLSD12AxxxC Series

Typical Characteristics

Figure 1. Peak Pulse Power Rating Curve

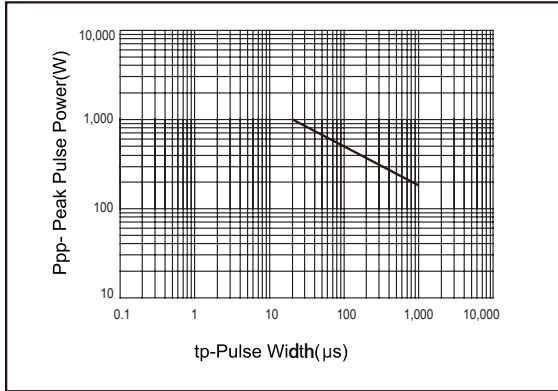

Figure 2. 10/1000 μs Pulse Waveforms

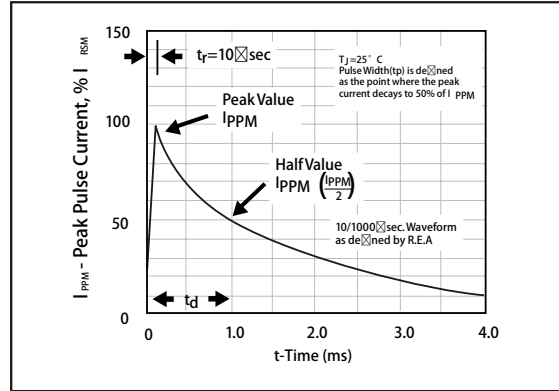

Figure 3. 8/20 μs Pulse Waveforms

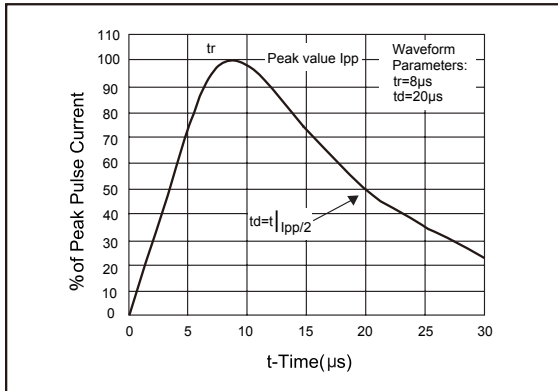

Figure 4. Power Derating Curve

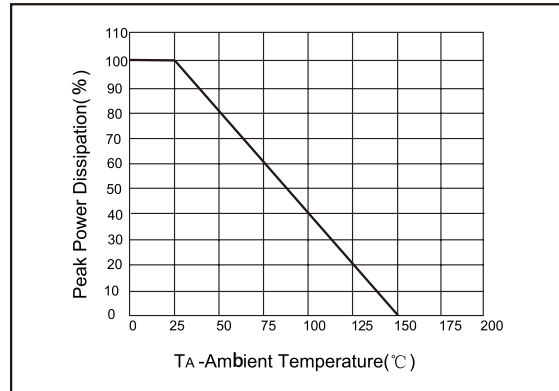
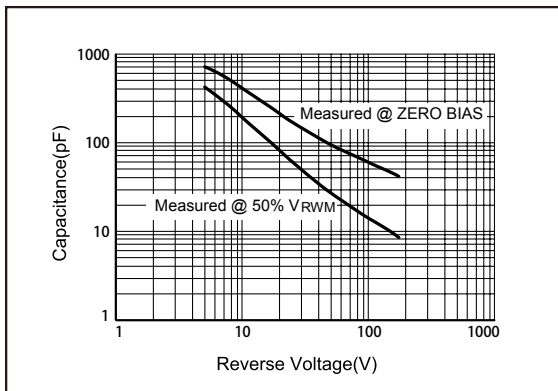
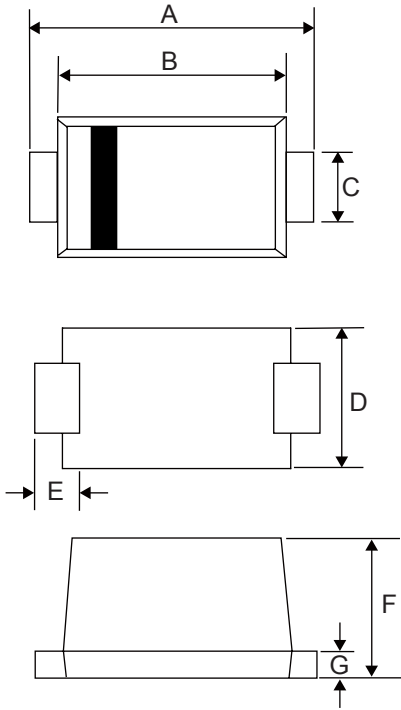

Figure 5. Capacitance vs. Reverse Voltage



TVS/ESD Arrays - RLSD12AxxxC Series

Package dimension SOD-123



Dimensions				
Symbol	Inches		Millimeters	
	Min	Max	Min	Max
A	0.138	0.154	3.50	3.90
B	0.102	0.118	2.60	3.00
C	0.030	0.037	0.75	0.95
D	0.063	0.079	1.60	2.00
E	0.031typ		0.80typ	
F	0.035	0.039	0.90	1.05
G	0.007	0.009	0.18	0.22

Soldering footprint

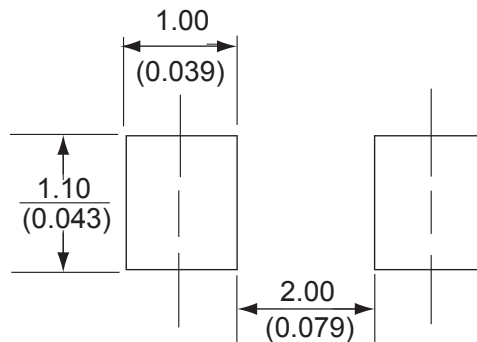

TVS/ESD Arrays - RLSD12AxxxC Series

Part Number Code

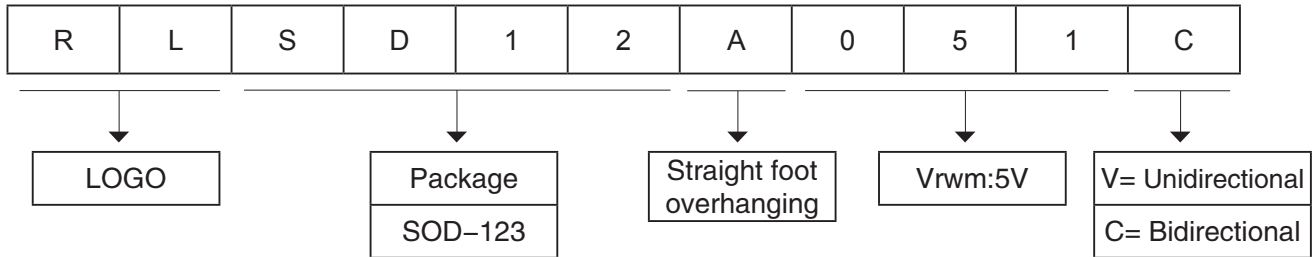

Tape and reel

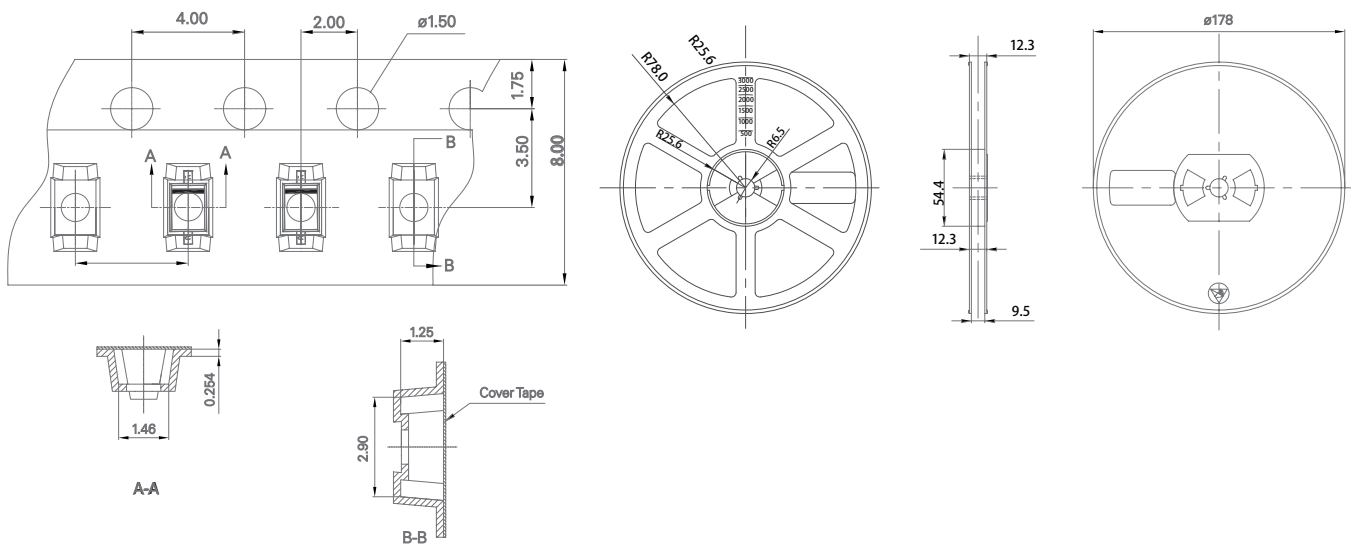

Ordering Information

Part Number	Package	Min. Order Qty.
RLSD12AxxxC	SOD-123	3000pcs

Warehouse Storage Conditions of Products

- Storage Conditions:
- 1. Storage Temperature: -10°C~+40°C
- 2. Relative Humidity: ≤75%RH
- 3. Keep away from corrosive atmosphere and sunlight.
- 4. Period of Storage: 1 year

RuiLongYuan Electronics Co., Ltd.

- Reproducing and modifying information of the document is prohibited without permission from Ruilongyuan International Inc.
- Ruilongyuan International Inc. reserves the rights to make changes of the content herein the document anytime without notification. Please refer to our website for the latest document.
- Ruilongyuan International Inc. disclaims any and all liability arising out of the application or use of any product including damages incidentally and consequentially occurred.
- Ruilongyuan International Inc. does not assume any and all implied warranties, including warranties of fitness for particular purpose, non-infringement and merchantability.
- Applications shown on the herein document are examples of standard use and operation. Customers are responsible in comprehending the suitable use in particular applications. Ruilongyuan International Inc. makes no representation or warranty that such applications will be suitable for the specified use without further testing or modification.
- The products shown herein are not designed and authorized for equipments requiring high level of reliability or relating to human life and for any applications concerning life-saving or life-sustaining, such as medical instruments, transportation equipment, aerospace machinery et cetera. Customers using or selling these products for use in such applications do so at their own risk and agree to fully indemnify Ruilongyuan International Inc. for any damages resulting from such improper use or sale.

Tel: +86-755-8290 8296

Fax: +86-755-8290 8002

E-mail: jack@ruilon.com