

# GOLDFISH

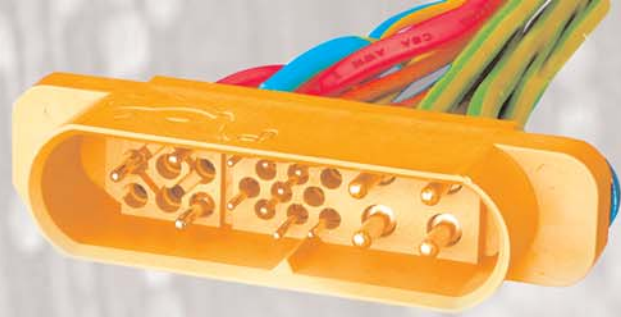

## Power Connectors

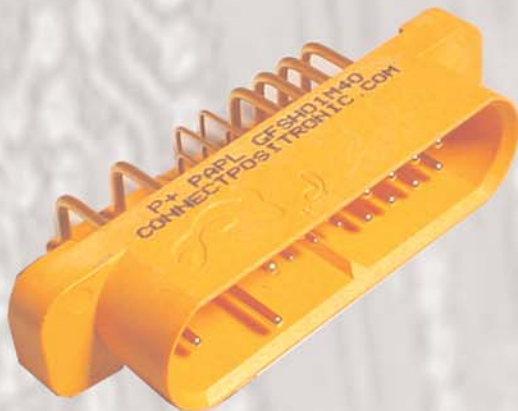
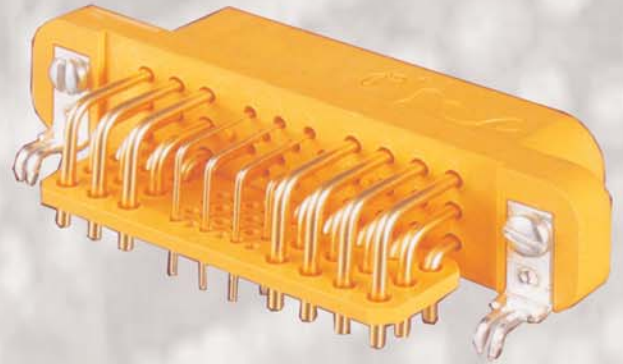

## Positronic Industries

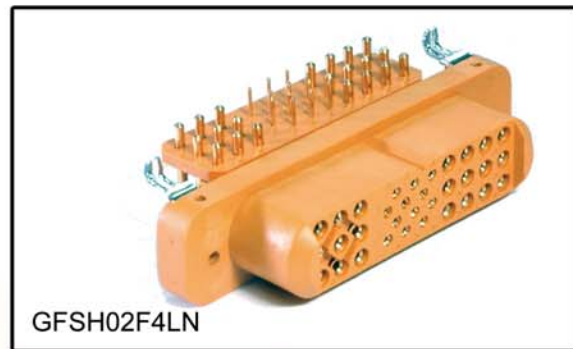
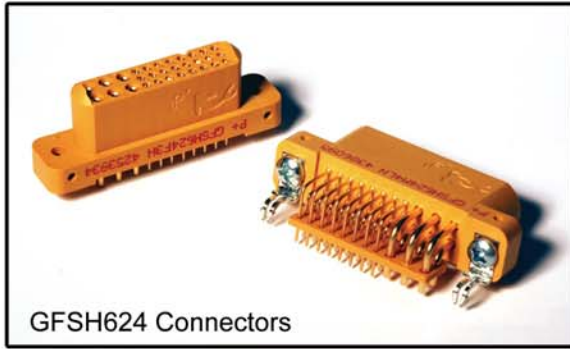

## GoldFish Power Connectors Feature!!!

- **Excellent Power Density**
- **Blind mate - Float mounting**
- **20, 35 and 50 ampere power contacts**
- **Hot Plug Capability**
- **AC, DC and Signal contacts in one connector**
- **Safety Agency Recognition**

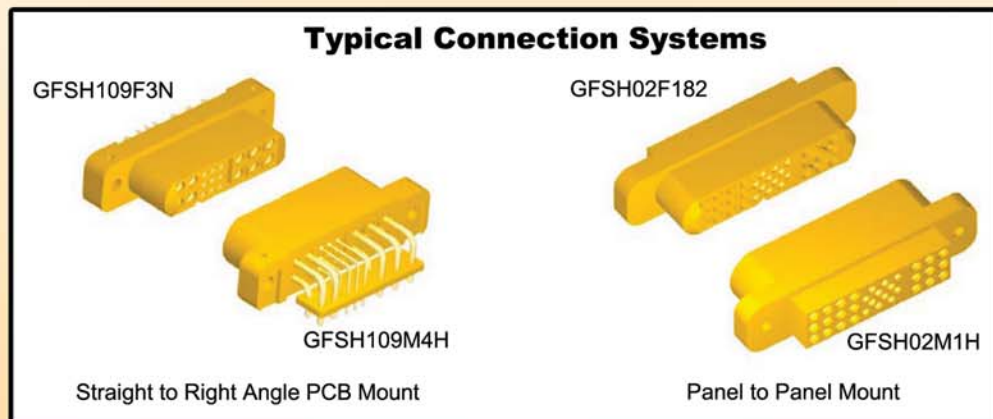

Unless otherwise specified, dimensional tolerances are:

- 1) Male contact mating diameters :  $\pm 0.03$  [0.001]
- 2) Contact termination diameters :  $\pm 0.08$  [0.003]
- 3) All diameters :  $\pm 0.13$  [0.005]
- 4) All other dimensions :  $\pm 0.38$  [0.015]

All dimensions are in millimeters [inches]

Unless otherwise stated, Positronic code and part number are marked on each connector. The contents of the code are subjected to the discretion of Positronic Asia Pte Ltd and it is for internal use only. Marking may be done on either side or both sides of the connector.

Positronic Asia Pte Ltd believes the data contained herein to be reliable. Since the technical information is given free of charge, the user employs such information at his own discretion and risk. Positronic Asia Pte Ltd assumes no responsibility for results obtained or damages incurred from use of such information in whole or in part.

CATALOG NO: A-001 Rev. A

## Goldfish Power Connectors

### Connector versions and technical characteristics



### Connector Versions

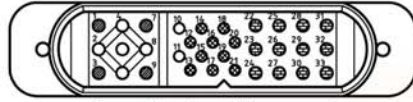

Size 16 AC Power    Size 20 Signal    Size 16 DC Power

**GFSH01:** Partially populated connector  
 Number of size 16 power contacts: 16  
 Number of size 20 signal contacts: 10  
 Positions 7 & 9 of male connector are first mate contacts.

**GFSH02:** Fully populated connector  
 Number of size 16 power contacts: 21  
 Number of size 20 signal contacts: 12  
 (Same connector body as GFSH01.)



**GFSH109:** Fully populated connector  
 Number of size 16 power contacts: 10  
 Number of size 22 signal contacts: 9

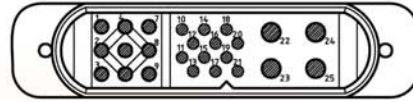

**GFSH435:** Fully populated connector  
 Number of size 12 power contacts: 4  
 Number of size 16 power contacts: 9  
 Number of size 20 signal contacts: 12



**GFSH928:** Fully populated connector  
 Number of size 16 power contacts: 18  
 Number of size 22 signal contacts: 28



**GFSH624:** Fully populated connector  
 Number of size 16 power contacts: 6  
 Number of size 22 signal contacts: 24

### Technical Characteristics

#### Materials and Finishes

Insulator: Glass-filled nylon, UL 94V-0.  
 Contacts: Precision machined copper alloy with gold over nickel plate.

#### Electrical Characteristics

##### Contact Current Ratings

Size 12 Contacts: 35 amperes, continuous.  
 50 amperes, continuous (super conductive material).  
 Size 16 Contacts: 20 amperes, continuous.  
 Size 20 Contacts: 5 amperes, nominal.  
 Size 22 Contacts: 3 amperes, nominal.

##### Initial Contact Resistance (max.) per IEC 512-2, Test 2b.

Size 12 Contacts: 0.0007 ohms (super conductive material).  
 Size 12 Contacts: 0.001 ohms.  
 Size 16 Contacts: 0.003 ohms.  
 Size 20/22 Contacts: 0.005 ohms.

Insulator Resistance: 5 G ohms min. per IEC 512-2, Test 3a.

##### Proof Voltage

Power Contacts: 1500 V r.m.s.  
 Signal Contacts: 1000 V r.m.s.

##### Working Voltage

Power Contacts: 500 V r.m.s.  
 Signal Contacts: 333 V r.m.s.

##### Hot Pluggable (50 couplings per UL 1977, paragraph 15)

Size 12 Contacts: 250 VAC at 25 amperes.  
 Size 16 Contacts: Consult factory.

#### Mechanical Characteristics

Blind Mating System: Molded in guides allow for misalignment up to 2.00 mm [0.079 inch].

Polarization: Provided by insulator.

Removable Contacts: Install contact from rear of insulator; release with extraction tool from front of insulator. Female contacts feature "closed entry" 1,000 cycles design.

Fixed Contacts: Size 12 and 16 female contacts feature "closed entry" 1,000 cycles design (for both straight & right angle (90°) PCB mount).

##### Contact Retention in insulator (removable and fixed)

Power Contacts: 45 N [10 lbs.] min.  
 Signal Contacts: 27 N [6 lbs.] min.

Sequential Mating: Two and three level systems available. Consult factory for customization.

#### Climatic Characteristics

Working temperature: -55° to +125°C.

#### Recognized

UL: File E49351

TÜV: File 006089

For TÜV, first mate contact is not designed for use as protective earthing terminal.



## Contact Sizes

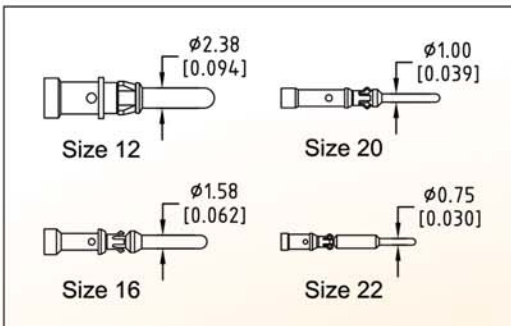

## Sequential Mating Systems

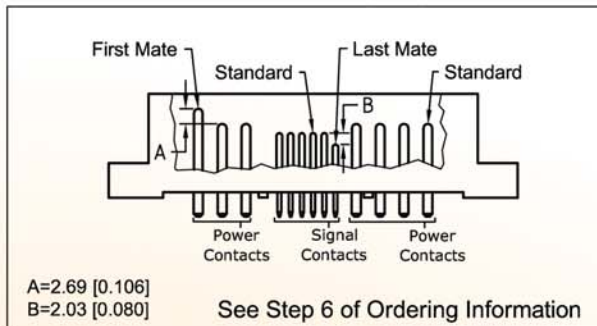

## Temperature Rise Curves

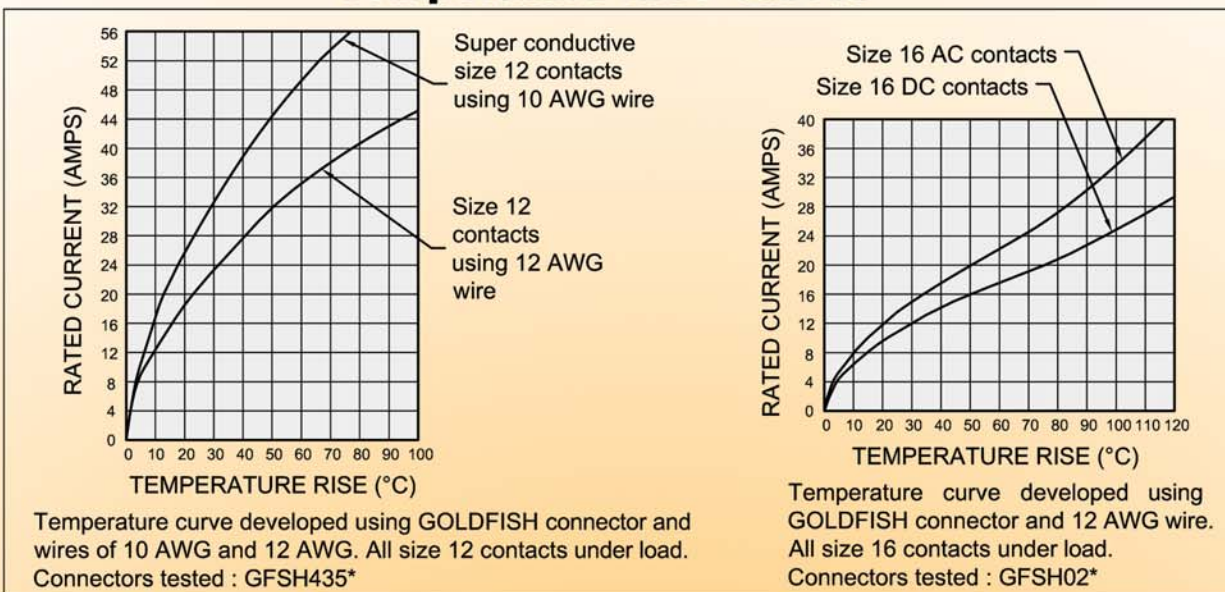

Tested per IEC Publication 512-3, Test 5a

## 1,000 CYCLES CONTACT PERFORMANCE

### CONTACT RESISTANCE - DURING CYCLE TESTING AND HUMIDITY CONDITIONING

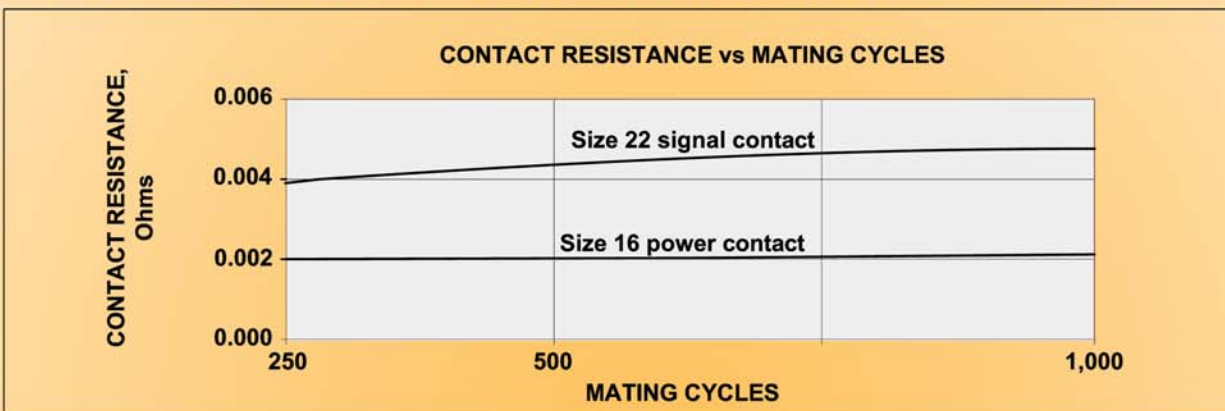

Humidity condition per EIA-364-31B, Method II (condition A) after 250, 500 and 1,000 cycles.  
 Contact resistance per IEC 512-2, Test 2b. Connectors tested : GFSH624\*

## Straight and Right Angle (90°) PCB Mount Connectors Goldfish Versions 01, 02, 435 and 928



### Outline Dimensions

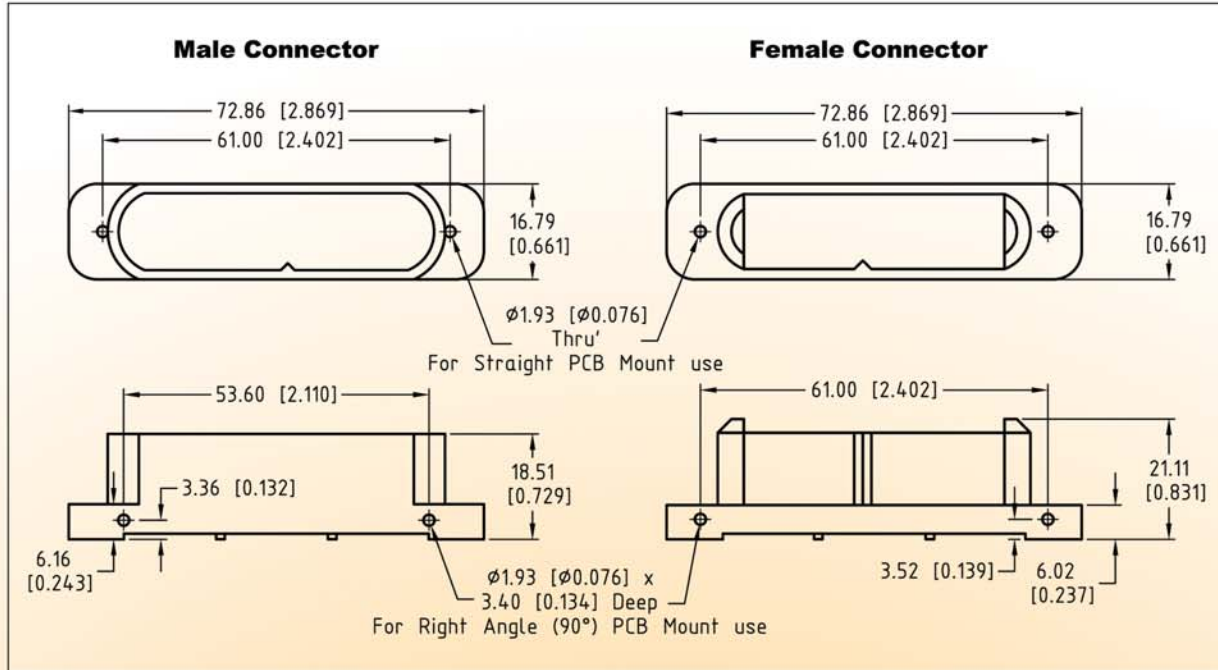

### Contact Termination Dimensions See Step 4 of Ordering Information

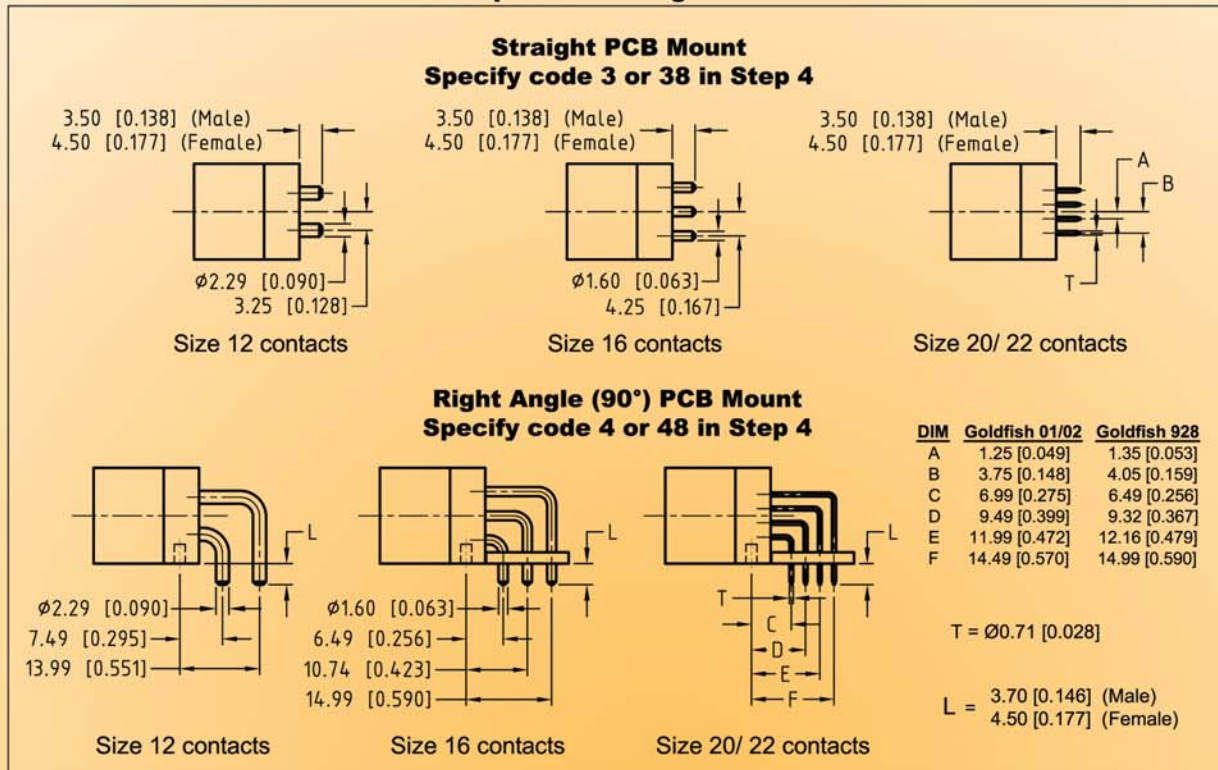

Connector shown is male. Unless otherwise specified, above dimensions are identical to female connector.

## Straight and Right Angle (90°) PCB Mount Connectors Baby Goldfish Versions 109 and 624



### Outline Dimensions

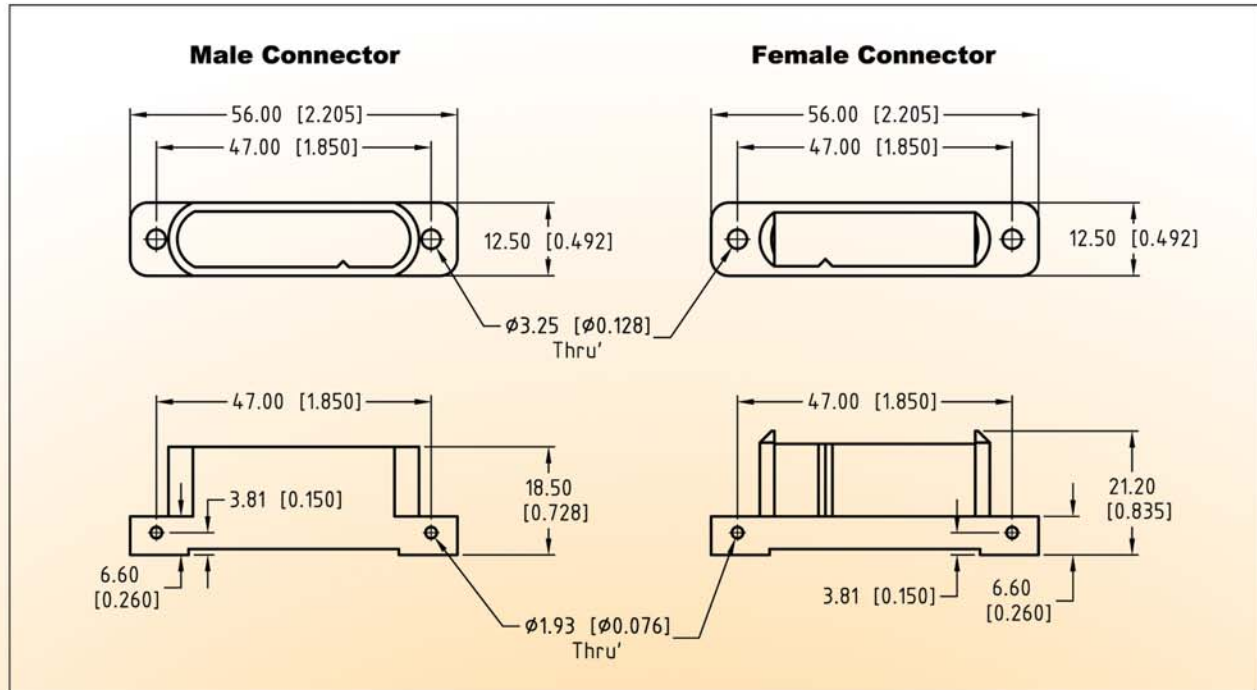

### Contact Termination Dimensions See Step 4 of Ordering Information

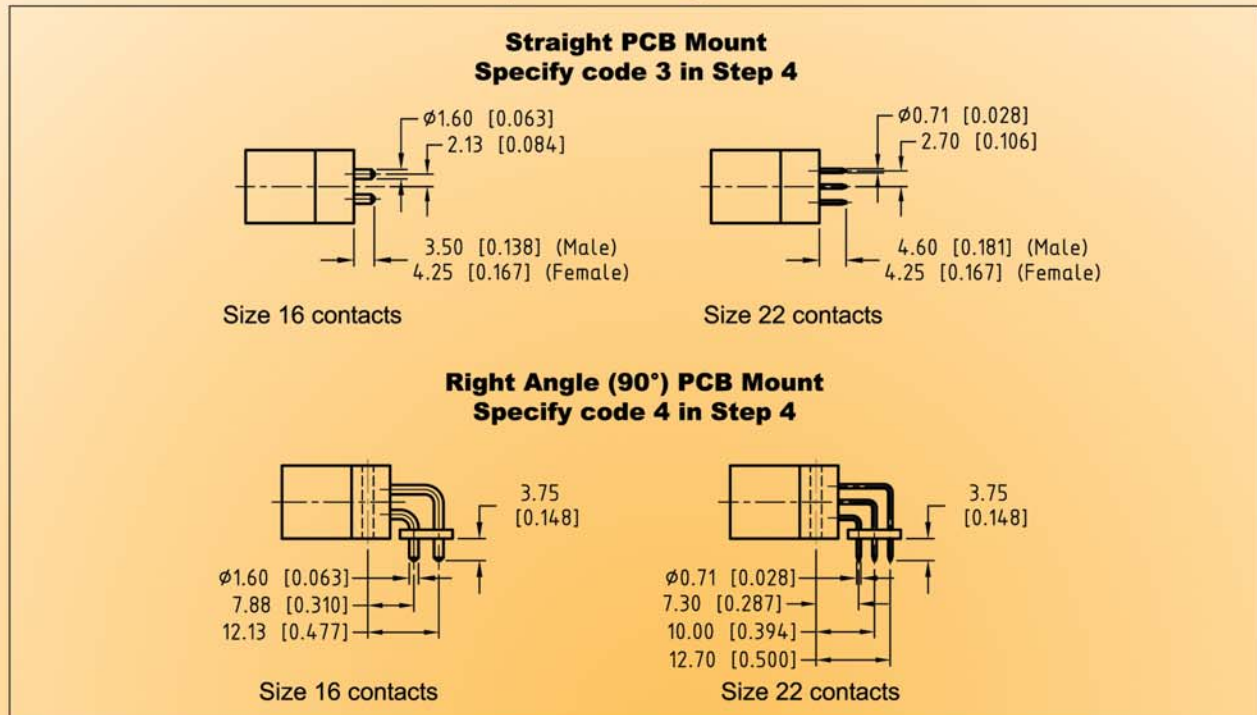

Connector shown is male. Unless otherwise specified, above dimensions are identical to female connector.



### Outline Dimensions

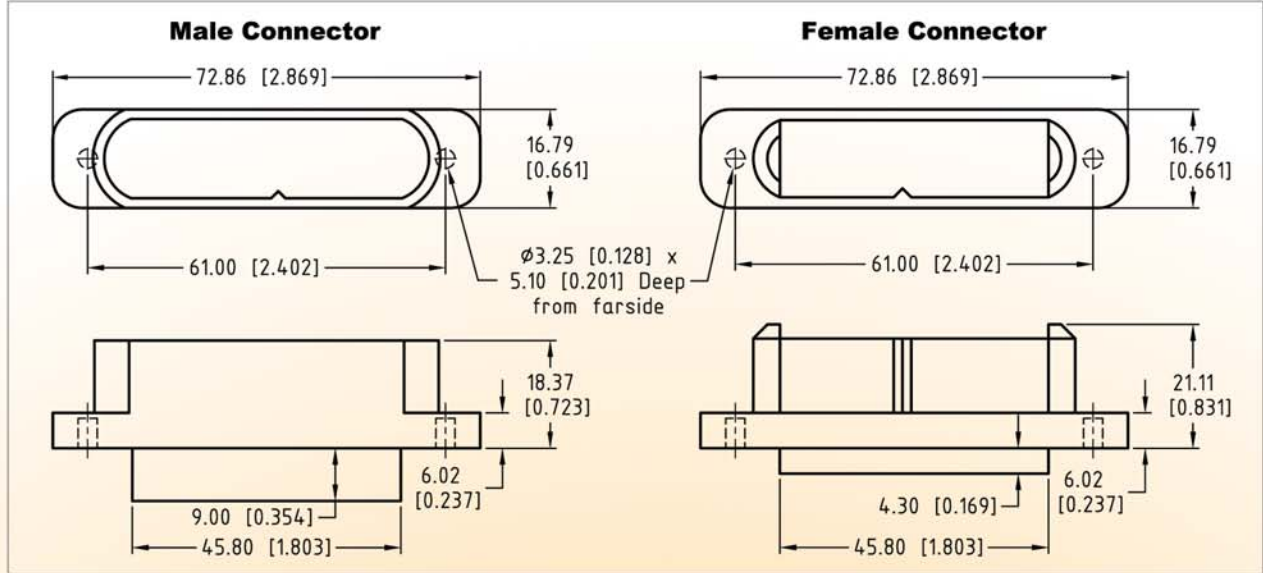

### Baby Goldfish Versions 109 and 624

Specify code 1 in Step 4 of Ordering Information

### Outline Dimensions

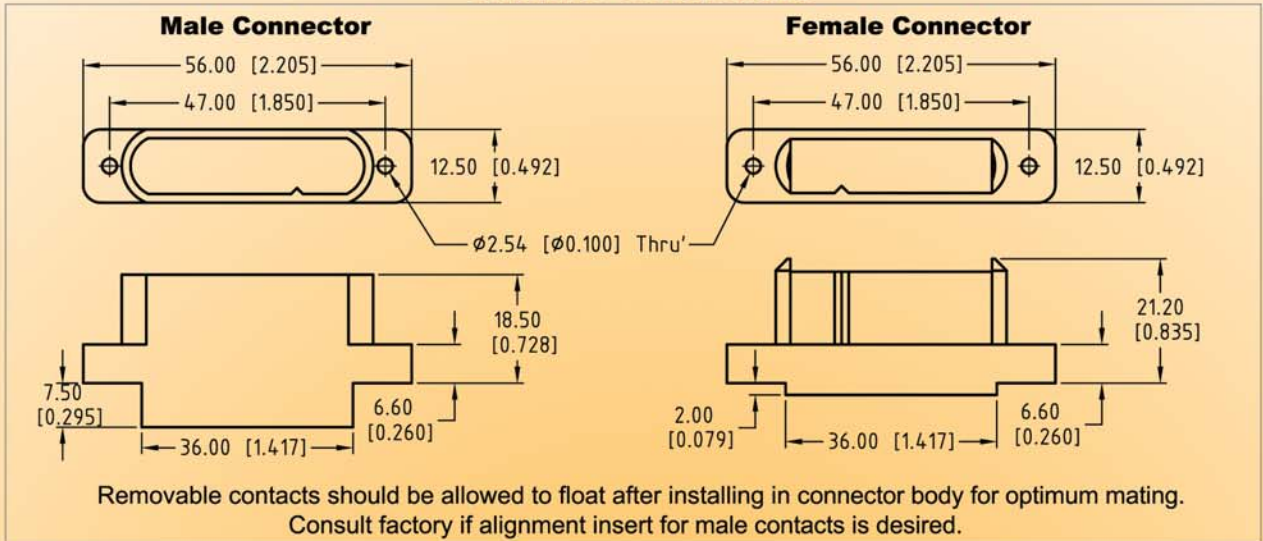

### Panel Cutout Dimensions (for Float Mount Connectors)

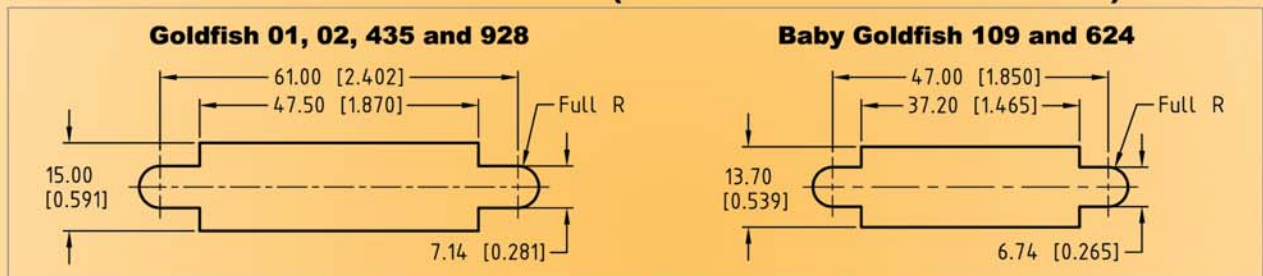

## Compliant Press-Fit Terminations

See Step 4 of Ordering Information

### PCB Straight Mount



#### Contact Termination Dimensions

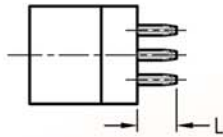

Bi-Spring Power  
size 16 contacts  
per IEC 60352-5

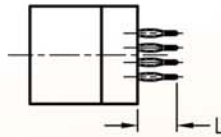

Omega Signal  
size 20/ 22 contacts  
Patent No. 6,260,268

Specify code 93 or 94 in Step 4.



Order

Code	"L" Length	PCB Thickness
93	5.72 [0.225]	2.29 to 4.45 [0.090 to 0.175]
94	7.04 [0.277]	4.45 [0.175] min.

Connector shown is male. Unless otherwise specified, above dimensions are identical to female connector.

Note: Outline dimensions for Press-Fit Connectors are the same as those of Straight PCB Mount Versions.

#### Press-Fit User Information

##### Connectors-to-PCB installation instructions:

1. Choose the proper tooling. Insertion tooling and single contact repair tooling are available from Positronic.
2. Insert the connector into the PCB or backplane and seat connector fully with seating/ support tool.
3. Secure the connector to the PCB or backplane using two self-tapping screws for plastic.

##### Need to repair a single contact because of damage in manufacturing, testing, or field use?

1. Choose the proper contact extraction tool.
2. Push the contact out with a firm, steady force. Remember, excessive force is not required.
3. Install a new contact with the proper contact insertion tool. You are done.

#### Mounting Screws Ordering Information

Connector Variant	Screw Part No.
GFSH01/02/928* 1 H	2076-12-6-16
GFSH01/02/928* 3 H	4546- 7 -1-16
GFSH01/02/928* 4 H	4546- 7 -0-16
GFSH01/02/928*93H	4546- 7 -2-16
GFSH01/02/928*94H	4546- 7 -3-16
GFSH109/624* 1 H	2076-16-1-16
GFSH109/624* 3 H	2076-12-6-16
GFSH109/624* 4 H	4546- 7 -0-16
GFSH109/624*93H	2076-12-6-16
GFSH109/624*94H	2076-12-0-16
GFSH435* 1 H	2076-12-6-16
GFSH435* 3 H	4546- 7 -1-16
GFSH435* 4 H	4546- 7 -0-16
GFSH435*38H	4546- 7 -1-16
GFSH435*48H	4546- 7 -0-16

Material: Steel with Zinc plating

#### Contact Hole Patterns

as per PCB straight mount  
suggested PCB hole sizes

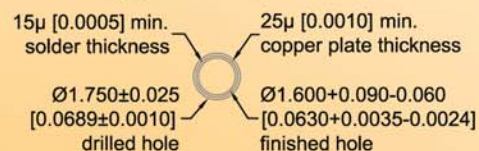

Size 16 Press-Fit Contact Hole

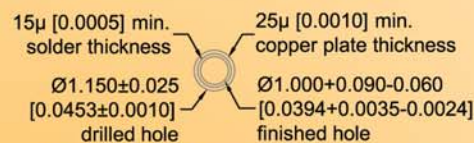

Size 20/ 22 Press-Fit Contact Hole

Consult factory for optional platings

#### Single Contact Insertion/ Extraction Tools Ordering Information

Contact Size	Insertion Tool Part No.	Extraction Tool Part No.
Size 16	Male 9513-100-0-0	9513-102-0-0
	Female 9513-101-0-0	
Size 20	Male 9512-100-0-0	9512-102-0-0
	Female 9512-101-0-0	
Size 22	Male 9512-103-0-0	9512-105-0-0
	Female 9512-104-0-0	

#### Connector Installation Tools Ordering Information

Connector Variant	Seating Tool Part No.	Support Tool Part No.
GFSH01M93/94H	9513-309-1-0	9513-404-1-0
GFSH02M93/94H	9513-309-2-0	
GFSH02F93/94H	9513-309-3-0	

Consult factory for other connector variants.



## Mounting Styles and Contact Hole Patterns for PCB Mount



Right Angle (90°) Mounting Brackets		Push-on Fastener	Float Mounting Hardware
Through Hole (B)	With Board Lock (LN)	"A"	"B"
Specify code B or LN.		Specify code N.	Specify code 82 or 83.
Material: Brass with Zinc and Tin plating respectively		Material: Copper Alloy with Tin plating	Material: Steel with Zinc plating

Goldfish	"A"	Code	Goldfish	"B"
02/435	3.17 [0.124]	82	02/435/928	2.00 [0.078]
109/624	3.42 [0.134]	82	109/624	2.13 [0.083]
928	3.37 [0.132]	83	02/435/928	2.70 [0.106]
		83	109/624	2.84 [0.111]

### Contact Hole Patterns for Straight PCB Mount

#### Goldfish 01 and 02 Straight PCB Mount

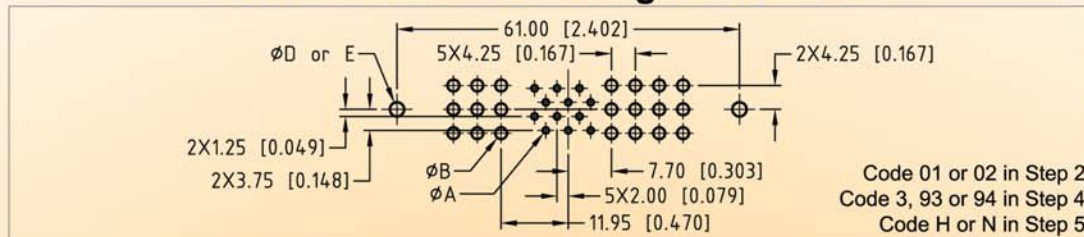

#### Goldfish 435 Straight PCB Mount

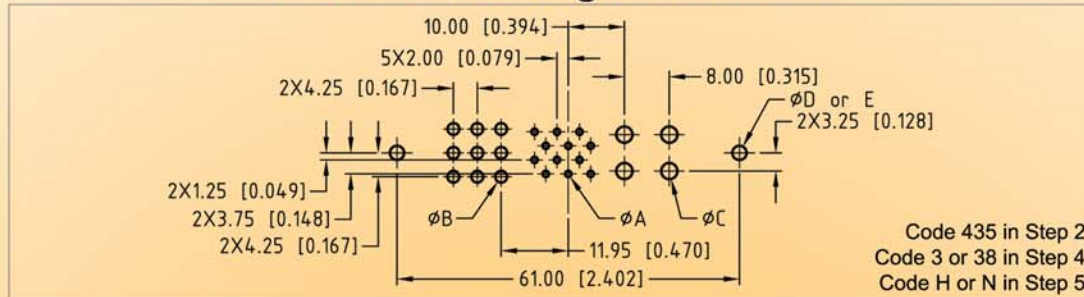

#### Goldfish 928 Straight PCB Mount

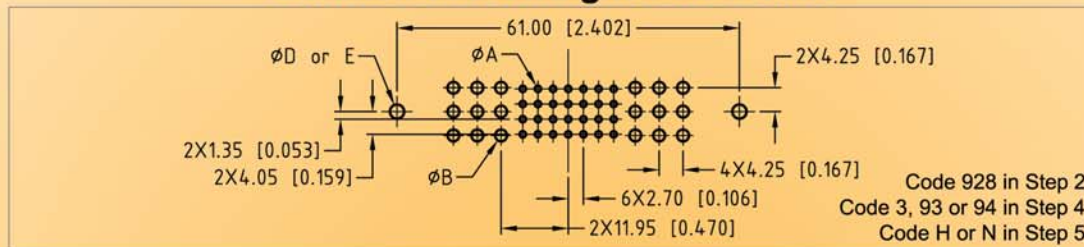

DIM	Suggested size	For use
A	Ø1.14 [0.045]	Size 20 & 22 contact terminals
B	Ø2.11 [0.083]	Size 16 contact terminals
C	Ø2.90 [0.114]	Size 12 contact terminals
(See page 6 for suggested PCB holes sizes of press-fit terminations.)		
D	Ø2.54 [0.100]	Mounting connector with screws
E	Ø3.12±0.08 [0.123±0.003]	Mounting connector with push-on fasteners
Hole pattern shown is for male connector. Use mirror image for female connector.		

#### Jackscrew System

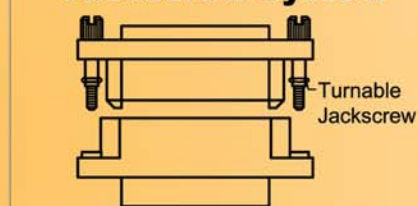

Consult factory for availability



### Goldfish 01 and 02 Right Angle (90°) Mount

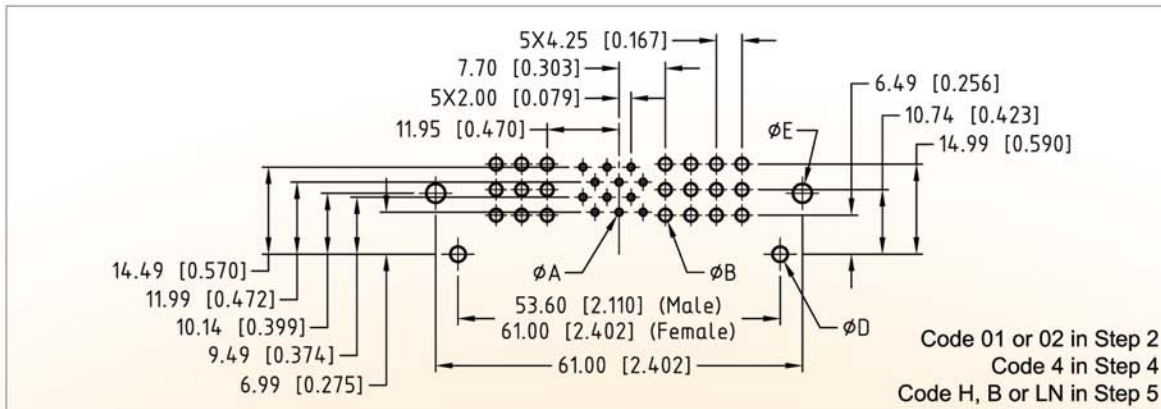

### Goldfish 435 Right Angle (90°) Mount

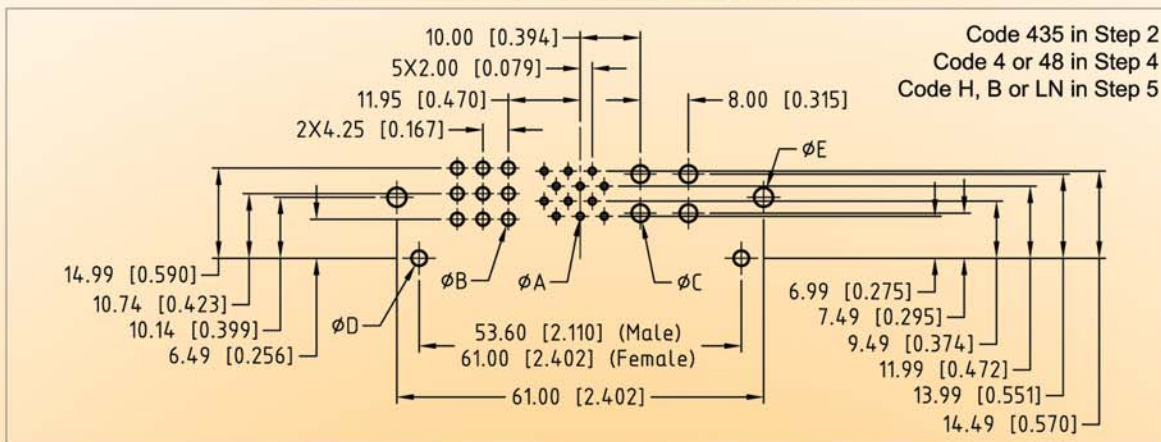

### Goldfish 928 Right Angle (90°) Mount

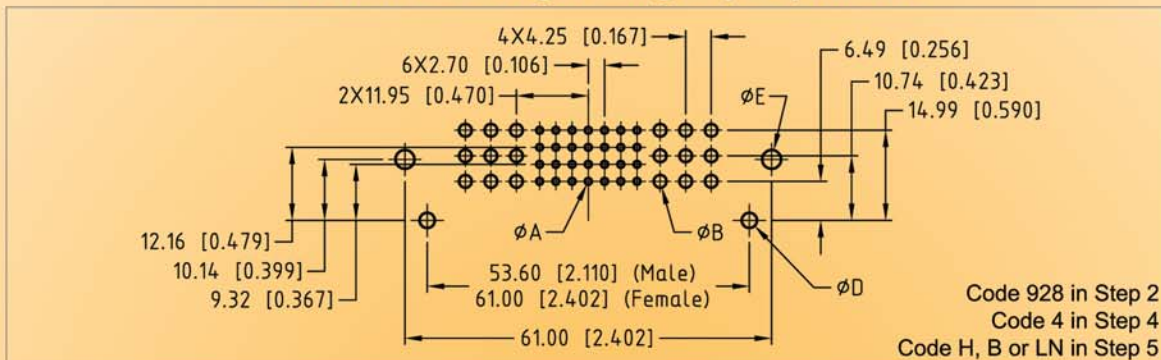

DIM	Suggested size	For use
A	Ø1.14 [0.045]	Size 20 & 22 contact terminals
B	Ø2.11 [0.083]	Size 16 contact terminals
C	Ø2.90 [0.114]	Size 12 contact terminals
D	Ø2.54 [0.100]	Mounting connector with screws
E	Ø3.12 [0.123]	Mounting connector using angle brackets

Hole pattern shown is for male connector. Use mirror image for female connector.

## Contact Hole Patterns for PCB Mount



### Baby Goldfish 109 Straight PCB Mount

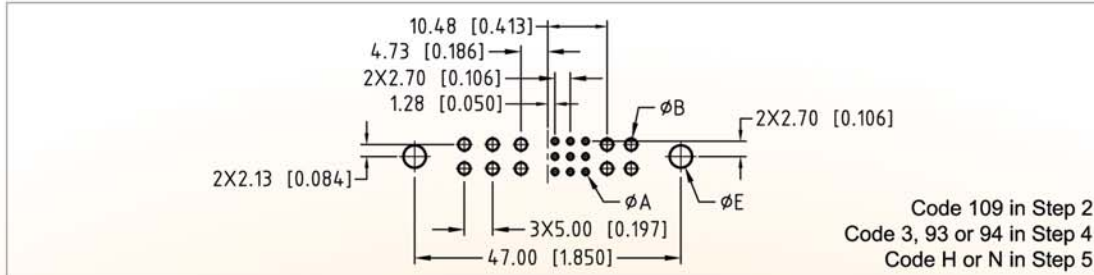

### Baby Goldfish 109 Right Angle (90°) Mount

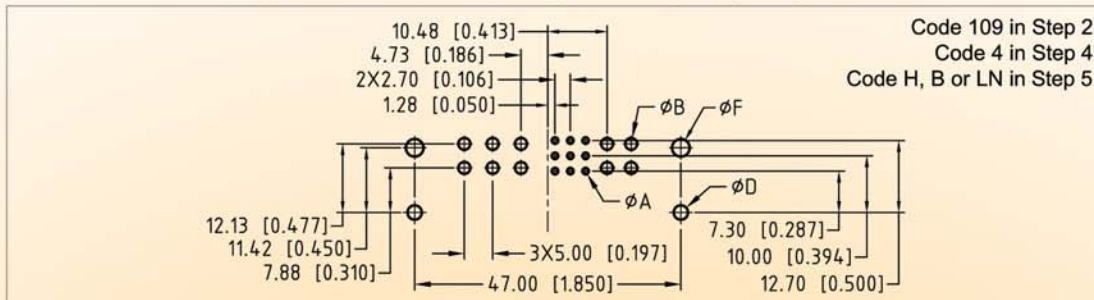

### Baby Goldfish 624 Straight PCB Mount

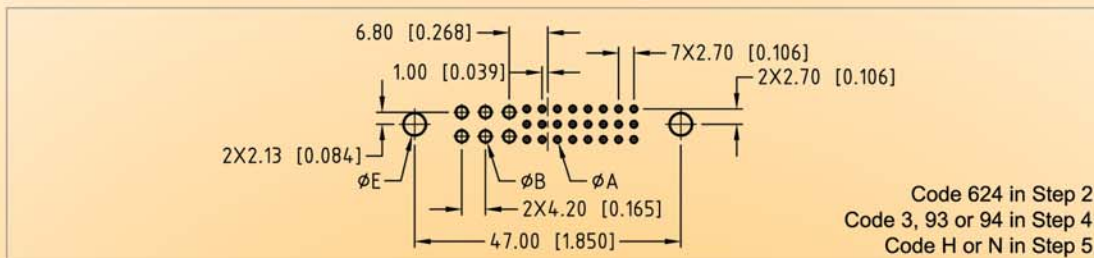

### Baby Goldfish 624 Right Angle (90°) Mount

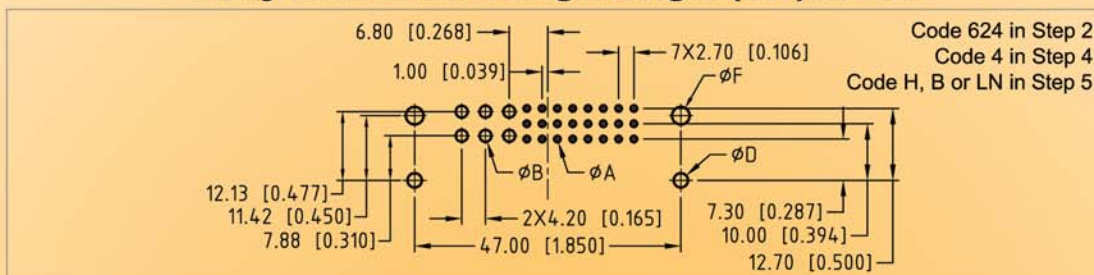

DIM	Suggested size	For use
A	$\varnothing 1.14$ [0.045]	Size 20 & 22 contact terminals
B	$\varnothing 2.11$ [0.083]	Size 16 contact terminals
C	$\varnothing 2.90$ [0.114]	Size 12 contact terminals
(See page 6 for suggested PCB holes sizes of press-fit terminations.)		
D	$\varnothing 2.54$ [0.100]	Mounting connector with screws
E	$\varnothing 3.96 \pm 0.08$ [0.156 $\pm$ 0.003]	Mounting connector with push-on fasteners/ screws
F	$\varnothing 3.12$ [0.123]	Mounting connector using angle brackets

Hole pattern shown is for male connector. Use mirror image for female connector.

## Removable Crimp Contact

Consult factory for sequential mating and super conductive material options.



### Size 12

Female

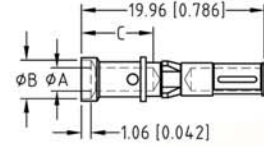

Male

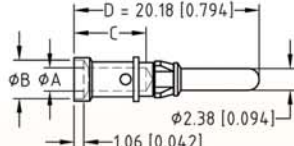

\* First mate contact, D = 23.18 [0.913]

Female Contact	Male Contact	** Wire Size AWG [mm <sup>2</sup> ]	ØA	ØB	C
FC610N2	MC610N	10 [6.0]	3.73 [0.147]	N/A	6.45 [0.254]
	MC610N-228.1*				
*** FC610N2S	MC610NS				
FC612N2	MC612N	12 [4.0]	2.54 [0.100]	4.19 [0.165]	7.90 [0.311]
	MC612N-228.1*				
*** FC612N2S	MC612NS				

\*\*\* Super conductive material: High conductive copper alloy.

### Size 16

Female

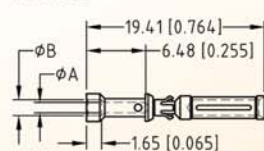

Male

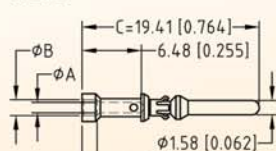

\* First mate contact, C = 21.74 [0.856]

Female Contact	Male Contact	** Wire Size AWG [mm <sup>2</sup> ]	ØA	ØB
FC112N2	MC112N	12 [4.0]	2.49 [0.098]	N/A
	MC112N-133.5*			
*** FC112N2S	MC112NS			
FC114N2	MC114N	14-16 [2.5-1.5]	2.06 [0.081]	2.64 [0.104]
	MC114N-133.5*			
FC116N2	MC116N	16-18 [1.5-1.0]	1.70 [0.067]	2.36 [0.093]
	MC116N-133.5*			
FC120N2	MC120N	20-22-24 [0.5-0.3-0.25]	1.14 [0.045]	1.73 [0.068]
	MC120N-133.5*			

\*\*\* Super conductive material: High conductive copper alloy.

### Size 20

Female

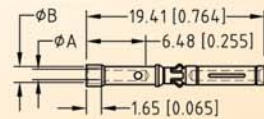

Male

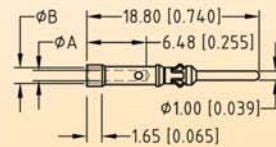

Female Contact	Male Contact	** Wire Size AWG [mm <sup>2</sup> ]	ØA	ØB
FC720N2	MC720N	20-22-24 [0.5-0.3-0.25]	1.14 [0.045]	1.73 [0.068]

### Size 22

Female

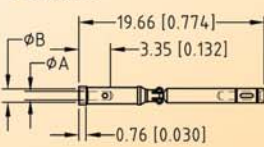

Male

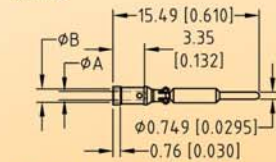

\*\* Note: Please use correct wire size and it should be smaller than ØA of the contact.

Female Contact	Male Contact	** Wire Size AWG [mm <sup>2</sup> ]	ØA	ØB
FC420N6	MC420N	20 [0.5]	1.14 [0.045]	N/A
FC422N6	MC422N	22 [0.3]	0.89 [0.035]	1.42 [0.056]

## Removable, Solder, Straight PCB Mount, Contacts

### Size 16

FDS16G3N2

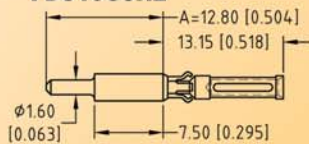

FDS16G3N3, A = 12.00 [0.472]

MDS16G3N

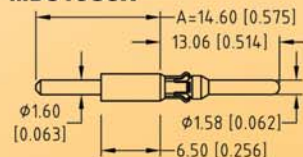

MDS16G3N4, A = 13.31 [0.516]

Now you can easily mix crimp terminations and PCB mount solder terminations within one connector!

For use in crimp version connectors.

### Size 20

FDS20G3N2

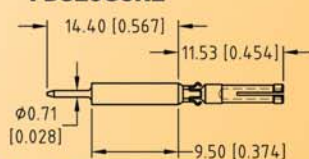

MDS20G3N

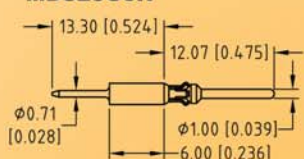

### Size 22

FDS22G3N2

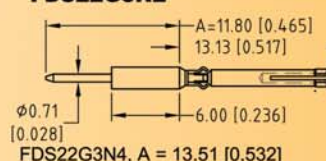

FDS22G3N4, A = 13.51 [0.532]

MDS22G3N

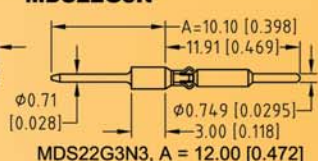

MDS22G3N3, A = 12.00 [0.472]

### Contacts Ordering Information

Connector Variant	Power Contact	Signal Contact
GFSH01/02F1H	FDS16G3N2	FDS20G3N2
GFSH01/02M1H	MDS16G3N	MDS20G3N
GFSH109/624F1H	FDS16G3N3	FDS22G3N2
GFSH109/624M1H	MDS16G3N4	MDS22G3N
GFSH928F1H	FDS16G3N2	FDS22G3N4
GFSH928M1H	MDS16G3N	MDS22G3N3

Reference contact tail length is 4.50 [1.77].

Consult factory for other contact sizes.

# GOLDFISH

## Connector Ordering Information

Specify complete connector by following step 1 through step 5  
Include step 6 for customized connectors.



GFSH					02	F	4	LN	-	XXXXX
<b>STEP 1: Basic Series</b> GFSH : Goldfish Series					<b>STEP 6: Special Options</b> Consult factory for customization of Goldfish Power Connectors. E.g. selective loading, sequential mating, etc.					
<b>STEP 2: Connector Versions</b> 01 : Partially populated connector with 16 size 16 power contacts and 10 size 20 signal contacts. 02 : Fully populated connector with 21 size 16 power contacts and 12 size 20 signal contacts. 109 : Fully populated connector with 10 size 16 power contacts and 9 size 22 signal contacts. 435 : Fully populated connector with 9 size 16 power contacts, 4 size 12 power contacts and 12 size 20 signal contacts. 624 : Fully populated connector with 6 size 16 power contacts and 24 size 22 signal contacts. 928 : Fully populated connector with 18 size 16 power contacts and 28 size 22 signal contacts.					<b>STEP 5: Mounting Style</b> H : No hardware. For mounting connector with self-tapping screws. (Order screws separately.) 82 : Panel/ float mount for 1.5 mm thick panel. 83 : Panel/ float mount for 2.3 mm thick panel. B : Right angle (90°) PCB mount through hole angle brackets. LN : Right angle (90°) PCB mount board lock angle brackets. N : Straight PCB mount push-on fasteners.					
<b>STEP 3: Connector Gender</b> F : Female M : Male					<b>STEP 4: Type of Contact</b> 1 : Removable contact, panel/ float mount. (contacts ordered separately). 3 : Solder, straight PCB mount. 4 : Solder, right angle (90°) PCB mount. 38 : Solder, straight PCB mount, GFSH435 only, (super conductive size 12 power contacts). 48 : Solder, right angle (90°) PCB mount, GFSH435 only, (super conductive size 12 power contacts). * 93 : Press-fit compliant terminations. * 94 : Press-fit compliant terminations. *Consult factory for GFSH435.					

Good luck ... turns into a great power connector!!!



For the best in Interconnection Power Density

- . Blind Mating - Float Mounting
- . Hot Plug Capability
- . AC, DC and Signal in one connector
- . 2 sizes, 5 versions
- . Uh, CSA Recog.
- . 20, 35 and 50 amp contacts

## Recommended Tools for Crimp Contacts



### CONTACT EXTRACTION TOOLS

Shown for reference only.



### CONTACT INSERTION TOOLS

Shown for reference only.



### CYCLE-CONTROLLED STEP ADJUSTABLE HAND CRIMP TOOLS

Shown for reference only.



Contact size	Contact extraction tool	Contact insertion tool	Hand crimp tool	Semi-Automatic Crimp Machine
Size 12	2711-0	9099-3	9509-6 (MC/FC610) 9501-0 with 9502-19 positioner (MC/FC612)	-
Size 16	9081-0	9099-0	9501-0 with 9502-1 positioner 9501-0 with 9502-17 positioner (male first mate contacts)	9550-0
Size 20	9081-2	9099-4	9507-0 with 9502-21 positioner (male contacts) 9507-0 with 9502-22 positioner (female contacts)	9550-1
Size 22	9081-3	9099-1	9507-0 with 9502-12 positioner (male contacts) 9507-0 with 9502-20 positioner (female contacts)	

## Semi-Automatic Crimp Machine

### Part No. 9550-0

This fast cycling and reliable automatic crimp machine produces a four double-indent crimp, meeting Military Standard and proprietary specifications on wire sizes 12 AWG (4.0mm<sup>2</sup>) through 30 AWG (0.05mm<sup>2</sup>).

The tool is a bench mount pneumatic unit of compact size and weight. Contacts must be ordered separately and are supplied on a reel in quantities of 2000.

To order, specify part number 9550-0. Foot pedal control valve is supplied as a standard accessory.

### CONTACT CARRIERS

Molded thermoplastic carriers in a continuous belt feed contacts to the crimp station of the automatic feed tool. They also locate the contacts in respect to the tool's indenters. The carriers are color coded white and natural for contact identification for both MS and proprietary applications. Part number for contacts supplied in reels ends with a 'R', example, FC114N2R.

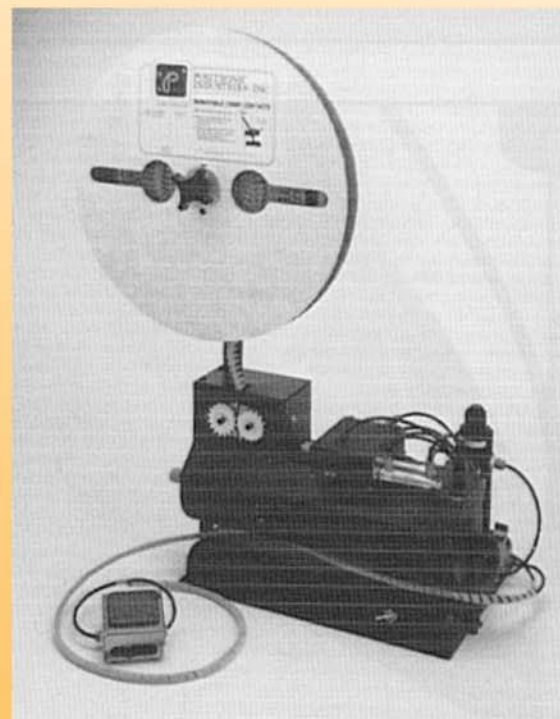
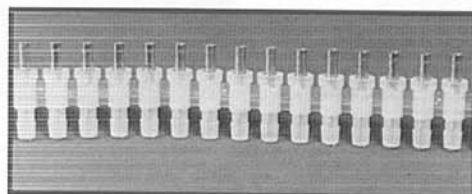

Machine not sold; on rent only.

## ASIA / PACIFIC SALES OFFICES

Singapore Factory, Sales and Engineering Office	+65 6842 1419	
Japan	+813 5661 3047	japan@connectpositronic.com
South Korea	+82 31 909 8047	korea@connectpositronic.com
India	+91 20 5623 5258	india@connectpositronic.com
Taiwan	+886 2 2937 8775	taiwan@connectpositronic.com
China	+86 13 6 0262 7840	shenzhen@connectpositronic.com
Beijing	+86 10 6296 9275	
Chengdu	+86 28 8669 8195	
Shanghai	+86 21 6487 3477	
ShenZhen	+86 755 8294 7272	
Malaysia	+60 4 644 9688	
New Zealand	+64 3 358 5154	
Australia (Military)	+61 2 8966 3600	
Australia ( Commercial)	+61 2 4328 5783	

## NORTH AMERICAN SALES OFFICES

United States, Springfield, Missouri	
Factory and Sales Office	800 641 4054
Puerto Rico Sales Office	787 841 0920
Mexico Sales Office	800 872 7674
Canada Sales Office	800 327 8272

## EUROPEAN SALES OFFICES

France, Auch Factory and Sales	33 (0)5 6263 4491
Northern France Sales Office	33 (0)1 4588 1388
Southern France Sales Office	33 (0)4 6772 8028
Italy Sales Office	39 (0)2 5411 6106
Germany Sales Office	49 (0)23 5163 4739

Europe & Middle East Technical Agents:

Austria, Benelux, Denmark, Finland, Greece, United Kingdom  
Ireland, Scotland, Slovenia, Spain, Sweden, Switzerland, Israel and Turkey

## POSITRONIC INDUSTRIES, INC

423 N Campbell Avenue, P O Box 8247, Springfield, MO 65801, USA  
Telephone: 1 417 866 2322 Fax: 1 417 866 4115  
Email: info@connectpositronic.com

## POSITRONIC INDUSTRIES, SA

Zone Industrielle Est, 46 Route d'Engachies, F32020, Auch Cedex 9, France  
Telephone: 33 05 62 63 44 91 Telecopieur: 33 (0)5 62 63 51 17  
Email: contact@connectpositronic.com

## POSITRONIC ASIA PTE LTD

3014A Ubi Road 1 # 07-01 Singapore 408703  
Telephone: 65 6842 1419 Fax: 65 6842 1421  
Email: singapore@connectpositronic.com

[www.connectpositronic.com](http://www.connectpositronic.com)



# Baby Baby Goldfish

## Miniature High Density Power Connectors For Drawer Applications

Excellent Power Density • Blind Mating • 20 and 30 Amperes Power Contacts  
Power and Signal Contacts in One Connector • Tested to 10,000 Mating Cycles

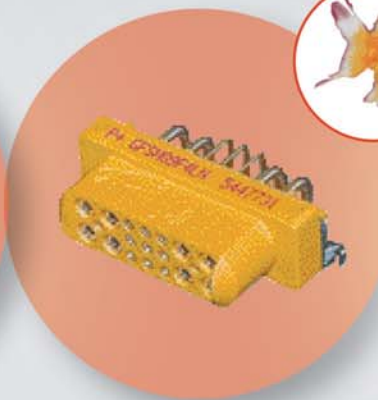

**GFSH89**

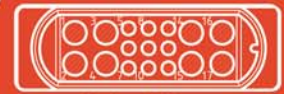

Actual Size

GFSH89: Fully populated connector  
Number of size 16 power contacts: 8  
Number of size 22 signal contacts: 9

The Original Baby Goldfish Connector



GFSH109

Shown for reference only.  
For other version and sizes, please see standard Goldfish Connector Catalog.

**GOLDFISH**  
Interconnection Systems

### Technical Characteristics

#### Materials and Finishes

Insulator: Glass-filled nylon, UL 94V-0.  
Contacts: Precision machined copper alloy with gold over nickel plate.

#### Electrical Characteristics

Contact Current Ratings  
Size 16 Contacts: 20 amperes, continuous.  
30 amperes, continuous (super conductive material).  
Size 22 Contacts: 3 amperes, nominal.  
Initial Contact Resistance (max.) per IEC 512-2, Test 2b.  
Size 16 Contacts: 0.003 ohms  
0.001 ohms (super conductive material)  
Size 22 Contacts: 0.005 ohms  
Insulator Resistance: 5 G ohms min. per IEC 512-2, Test 3a.

Proof Voltage  
Power Contacts: 1300 V r.m.s.  
Signal Contacts: 1000 V r.m.s.

Working Voltage  
Power Contacts: 150 V r.m.s.  
Signal Contacts: 333 V r.m.s.

(For higher voltage capability, please contact factory.)

#### Mechanical Characteristics

Blind Mating System: Molded in guides allow for misalignment up to 2.00 mm [0.079 inch].  
Polarization: Provided by insulator.  
Removable Contacts: Install contact from rear of insulator; release with extraction tool from front of insulator. Female contacts feature "closed entry" 1,000 cycles design. (Contact factory for 10,000 cycles capability.)  
Fixed Contacts: Size 16 female contacts feature "closed entry" 1,000 cycles design (for both straight & right angle (90°) PCB mount).  
Contact Retention in insulator (removable and fixed)  
Power Contacts: 45 N [10 lbs.] min.  
Signal Contacts: 27 N [6 lbs.] min.  
Sequential Mating: Two level systems available.

#### Climatic Characteristics

Working temperature: -55° to +125°C.

#### Recognized

UL : Baby Baby Goldfish Certification in Process

Standard and Baby Goldfish UL File E49351

Catalog A - 003 Rev. NC



**Positronic Industries**  
www.connectpositronic.com





### Temperature Rise & Contact Performance

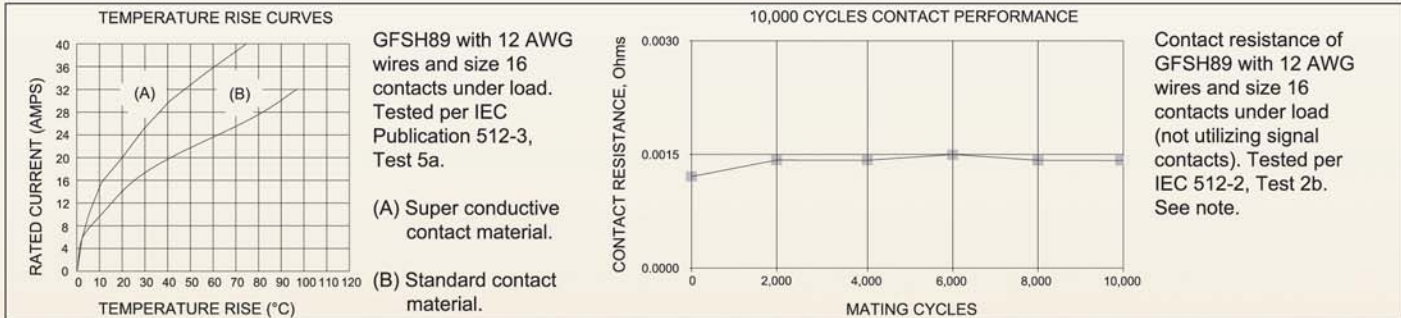

Note: This information is supplied for reference. Contact wear and change in contact resistance may vary from one application to another. Contact technical sales to discuss details.

### Straight and Right Angle (90°) PCB Mount Connector Outline Dimensions

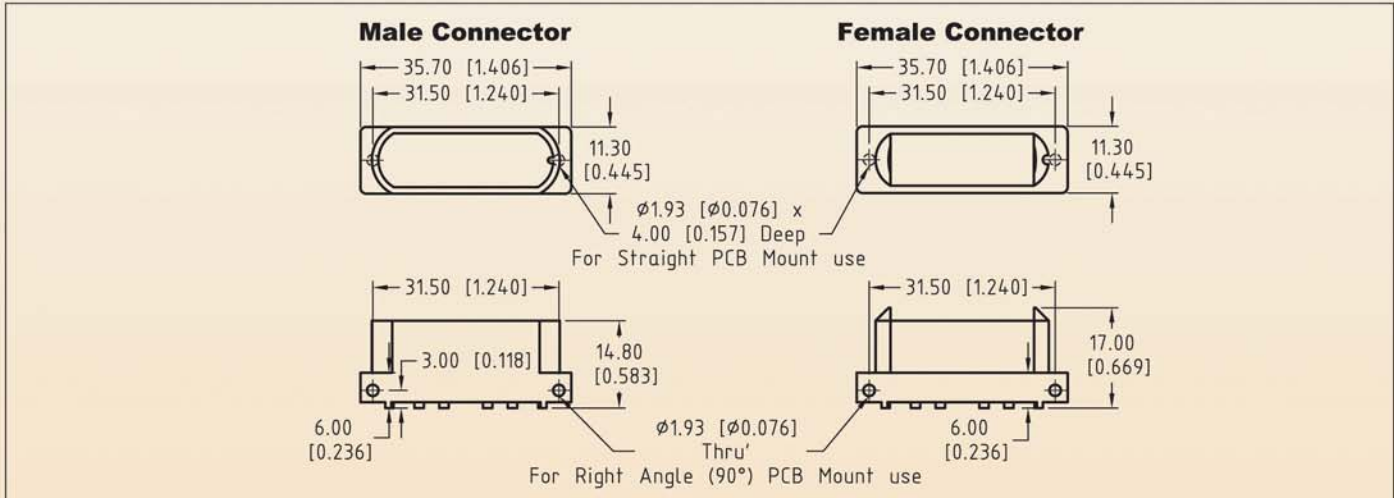

### Straight and Right Angle (90°) PCB Mount Connector Contact Termination Dimensions See Step 4 of Ordering Information

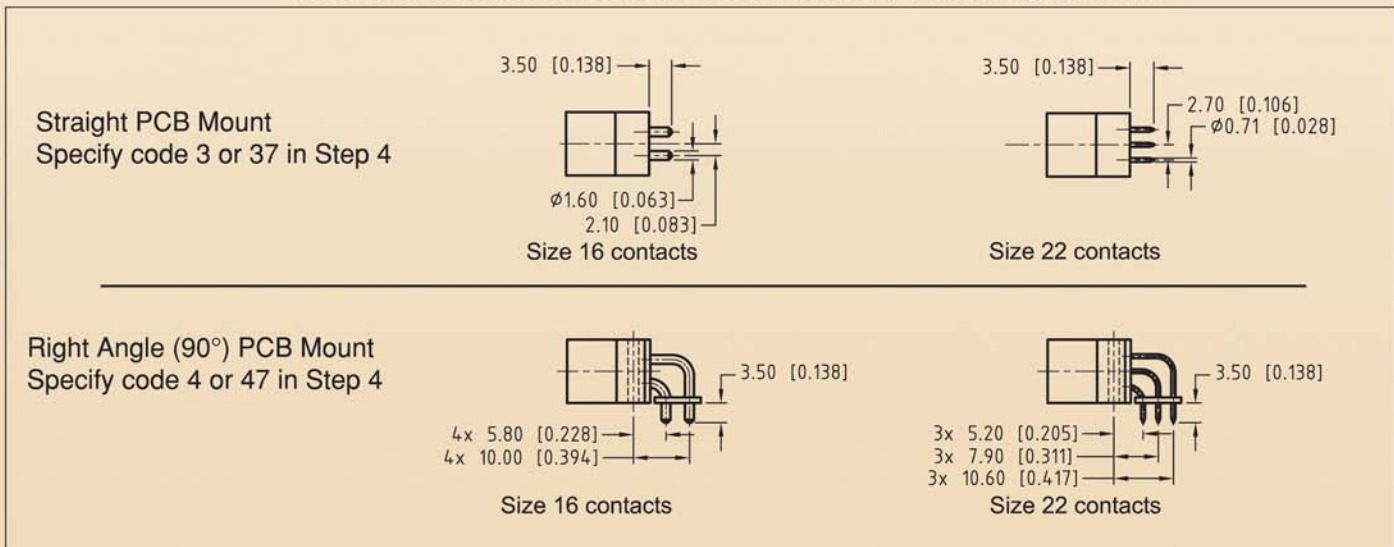

Connector shown is male. Unless otherwise specified, above dimensions are identical to female connector.



### Panel Mount Connector

Specify code 1 in Step 4 of Ordering Information

#### Outline Dimensions

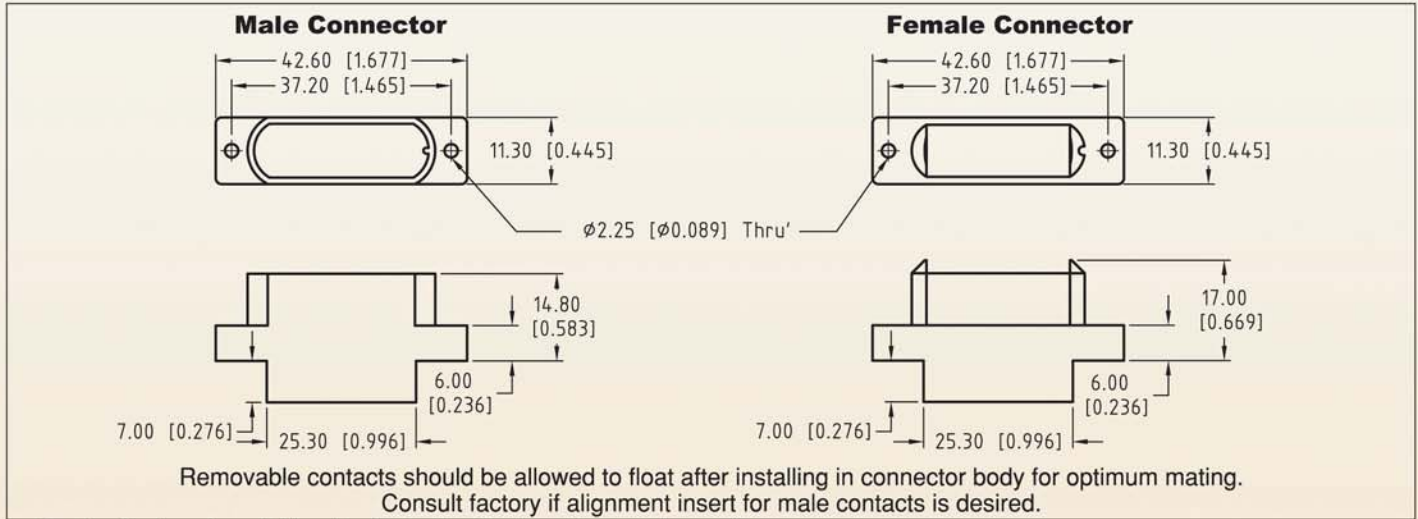

Contact factory for additional polarization features for panel mounting.

#### Mounting Styles

<b>Right Angle (90°) Mounting Brackets</b> 	Specify code B or LN. Material: Brass with Tin plating.	<b>Push-on Fastener</b> 	<b>Goldfish</b> 89	<b>"A"</b> 3.34 [0.131]
			Specify code N. Material: Copper Alloy with Tin plating	
Through Hole (B)    With Board Lock (LN)	7.65 [0.301]			

#### Contact Hole Patterns

<b>Straight PCB Mount</b>		Code 89 in Step 2 Code 3, 37, *93 or *94 in Step 4 Code H or N in Step 5
		* See standard Goldfish Connector Catalog for Contact Hole Dimensions
<b>Right Angle (90°) Mount</b>		Code 89 in Step 2 Code 4 or 47 in Step 4 Code H, B or LN in Step 5

<b>DIM</b>	<b>Suggested size</b>	<b>For use</b>	<b>DIM</b>	<b>Suggested size</b>	<b>For use</b>
A	Ø1.14 [0.045]	Size 22 contact terminals	D	Ø3.12±0.08 [0.123±0.003]	Mounting connector with push-on fasteners
B	Ø2.11 [0.083]	Size 16 contact terminals	E	Ø3.12 [0.123]	Mounting connector using angle brackets (not required with screws mounting)
C	Ø2.54 [0.100]	Mounting connector with screws (not required with angle brackets mounting)			

## Removable Crimp Contacts

Consult factory for other contact types, sequential mating and super conductive material options.  
For crimping and contact extraction tools, please contact factory or see standard Goldfish Connector Catalog.

### Size 16

#### Female

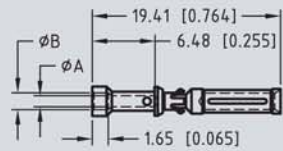

#### Male

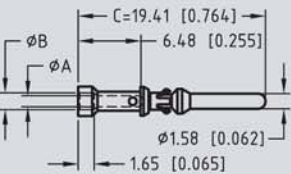

\* First mate contact,  
C = 21.74 [0.856]

Female Contact	Male Contact	** Wire Size AWG [mm <sup>2</sup> ]	ØA	ØB
FC112N2	MC112N	12 [4.0]	2.49 [0.098]	N/A
	MC112N-133.5*			
FC112N2S	MC112NS			
FC114N2	MC114N	14-16 [2.5-1.5]	2.06 [0.081]	2.64 [0.104]
	MC114N-133.5*			
FC116N2	MC116N	16-18 [1.5-1.0]	1.70 [0.067]	2.36 [0.093]
	MC116N-133.5*			
FC120N2	MC120N	20-22-24 [0.5-0.3-0.25]	1.14 [0.045]	1.73 [0.068]
	MC120N-133.5*			

\*\*\* Super conductive material: High conductive copper alloy.

### Size 22

#### Female

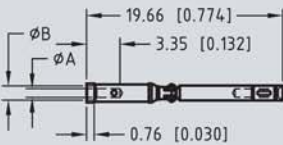

#### Male

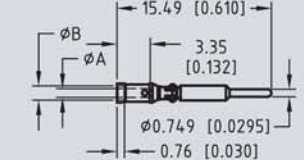

Female Contact	Male Contact	** Wire Size AWG [mm <sup>2</sup> ]	ØA	ØB
FC420N6	MC420N	20 [0.5]	1.14 [0.045]	N/A
FC422N6	MC422N	22 [0.3]	0.89 [0.035]	1.42 [0.056]

\*\* Note: Please use correct wire size and it should be smaller than ØA of the contact.

## Connector Ordering Information

Specify complete connector by following step 1 through step 5. Include step 6 for customized connectors.

**GFSH 89 F 4 LN - XXXXX**

**STEP 1: Basic Series**  
GFSH : Goldfish Series

**STEP 2: Connector Version**  
89 : Fully populated connector with 8 size 16 power contacts and 9 size 22 signal contacts.

**STEP 3: Connector Gender**  
F : Female  
M : Male

**STEP 4: Type of Contact**

- 1 : Removable contact, panel mount. (contacts ordered separately).
- 3 : Solder, straight PCB mount.
- 37 : Solder, straight PCB mount (super conductive size 16 power contacts).
- 4 : Solder, right angle (90°) PCB mount
- 47 : Solder, right angle (90°) PCB mount (super conductive size 16 power contacts).
- 93 : Press-fit compliant terminations. PCB Thickness: 2.29 to 4.45 [0.090 to 0.175]
- 94 : Press-fit compliant terminations. PCB Thickness: 4.45 [0.175] min.

**STEP 6: Special Options**  
Consult factory for customization of Baby Baby Goldfish E.g. selective loading, sequential mating, etc.

**STEP 5: Mounting Style**

- H : No hardware. For mounting connector with self-tapping screws. (Order screws separately.)
- B : Right angle (90°) PCB mount through hole angle brackets.
- LN : Right angle (90°) PCB mount board lock angle brackets.
- N : Straight PCB mount push-on fasteners.

**Unless otherwise specified, dimensional tolerances for Baby Baby Goldfish products are:**

1. Male contact mating diameters : ±0.03 [0.001]
2. Contact termination diameters : ±0.08 [0.003]
3. All diameters : ±0.13 [0.005]
4. All other dimensions : ±0.38 [0.015]

All dimensions are in millimeters [ inches]

## Contact us about RoHS Compliance

Positronic Industries believes the data contained herein to be reliable. Since the technical information is given free of charge, the user employs such information at his own discretion and risk. Positronic Industries assumes no responsibility for results obtained or damages incurred from use of such information in whole or in part.

**POSITRONIC INDUSTRIES, INC.**  
423 N Campbell Ave  
PO Box 8247 • Springfield, MO 65801  
Telephone (417) 866-2322  
Fax (417) 866-4115  
Toll Free (800) 641-4054  
[info@connectpositronic.com](mailto:info@connectpositronic.com)

**POSITRONIC INDUSTRIES, S.A.S.**  
Zone Industrielle d'Engachies  
46 Route d'Engachies  
France 32020 Auch Cedex 9  
Telephone 33 (0) 5 6263 4491  
Fax 33 (0) 5 6263 5117  
[contact@connectpositronic.com](mailto:contact@connectpositronic.com)

**POSITRONIC ASIA PTE LTD.**  
Blk 3014A  
Ubi Road 1 #07-01  
Singapore 408703  
Telephone 65 6842 1419  
Fax 65 6842 1421  
[singapore@connectpositronic.com](mailto:singapore@connectpositronic.com)

# GOLDFISH

