



SONY®

At Sony we are constantly rethinking and redesigning in order to create innovative digital entertainment products. And we are also constantly rethinking and re-evaluating our products, processes and our potential impact on the planet.
 Thanks to our results in that direction, this product achieved the European Eco label award issued by the European Commission. You can get more information in following link:
<http://europa.eu.int/comm/environment/ecolabel>

Sony gives a minimum of 2 years guarantee for this LCD TV and 7 years availability for replacement of electronic parts.

LCD Digital Colour TV

Operating Instructions

- KDL-40E55xx KDL-46W55/57xx
- KDL-32E55xx KDL-40W55/57xx
- KDL-52V55/56xx KDL-37W55/57xx
- KDL-46V55/56xx KDL-32W55/57xx
- KDL-40V55/56xx KDL-46WE5xx
- KDL-37V55/56xx KDL-40WE5xx
- KDL-32V55/56xx

Instructions about "Installing Wall Mount Bracket" are included within this TV's instructions manual

For useful information about Sony products
<http://www.sony-europe.com/myproduct/>



4-136-111-11(1)

U

BRAVIA

<http://www.sony.net/>

Printed in Spain

© 2009 Sony Corporation

U

4-136-111-11(1)

NOTICE FOR CUSTOMERS IN THE UNITED KINGDOM

A moulded plug complying with BS1363 is fitted to this equipment for your safety and convenience.

Should the fuse in the plug supplied need to be replaced, a 10 AMP fuse approved by ASTA or BSI to BS 1362 (i.e., marked with ⚡ or ⚡) must be used.

When an alternative type of plug is used it should be fitted with a 10 AMP FUSE otherwise the circuit should be protected by a 10 AMP FUSE at the distribution board.

If the plug supplied with this equipment has a detachable fuse cover, be sure to attach the fuse cover after you change the fuse. Never use the plug without the fuse cover. If you should lose the fuse cover, please contact your nearest Sony service station.

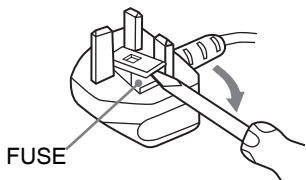
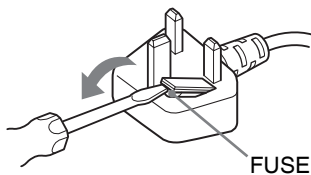

How to replace the fuse

Open the fuse compartment with a blade screwdriver, and replace the fuse. Please refer to the illustration that actually equipped with the product.

Introduction

Thank you for choosing this Sony product. Before operating the TV, please read this manual thoroughly and retain it for future reference.

The manufacturer of this product is Sony Corporation, 1-7-1 Konan Minato-ku Tokyo, 108-0075 Japan. The Authorized Representative for EMC and product safety is Sony Deutschland GmbH, Hedelfinger Strasse 61, 70327 Stuttgart, Germany. For any service or guarantee matters please refer to the addresses given in separate service or guarantee documents.

Notes on Digital TV function

- Any functions related to Digital TV (DVB) will only work in countries or areas where DVB-T (MPEG-2 and H.264/MPEG-4 AVC) digital terrestrial signals are broadcast or where you have access to a compatible DVB-C (MPEG-2 and H.264/MPEG-4 AVC) cable service. Please confirm with your local dealer if you can receive a DVB-T signal where you live or ask your cable provider if their DVB-C cable service is suitable for integrated operation with this TV.
- Your cable provider may charge a fee for their services, or require you to agree to its terms and conditions of business.
- This TV set complies with DVB-T and DVB-C specifications, but compatibility with future DVB-T digital terrestrial and DVB-C digital cable broadcasts are not guaranteed.
- Some Digital TV functions may not be available in some countries/areas and DVB-C cable may not operate correctly with some providers.

For a list of compatible cable providers, refer to the support web site:

<http://support.sony-europe.com/TV/DVBC/>



- The illustrations used in this manual are of the KDL-40V55xx unless otherwise state.
- The "x" that appear on the model name, correspond to numeric digits related to colour variation.

Trademark information

DVB is a registered trademark of the DVB Project.

HDMI, the HDMI logo and High-Definition Multimedia Interface are trademarks or registered trademarks of HDMI Licensing LLC.

DLNA and DLNA CERTIFIED are trademarks and/or service marks of Digital Living Network Alliance.

GUIDE Plus+™ is (1) a registered trademark or trademark of, (2) manufactured under license from and (3) subject of various international patents and patent applications owned by, or licensed to, Gemstar-TV Guide International, Inc. and/or its related affiliates.

GEMSTAR-TV GUIDE INTERNATIONAL, INC. AND/OR ITS RELATED AFFILIATES ARE NOT IN ANY WAY LIABLE FOR THE ACCURACY OF THE PROGRAM SCHEDULE INFORMATION PROVIDED BY THE GUIDE PLUS+ SYSTEM. IN NO EVENT SHALL GEMSTAR-TV GUIDE INTERNATIONAL, INC. AND/OR ITS RELATED AFFILIATES BE LIABLE FOR ANY AMOUNTS REPRESENTING LOSS OF PROFITS, LOSS OF BUSINESS, OR INDIRECT, SPECIAL, OR CONSEQUENTIAL DAMAGES IN CONNECTION WITH THE PROVISION OR USE OF ANY INFORMATION, EQUIPMENT, OR SERVICES RELATING TO THE GUIDE Plus+™ SYSTEM.

Manufactured under license from Dolby Laboratories. Dolby and the double-D symbol are trademarks of Dolby Laboratories.

"BRAVIA" and BRAVIA are trademarks of Sony Corporation.

"XMB™" and "XrossMediaBar" are trademarks of Sony Corporation and Sony Computer Entertainment Inc.

HDMI
HIGH-DEFINITION MULTIMEDIA INTERFACE

DOLBY
DIGITAL PLUS

DLNA
CERTIFIED

GUIDE plus+
GEMSTAR

Table of Contents

| | |
|---|----------|
| <i>Start-up Guide</i> | 4 |
| Safety Information | 8 |
| Precautions | 9 |
| Remote and TV Controls/Indicators | 10 |
| <i>Watching TV</i> | |
| Watching TV | 15 |
| Using GUIDE Plus+™ System* and the Digital Electronic Programme Guide (EPG)** | 17 |
| Using the Favourite List | 21 |
| <i>Using Optional Equipment</i> | |
| Connecting Optional Equipment | 22 |
| Viewing Pictures from Connected Equipment..... | 24 |
| Playing back Photo/Music/Video via USB..... | 25 |
| Using BRAVIA Sync with Control for HDMI | 27 |
| <i>Using Home Network Features</i> | |
| Connecting to the Network..... | 28 |
| Enjoying AppliCast..... | 29 |
| Enjoying Photo/Music/Video Files via the Network | 30 |
| Checking the Network Connection | 31 |
| Adjusting the Server Display Settings | 31 |
| <i>Using Menu Functions</i> | |
| Navigating through TV Home Menu on XMB™..... | 32 |
| TV Settings Menu | 33 |
| <i>Additional Information</i> | |
| Installing the Accessories (Wall-Mount Bracket) | 45 |
| Specifications | 48 |
| Troubleshooting | 51 |
| Index | 57 |

Before operating the TV, please read “Safety Information” (page 8). Retain this manual for future reference.

Start-up Guide

Before Use

To check the accessories

Mains lead (Type C-6)* (1) (Except for 37/32 inches)

Stand (1) and screws (4) (Except for 52 inches)

RM-ED016 Remote (1)

RM-ED012 Remote (1) (KDL-46/40/37/32W5720/5730/5740 only)

Size AA batteries (R6 type) (2)

* Do not remove the ferrite cores.

To insert batteries into the remote

Push and lift the cover to open.

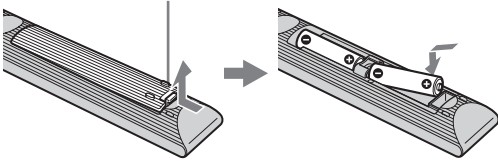

1: Attaching the stand (Except for 52 inches)

- 1 Open the carton box and take out the stand and the screws.
- 2 Place the TV set on the stand. Take care not to interfere with cables.

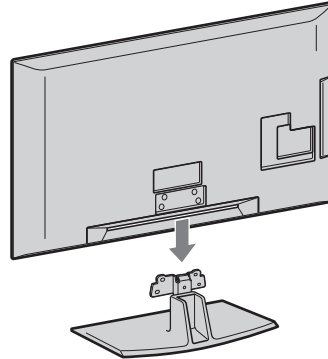

- 3 Fix the TV to the stand according to the arrow marks  that guide the screw holes using the supplied screws.

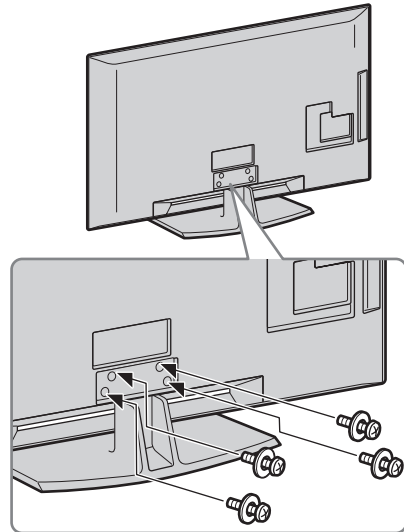

- For KDL-40E55/32E55xx you can adjust the stand to a higher position. For details refer to leaflet “How to change the height of the stand”.
- If using an electric screwdriver, set the tightening torque at approximately 1.5 N·m (15 kgf·cm).

2: Connecting an aerial/Set Top Box/recorder (e.g. DVD recorder)

Connecting a Set Top Box/recorder (e.g. DVD recorder) with SCART

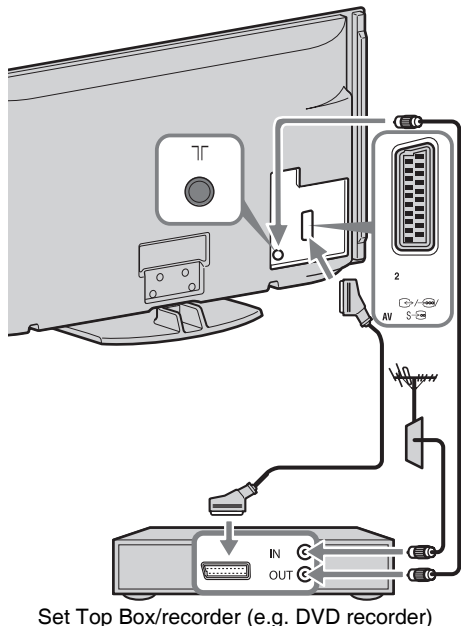

Connecting a Set Top Box/recorder (e.g. DVD recorder) with HDMI

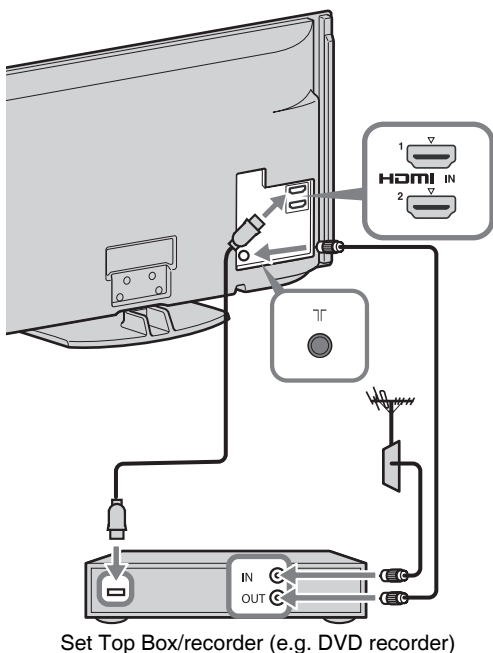

3: Preventing the TV from toppling over

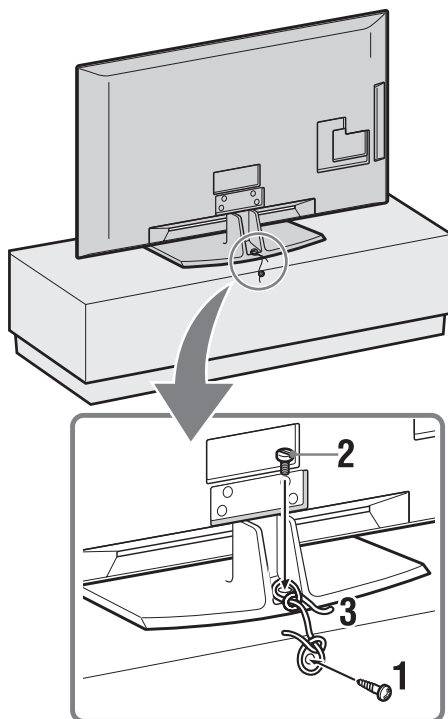

- 1 Install a wood screw (4 mm in diameter, not supplied) in the TV stand.
- 2 Install a machine screw (M5 × 20, not supplied) into the screw hole of the TV.
- 3 Tie the wood screw and the machine screw with a strong cord.

4: Bundling the cables

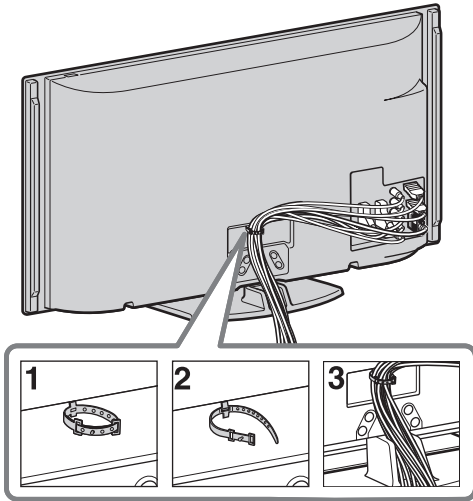

- Do not bundle the mains lead/AC power cord together with other cables.

5: Performing the initial Set-up



- 1 Connect the TV to your mains socket.
- 2 Switch **ENERGY SAVING SWITCH** on (page 10) (KDL-46WE5/40WE5xx only).
- 3 Press  on the TV.

When you switch on the TV for the first time, the Language menu appears on the screen.

4

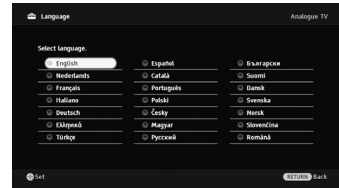

Follow the instructions on the screen.

Digital Auto Tuning: When you select “Cable”, we recommend that you select “Quick Scan” for quick tuning. Set “Frequency” and “Network ID” according to the information supplied from your cable provider. If no channel is found using “Quick Scan”, try “Full Scan” (though it may take some time). For a list of compatible cable providers, refer to the support web site: <http://support.sony-europe.com/TV/DVBC/>

Programme Sorting: If you want to change the order of analogue channels, follow the steps in “Programme Sorting” (page 41).

Eco Preset: When you select “Yes”, the “Eco” settings are changed into recommended values to reduce power consumption.

To Set-up GUIDE Plus+™ System (only when GUIDE Plus+™ System is available)*

* Condition you can set-up this feature:

- you can receive digital broadcasting.
- when “Antenna” is selected in “5: Performing the initial Set-up”.

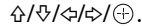
- 1 Enter postal code of region you live using .



- Enter from the left, when the postal code is fewer than seven digits.

2 Select language for GUIDE Plus+.

This step will be skipped if any one of the following languages is selected in “5: Performing the initial Set-up”: “English”, “Deutsch”, “Español”, “Italiano”, “Français” or “Nederlands”.

3 GUIDE Plus+ Data Download.

The initial download may take some time, so do not press any buttons on the TV or remote while proceeding. Once you have received the first download of TV listings data, all future downloads will be done automatically.



- You can also tune channels manually (page 41).

Adjusting the viewing angle of the TV

This TV can be adjusted within the angles shown below.

Adjust the angle left and right (swivel)

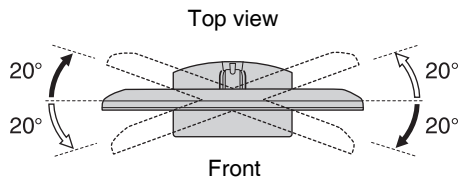

- For KDL-40E55/32E55xx swivel is locked to avoid to get your fingers caught. To unlock and move the TV set to a higher position refer to the leaflet “How to change the height of the stand”.

Detaching the Table-Top Stand from the TV



- Remove the screws guided by the arrow marks  of the TV.
- Do not remove the Table-Top Stand for any reason other than to wall-mount the TV.

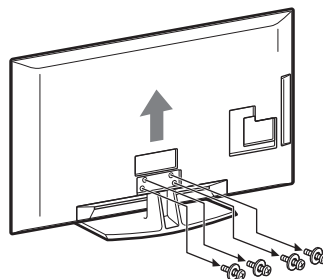

Safety Information

Installation/Set-up

Install and use the TV set in accordance with the instructions below in order to avoid any risk of fire, electrical shock or damage and/or injuries.

Installation

- The TV set should be installed near an easily accessible mains socket.
- Place the TV set on a stable, level surface.
- Only qualified service personnel should carry out wall installations.
- For safety reasons, it is strongly recommended that you use Sony accessories, including:
 - Wall-mount bracket SU-WL500
- Be sure to use the screws supplied with the Wall-mount bracket when attaching the mounting hooks to the TV set. The supplied screws are designed so that they are 8 mm to 12 mm in length when measured from the attaching surface of the mounting hook. The diameter and length of the screws differ depending on the Wall-mount bracket model. Use of screws other than those supplied may result in internal damage to the TV set or cause it to fall, etc.

8 mm - 12 mm

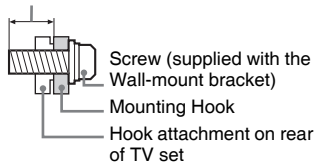

Transporting

- Before transporting the TV set, disconnect all cables.
- Two or three people are needed to transport a large TV set.
- When transporting the TV set by hand, hold it as shown on the right. Do not put stress on the LCD panel.
- When lifting or moving the TV set, hold it firmly from the bottom.
- When transporting the TV set, do not subject it to jolts or excessive vibration.
- When transporting the TV set for repairs or when moving, pack it using the original carton and packing material.

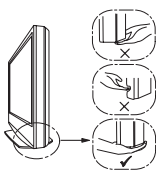
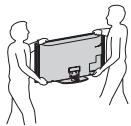

Ventilation

- Never cover the ventilation holes or insert anything in the cabinet.
- Leave space around the TV set as shown below.
- It is strongly recommended that you use a Sony wall-mount bracket in order to provide adequate air-circulation.

Installed on the wall

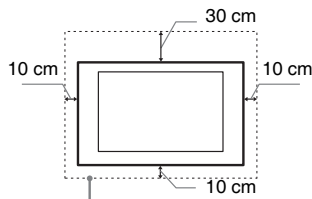

Leave at least this space around the set.

Installed with stand

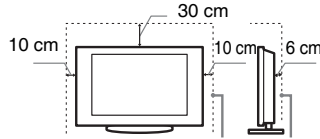

Leave at least this space around the set.

- To ensure proper ventilation and prevent the collection of dirt or dust:
 - Do not lay the TV set flat, install upside down, backwards, or sideways.
 - Do not place the TV set on a shelf, rug, bed or in a closet.
 - Do not cover the TV set with a cloth, such as curtains, or items such as newspapers, etc.
 - Do not install the TV set as shown below.

Air circulation is blocked.

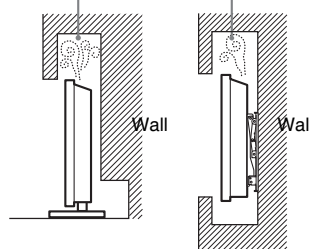

Mains lead

Handle the mains lead and socket as follows in order to avoid any risk of fire, electrical shock or damage and/or injuries:

- Use only mains leads supplied by Sony, not other suppliers.
- Insert the plug fully into the mains socket.
- Operate the TV set on a 220–240 V AC supply only.
- When wiring cables, be sure to unplug the mains lead for your safety and take care not to catch your feet on the cables.
- Disconnect the mains lead from the mains socket before working on or moving the TV set.
- Keep the mains lead away from heat sources.
- Unplug the mains plug and clean it regularly. If the plug is covered with dust and it picks up moisture, its insulation may deteriorate, which could result in a fire.

Notes

- Do not use the supplied mains lead on any other equipment.
- Do not pinch, bend, or twist the mains lead excessively. The core conductors may be exposed or broken.
- Do not modify the mains lead.
- Do not put anything heavy on the mains lead.
- Do not pull on the mains lead itself when disconnecting the mains lead.
- Do not connect too many appliances to the same mains socket.
- Do not use a poor fitting mains socket.

Prohibited Usage

Do not install/use the TV set in locations, environments or situations such as those listed below, or the TV set may malfunction and cause a fire, electrical shock, damage and/or injuries.

Location:

Outdoors (in direct sunlight), at the seashore, on a ship or other vessel, inside a vehicle, in medical institutions, unstable locations, near water, rain, moisture or smoke.

Environment:

Places that are hot, humid, or excessively dusty; where insects may enter; where it might be exposed to mechanical vibration, near flammable objects (candles, etc). The TV set shall not be exposed to dripping or splashing and no objects filled with liquids, such as vases, shall be placed on the TV.

Situation:

Do not use when your hands are wet, with the cabinet removed, or with attachments not recommended by the manufacturer. Disconnect the TV set from mains socket and aerial during lightning storms.

Broken pieces:

- Do not throw anything at the TV set. The screen glass may break by the impact and cause serious injury.
- If the surface of the TV set cracks, do not touch it until you have unplugged the mains lead. Otherwise electric shock may result.

When not in use

- If you will not be using the TV set for several days, the TV set should be disconnected from the mains for environmental and safety reasons.
- As the TV set is not disconnected from the mains when the TV set is just turned off, pull the plug from the mains to disconnect the TV set completely.
- However, some TV sets may have features that require the TV set to be left in standby to work correctly.

For children

- Do not allow children to climb on the TV set.
- Keep small accessories out of the reach of children, so that they are not mistakenly swallowed.

If the following problems occur...

Turn off the TV set and unplug the mains lead immediately if any of the following problems occur.

Ask your dealer or Sony service centre to have it checked by qualified service personnel.

When:

- Mains lead is damaged.
- Poor fitting of mains socket.
- TV set is damaged by being dropped, hit or having something thrown at it.
- Any liquid or solid object falls through openings in the cabinet.

Precautions

Viewing the TV

- View the TV in moderate light, as viewing the TV in poor light or during long period of time, strains your eyes.
- When using headphones, adjust the volume so as to avoid excessive levels, as hearing damage may result.

LCD Screen

- Although the LCD screen is made with high-precision technology and 99.99% or more of the pixels are effective, black dots may appear or bright points of light (red, blue, or green) may appear constantly on the LCD screen. This is a structural property of the LCD screen and is not a malfunction.
- Do not push or scratch the front filter, or place objects on top of this TV set. The image may be uneven or the LCD screen may be damaged.
- If this TV set is used in a cold place, a smear may occur in the picture or the picture may become dark. This does not indicate a failure. These phenomena disappear as the temperature rises.
- Ghosting may occur when still pictures are displayed continuously. It may disappear after a few moments.
- The screen and cabinet get warm when this TV set is in use. This is not a malfunction.
- The LCD screen contains a small amount of liquid crystal. Some fluorescent tubes used in this TV set also contain mercury. Follow your local ordinances and regulations for disposal.

Handling and cleaning the screen surface/cabinet of the TV set

Be sure to unplug the mains lead connected to the TV set from mains socket before cleaning.

To avoid material degradation or screen coating degradation, observe the following precautions.

- To remove dust from the screen surface/cabinet, wipe gently with a soft cloth. If dust is persistent, wipe with a soft cloth slightly moistened with a diluted mild detergent solution.
- Never use any type of abrasive pad, alkaline/acid cleaner, scouring powder, or volatile solvent, such as alcohol, benzene, thinner or insecticide. Using such materials or maintaining prolonged

contact with rubber or vinyl materials may result in damage to the screen surface and cabinet material.

- Periodic vacuuming of the ventilation openings is recommended to ensure to proper ventilation.
- When adjusting the angle of the TV set, move it slowly so as to prevent the TV set from moving or slipping off from its table stand.

Optional Equipment

Keep optional components or any equipment emitting electromagnetic radiation away from the TV set. Otherwise picture distortion and/or noisy sound may occur.

Batteries

- Observe the correct polarity when inserting batteries.
- Do not use different types of batteries together or mix old and new batteries.
- Dispose of batteries in an environmentally friendly way. Certain regions may regulate the disposal of batteries. Please consult your local authority.
- Handle the remote with care. Do not drop or step on it, or spill liquid of any kind onto it.
- Do not place the remote in a location near a heat source, a place subject to direct sunlight, or a damp room.

Disposal of the TV set



Disposal of Old Electrical & Electronic Equipment (Applicable in the European

Union and other European countries with separate collection systems)

This symbol on the product or on its packaging indicates that this product shall not be treated as household waste. Instead it shall be handed over to the applicable collection point for the recycling of electrical and electronic equipment. By ensuring this product is disposed of correctly, you will help prevent potential negative consequences for the environment and human health, which could otherwise be caused by inappropriate waste handling of this product. The recycling of materials will help to conserve natural resources. For more detailed information about recycling of this product, please contact your local Civic Office, your household waste disposal service or the shop where you purchased the product.



Disposal of waste batteries (applicable in the European Union and other European countries with separate collection systems)

This symbol on the battery or on the packaging indicates that the battery provided with this product shall not be treated as household waste. By ensuring these batteries are disposed of correctly, you will help prevent potentially negative consequences for the environment and human health which could otherwise be caused by inappropriate waste handling of the battery. The recycling of the materials will help to conserve natural resources. In case of products that for safety, performance or data integrity reasons require a permanent connection with an incorporated battery, this battery should be replaced by qualified service staff only. To ensure that the battery will be treated properly, hand over the product at end-of-life to the applicable collection point for the recycling of electrical and electronic equipment. For all other batteries, please view the section on how to remove the battery from the product safely. Hand the battery over to the applicable collection point for the recycling of waste batteries. For more detailed information about recycling of this product or battery, please contact your local Civic Office, your household waste disposal service or the shop where you purchased the product.

Remote and TV Controls/Indicators

Remote and TV controls

In case of KDL-46/40/37/32W5720/5730/5740, please refer to the separate leaflet.

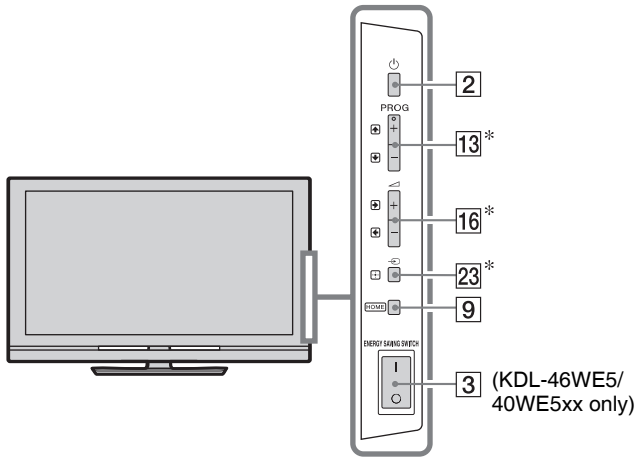



Buttons on the TV will work the same as those on the remote.

* In the TV menu, these buttons will work as $\uparrow/\downarrow/\leftarrow/\rightarrow/\oplus$.



- The number 5, \blacktriangleright , **PROG +** and **AUDIO** buttons on the remote have a tactile dot. Use the tactile dots as a reference when operating the TV.

| Button/Switch | Description |
|---|---|
| 1 I/Power (TV standby) | Press to turn the TV on and off from standby mode. |
| 2 Power (Power) | Press to turn the TV on or off.  <ul style="list-style-type: none"> • To turn the TV completely off (0 W, no power consumption), turn off the TV, then unplug the mains lead/AC power cord from the mains/AC power. • For KDL-46WE5/40WE5xx, you can also turn the TV off completely by switching ENERGY SAVING SWITCH off (page 10). |
| 3 ENERGY SAVING SWITCH (KDL-46WE5/40WE5xx only) | Turns the TV completely off. However, if the TV is in standby mode when ENERGY SAVING SWITCH is switched off (1), switching ENERGY SAVING SWITCH on (0) puts the TV back into standby mode only.  <ul style="list-style-type: none"> • When ENERGY SAVING SWITCH is switched off, you will not be able to perform such functions as saving clock settings, downloading EPGs, or updating software. |



- 4 SCENE**
(except for
KDL-46/40/37/32
W5720
W5730
W5740)

Press to display the “Scene Select” menu.
When you select the desired scene option, the optimum sound quality and picture quality for the selected scene are automatically set.
Press $\odot/\odot/\odot/\odot$ to select the scene option, then press \oplus .

Cinema: Delivers picture scenes just like those in a theatre-like atmosphere with dynamic sound.

Photo: Delivers picture scenes that authentically reproduces the texture and colour of a printed photo.

Sports: Delivers picture scenes that let you experience realistic picture and sound like those in a stadium.

Music: Delivers sound effects that let you experience dynamic and clear sound like that at a concert.

Game: Delivers picture scenes that let you enjoy your game-playing experience to the fullest with superb picture and sound quality.

Graphics: Delivers picture scenes that ease your prolonged monitor viewing experience and reduce fatigue by displaying clearer detailed pictures.

Auto: The optimum sound quality and picture quality are automatically set according to the input source, though there may not be any effect depending on the connected devices.



- When you set Theatre Mode (page 13) to on, the “Scene Select” setting switches to “Cinema” automatically.

- 5 AUDIO**

In analogue mode: Press to change the dual sound mode (page 37).

In digital mode: Press to change the language to be used for the programme currently being viewed (page 42).

- 6 $\odot/\odot/\odot/\odot$ (Info/Text reveal)**

Each time you press the button, the display changes as follows:

In digital mode: Details of the current programme \rightarrow Details of the next programme

In analogue mode: Current channel number and screen mode \rightarrow Clock information

In Text mode: Reveals hidden information (e.g. answers to a quiz) (page 16).

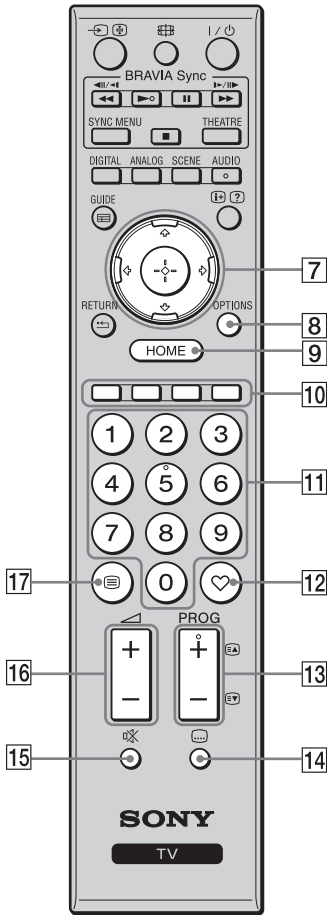

-
- 7** Press to move the on-screen cursor. Press to select/confirm the highlighted item. When playing a photo file: Press to pause/start a slideshow. Press to select the previous file. Press to select the next file. When playing a music/video file: Press to pause/start the playback. Press and hold to fast forward/fast reverse, then release the button at the point where you want to resume playback. Press to start playback from the beginning of the current file. Press to go to the next file.
-
- 8** **OPTIONS** Press to display a list that contains “Device Control” or shortcuts to some setting menus. Use the “Device Control” menu to operate equipment that is compatible with Control for HDMI. The listed options vary depending on the input source.
-
- 9** **HOME** Press to display the TV Home Menu (page 32).
-
- 10** **Coloured buttons** When the coloured buttons are available, an operation guide appears on the screen.
-
- 11** **Number buttons** **In TV mode:** Press to select channels. For channel numbers 10 and above, press the next digit quickly.
In Text mode: Press to enter a page number.
-
- 12** **(Favourite)** Press to display the Favourite List that you have specified (page 21).
-
- 13** **PROG +/-** **In TV mode:** Press to select the next (+) or previous (-) channel.
In Text mode: Press to select the next () or previous () page.
-
- 14** **(Subtitle setting)** Press to change the subtitle language (page 42) (in digital mode only).
-
- 15** **(Mute)** Press to mute the sound. Press again to restore the sound.

• In standby mode, if you want to turn on the TV without sound, press this button.
-
- 16** **(Volume)** Press to adjust the volume.
-
- 17** **(Text)** Press to display text information (page 15).
-

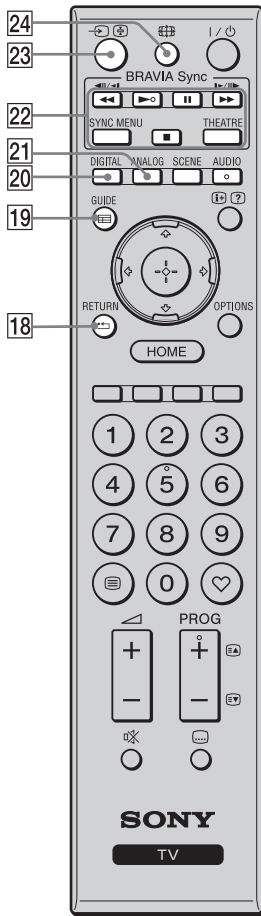

-
- 18** **RETURN** Press to return to the previous screen of the displayed menu.
When playing a photo/music/video file: Press to stop the playback. (The display returns to the file or folder list.)
-
- 19** **GUIDE** Press to display the Digital Electronic Programme Guide (EPG) (page 20).
-
- 20** **DIGITAL** Press to display the digital channel that was last viewed.
When viewing pictures from connected equipment: Press to return to normal TV mode.
-
- 21** **ANALOG** Press to display the analogue channel that was last viewed.
When viewing pictures from connected equipment: Press to return to normal TV mode.
-
- 22** **BRAVIA Sync** You can operate the BRAVIA Sync-compatible equipment that is connected to the TV.
SYNC MENU: Displays the menu of connected HDMI equipment. While viewing other input screens or TV programmes, “HDMI Device Selection” is displayed when the button is pressed.
THEATRE: You can set Theatre Mode to on or off. When Theatre Mode is set to on, the optimum sound quality (if the TV is connected with an audio system using an HDMI cable) and picture quality for film-based contents are automatically set.
- ✎**
- If you turn the TV off, Theatre Mode is also turned off.
 - When you change the “Scene Select” setting, Theatre Mode turns off automatically.
 - “Control for HDMI” (BRAVIA Sync) is only available with the connected Sony equipment that has the BRAVIA Sync or BRAVIA Theatre Sync logo or is compatible with Control for HDMI.
-
- 23** **(Input select/Text hold)** **In TV mode:** Press to display a list of inputs.
In Text mode: Press to hold the current page.
-
- 24** **(Screen mode)** Press to change the screen format (page 16).
-

Indicators

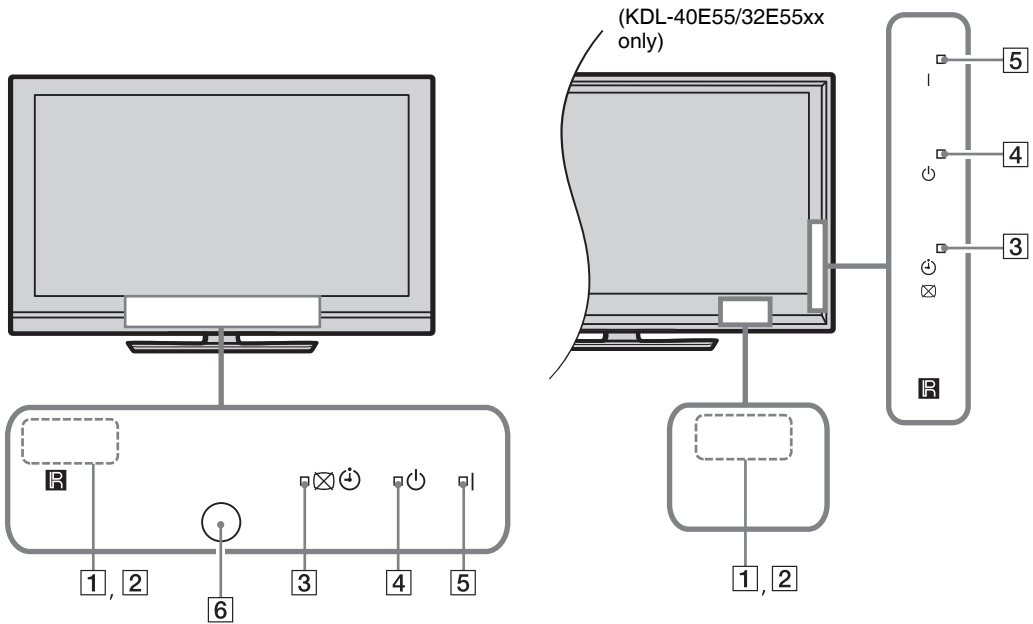

| Indicator | Description |
|--|--|
| 1 Light sensor | Do not put anything over the sensor, doing so may affect its function (page 34). |
| 2 Remote control sensor | Receives signals from the remote. Do not put anything over the sensor. The sensor may not work properly. |
| 3 (Picture Off / Timer) | Lights up in green when you select “Picture Off” (page 33). Lights up in orange when you set the timer (page 20, 33). |
| 4 (Standby) | Lights up in red when the TV is in standby mode. |
| 5 I (Power) | Lights up in green when the TV is on. |
| 6 Presence Sensor (KDL-46WE5/ 40WE5xx only) | Do not put anything over the sensor, doing so may affect its function (page 33). |

About the operation guide on the TV screen

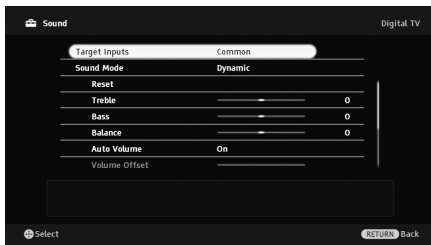

Operation Guide

Example: Press or RETURN (see [7](#) (page 12) or [18](#) (page 13)).

The operation guide provides help on how to operate the TV using the remote, and is displayed at the bottom of the screen. Use the remote buttons shown on the operation guide.

Watching TV

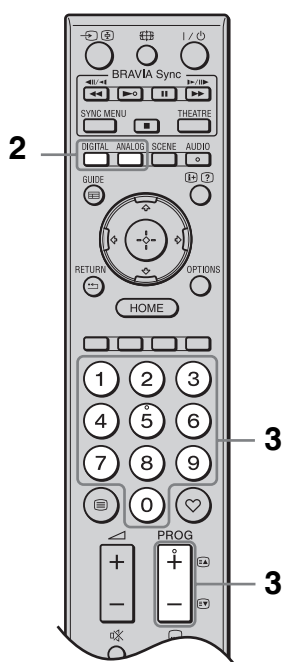
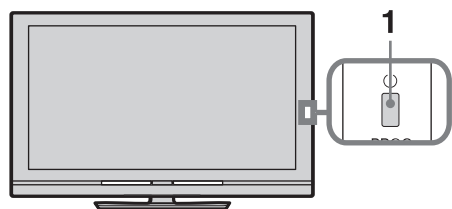

- 1 Press on the TV to turn on the TV.

When the TV cannot be turned on, switch **ENERGY SAVING SWITCH** on (page 10) (KDL-46WE5/40WE5xx only).

When the TV is in standby mode (the (standby) indicator on the TV front panel is red), press on the remote to turn on the TV.
- 2 Press **DIGITAL** to switch to digital mode, or press **ANALOG** to switch to analogue mode.

The available channels vary depending on the mode.

- 3 Press the number buttons or **PROG +/-** to select a TV channel.

To select a digital programme using the Digital Electronic Programme Guide (EPG) (page 20).

In digital mode

An information banner appears briefly. The following icons may be indicated on the banner.

- : Interactive service is available (MHEG Digital Text)
- : Interactive service (MHEG Digital Text) is currently disabled
- : Radio service
- : Scrambled/Subscription service
- : Multiple audio languages available
- : Subtitles available
- : Subtitles available for the hearing impaired
- : Recommended minimum age for current programme (ages from 4 to 18)
- : Parental lock

To access Digital Text

Many broadcasters provide a Digital Text service. Digital Text offers graphically rich contents, compared to Analogue Text. Select a digital channel which provides Digital Text, then press .

When a broadcaster provides a dedicated Digital Text channel, select this channel to access Digital Text.

To navigate through Digital Text, follow the instructions on the screen.



To exit Digital Text, press **RETURN**.

To move around, press .



To select items, press and the number buttons.

To access shortcuts, press the coloured buttons.

To access Analogue Text

In analogue mode, press . Each time you press , the display changes cyclically as follows:





Text and TV picture → Text → No Text (exit the Text service)

To select a page, press the number buttons or /.

To hold a page, press .

To reveal hidden information, press .



- You can also jump directly to a page by selecting the page number displayed on the screen. Press  and / to select the page number, then press .
- When four coloured items appear at the bottom of the Text page, you can access pages quickly and easily (FasText). Press the corresponding coloured button to access the page.

To change the Screen Format manually

Press  repeatedly to select the desired Screen Format.

Smart*

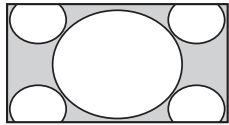

Enlarges the centre portion of the picture. The left and right edges of the picture are stretched to fill the 16:9 screen.

4:3

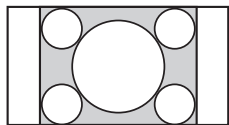

Displays the 4:3 picture in its original size. Side bars are shown to fill the 16:9 screen.

Wide

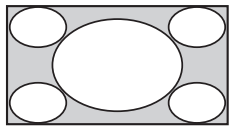

Stretches the 4:3 picture horizontally, to fill the 16:9 screen.

Zoom*

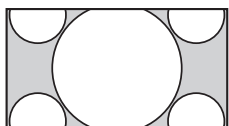

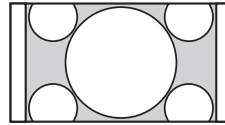

Displays the cinemascopic (letter box format) picture in the correct proportion.

14:9*



Displays the 14:9 picture in the correct proportion. As a result, side bars are shown on the screen.

- * Parts of the top and bottom of the picture may be cut off. You can adjust the vertical position of the picture. Press / to move the picture up or down (e.g. to read subtitles).



- When you select “Smart”, some characters and/or letters at the top and the bottom of the picture may not be visible. In such a case, adjust “Vertical Size” in the “Screen” menu (page 37).



- When “Auto Format” (page 37) is set to “On”, the TV automatically selects the best mode to suit the broadcast.
- If 720p, 1080i or 1080p source pictures are displayed with black borders on the screen edges, select “Smart” or “Zoom” to adjust the pictures.

Using GUIDE Plus+™ System* and the Digital Electronic Programme Guide (EPG)**

* Condition you can set-up this feature:

- you can receive digital broadcasting.
- when “Antenna” is selected in “5: Performing the initial Set-up”.

** This function may not be available in some countries/regions.

GUIDE Plus+ works with full functionality only if GUIDE Plus+ data is available by digital feed. Please check the GUIDE Plus+ website whether or not DTT GUIDE Plus+ is already available in your country.



When you use GUIDE Plus+, it is recommended that you turn off your TV by using the standby button on the remote, not the power button on your TV, in order to update the programme information.

Using GUIDE Plus+

Use GUIDE Plus+ System to find the show that you want to watch. The feature allows you to search for shows by programme categories and by keyword. The GUIDE Plus+ programme provides up to eight days of TV programming information. Be sure to complete the initial Set-up (page 6) to use this service.

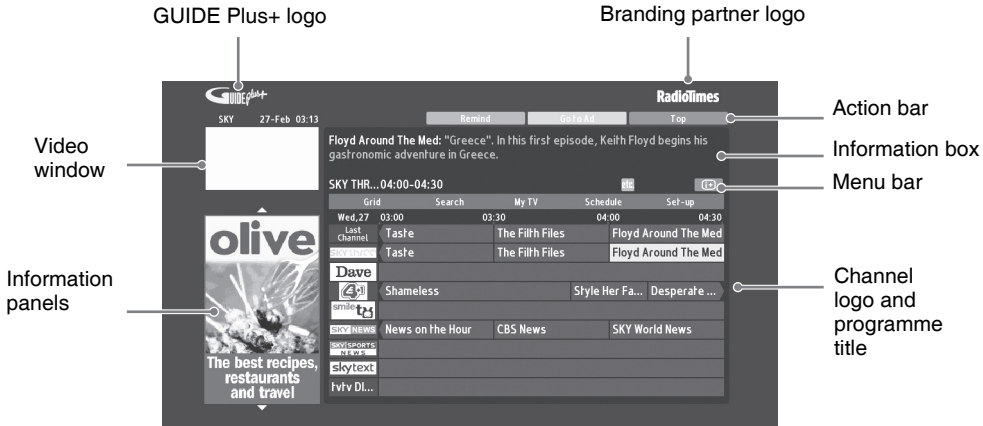

GUIDE Plus+ System Components











- Image shown above varies depending on country/region.
- Information panels is not Sony provided, adverts from Branding Partner.
- The function of action bar varies with cursor location and when in settings.

1 Press **GUIDE**.

2 Perform the desired operation as shown in the following table or displayed on the screen.

| To | Do this |
|--|---|
| View a programme | <p>Press /⇄/⇄/⇄ to select a programme, then press .</p>  <ul style="list-style-type: none"> • The programme information will appear in the information box. • Press to access the extended information box for a long synopsis. • You can use PROG +/- to page up/down through the listings. <p>Press BRAVIA Sync /⇄/⇄ to go to the next day or one day back.</p> |
| Turn off the TV Guide | Press GUIDE to exit TV Guide. |
| Set a programme to be displayed automatically on the screen when it starts – Reminder | <p>Press /⇄/⇄/⇄ to select a future programme you want to watch, then press the green button.</p>  <ul style="list-style-type: none"> • To cancel a reminder, press the red button when “Reminder” is highlighted or use “Schedule” on the menu bar. • If you switch the TV to standby mode, it will automatically turn itself on when the programme is about to start. |
| Menu bar | <p>Press repeatedly to access the menu bar. Press /⇄ to select area. (“Grid”, “Search”, “My TV”, “Schedule” and “Set-up”) You can view a programme or set a reminder in “Grid” area.</p> |
| Search a programme – Search | <p>You can quickly and easily find something of interest to watch or to set a reminder by category (e.g. Sport) or subcategory (e.g. Football) of a programme.</p> <ol style="list-style-type: none"> 1 Highlight “Search” on the menu bar, then, press only one time. 2 Press /⇄/⇄/⇄ to select a category or subcategory, then press . |
| Search your own keyword – My Choice | <p>In addition to the standard categories and sub-categories, you can set your own search keywords.</p> <ol style="list-style-type: none"> 1 Highlight “My Choice” in the “Search” area on the menu bar. 2 Press yellow button to add a keyword, then the virtual keyboard appears. 3 Use the virtual keyboard to enter your keyword. 4 Confirm with the green button. 5 Your personal keyword appears in the “My Choice”. 6 Select your keyword and press to start a search according to your personal keyword. |

| To | Do this |
|--|--|
| Set a Profile and receive recommendations according to your preferences – My TV | <p>The “My TV” area allows you to set up a personal profile. You can define a personal profile by channels, categories and/or by keywords.</p> <p>The “My TV” area is making recommendations to you to quickly and easily find something of interest to watch or to set a reminder.</p> <p>How to set your profile:</p> <ol style="list-style-type: none"> 1 Highlight “My TV” on the menu bar, press the green button to set your profile. 2 Press  to select channels, categories or keywords. 3 Press the yellow button to add a channel, a category or a keyword to your profile. 4 Press  to select a channel, a category or a keyword, then press . 5 Repeat step 2 to 4 to add more items. 6 Press  to activate your profile. <p></p> <ul style="list-style-type: none"> • You can delete or edit with the red and green buttons. |
| Delete and edit reminder – Schedule | <ol style="list-style-type: none"> 1 Highlight “Schedule” on the menu bar. 2 Press  to delete or edit with the red and green buttons. <p></p> <ul style="list-style-type: none"> • When no reminder is set, “No programmes” is displayed. Press  to highlight “Frequency” (e.g. weekly) or “Timing” (e.g. reminder timing: 10 min early), you can change this settings by pressing colour buttons. |
| Configure the GUIDE Plus+ System according to your personal situation – Set-up | <ol style="list-style-type: none"> 1 Highlight “Set-up” on menu bar. 2 Press  for you to select below items you want to configure. <ul style="list-style-type: none"> “Personal Preferences”: You can change the on screen language, change reminder timing and set overnight download. “Start Installation Sequence”: This feature provides an easy way to restart your installation from scratch. This will delete all your current TV listing data. “Manual Data Download”: Update your TV listings immediately. If the TV is switched off during several days, TV listings will not be updated automatically. In this case, use this feature to update TV listings. “GUIDE Plus+ System Information:” screen: Display GUIDE Plus+ System information. This screen is providing several values that are helpful for troubleshooting. |

Using the Digital Electronic Programme Guide (EPG)

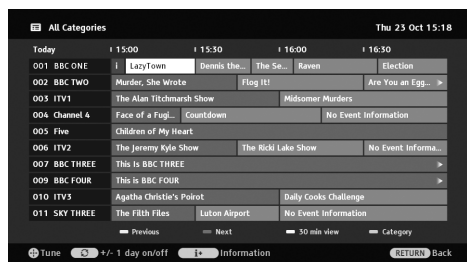

- 1 In digital mode, press **GUIDE**.
- 2 Perform the desired operation as shown in the following table or displayed on the screen.

| To | Do this |
|--|--|
| View a programme | Press $\uparrow/\downarrow/\leftarrow/\rightarrow$ to select a programme, then press \oplus . |
| Turn off the EPG | Press GUIDE . |
| Sort programme information by category – Category list | <ol style="list-style-type: none"> 1 Press the blue button. 2 Press \uparrow/\downarrow to select a category, then press \oplus. Category name (e.g. “News”) contains all channels corresponding to the selected category. |
| Set a programme to be displayed automatically on the screen when it starts – Reminder | <ol style="list-style-type: none"> 1 Press $\uparrow/\downarrow/\leftarrow/\rightarrow$ to select a future programme you want to display, then press \oplus. 2 Press \uparrow/\downarrow to select “Reminder”, then press \oplus. A \ominus symbol appears next to the programme’s information. The $\boxtimes \ominus$ indicator on the TV front panel lights up in orange. <p> • If you switch the TV to standby mode, the TV will automatically turn on when the programme starts.</p> |
| Cancel a reminder – Cancel Timer | <ol style="list-style-type: none"> 1 Press \oplus. 2 Press \uparrow/\downarrow to select “Timer list”, then press \oplus. 3 Press \uparrow/\downarrow to select the programme you want to cancel, then press \oplus. 4 Press \uparrow/\downarrow to select “Cancel Timer”, then press \oplus. A display appears to confirm that you want to cancel the programme. 5 Press \leftarrow/\rightarrow to select “Yes”, then press \oplus. |

Using the Favourite List

Analogue Favourites

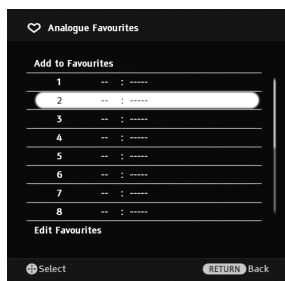

Analogue Favourite List

The Favourite feature lets you select programmes from a list of up to 16 favourite channels that you specify.

- 1 In analogue mode, press ♥.
- 2 Perform the desired operation as shown in the following table or displayed on the screen.

| To | Do this |
|---|--|
| Watch a channel | Press ⊕. |
| Turn off the Favourite list | Press ♥. |
| Add a current channel to the Favourite list | Press ⇄/⇄ to select “Add to Favourites”, then press ⊕. |
| Remove a channel from the Favourite list | <ol style="list-style-type: none"> 1 Press ⇄/⇄ to select “Edit Favourites”, then press ⊕. The “Favourite Set-up” screen appears. 2 Press ⇄/⇄ to select the channel number, then press ⊕. 3 Press ⇄/⇄ to select “- -”, then press ⊕. |

Digital Favourites



Digital Favourite List

You can specify up to four of your favourite channel lists.

- 1 In digital mode, press ♥.
- 2 Perform the desired operation as shown in the following table or displayed on the screen.

| To | Do this |
|--|--|
| Add or remove channels in a Favourite list | <ol style="list-style-type: none"> 1 Press the blue button. Go to step 2 when you add channels for the first time or the Favourite list is empty. 2 Press the yellow button to select the Favourite list to edit. 3 Press ⇄/⇄/⇄/⇄ to select the channel to add or remove, then press ⊕. |
| Watch a channel | <ol style="list-style-type: none"> 1 Press the yellow button to select a Favourite list. 2 Press ⇄/⇄ to select a channel, then press ⊕. |
| Remove all channels from a Favourite list | <ol style="list-style-type: none"> 1 Press the blue button. 2 Press the yellow button to select the Favourite list to edit. 3 Press the blue button. 4 Press ⇄/⇄ to select “Yes”, then press ⊕. |

Using Optional Equipment

Connecting Optional Equipment

You can connect a wide range of optional equipment to your TV.

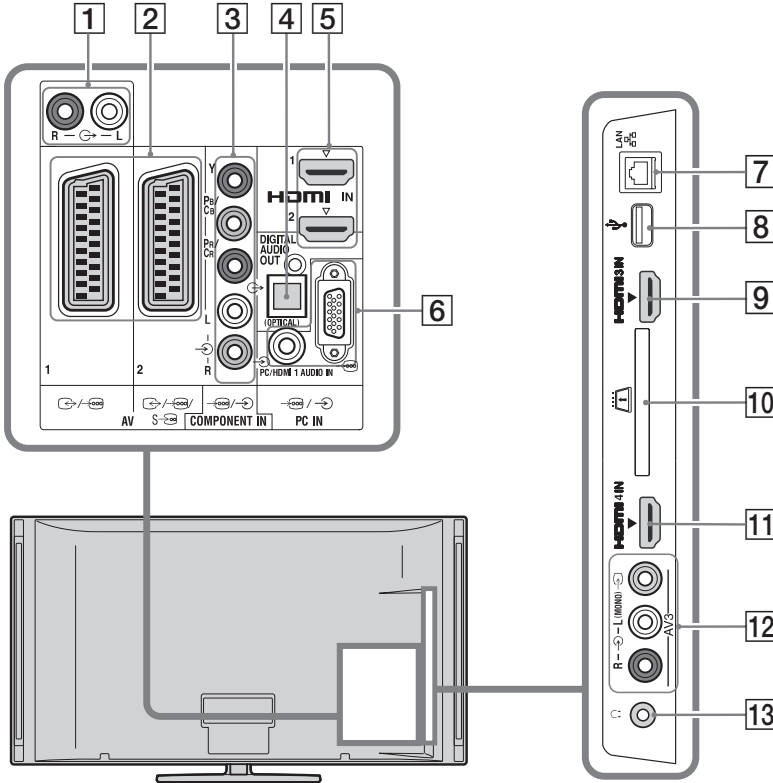

Connecting audio-video equipment (quality order, high to low)

| Connect to | Connect with | Description |
|---|-------------------|---|
| [5], [9], [11] HDMI IN 1, 2, 3, or 4 | HDMI cable | <p>Digital video and audio signals are input from the connected equipment.</p> <p>In addition, when you connect the equipment that is compatible with Control for HDMI, communication with the connected equipment is supported (page 40).</p> <p>If the equipment has a DVI socket/jack, connect the DVI socket/jack to the HDMI IN 1 socket/jack through a DVI - HDMI adaptor interface (not supplied), and connect the equipment's audio out sockets/jacks to the audio in sockets/jacks in the HDMI IN 1 sockets/jacks.</p> <p></p> <ul style="list-style-type: none"> • Be sure to use only an authorized HDMI cable bearing the HDMI logo. We recommend that you use a Sony HDMI cable (high speed type). • When connecting an audio system that is compatible with Control for HDMI, be sure to also connect it to the DIGITAL AUDIO OUT (OPTICAL) socket/jack. |

| Connect to | Connect with | Description |
|---|---|--|
| 3 COMPONENT IN | Component video cable, audio cable | |
| 2 AV1, AV2 | SCART cable | When you connect a decoder, the TV tuner outputs scrambled signals to the decoder, and the decoder unscrambles the signals before outputting them. |
| 12 AV3, and AV3 | Composite video cable | When connecting a mono equipment, connect to the AV3 L socket. |

Connecting audio/portable equipment



| Connect to | Connect with | Description |
|---|----------------------------|---|
| 1 | Audio cable | You can listen to TV sound on the connected Hi-Fi audio equipment. |
| 4 DIGITAL AUDIO OUT (OPTICAL) | Optical audio cable | |
| 8 USB | USB cable | You can enjoy photo/music/video files stored in a Sony digital still camera or camcorder (page 25). |

Connecting other equipment

| Connect to | Connect with | Description |
|--|--|--|
| 6 PC IN | PC cable with ferrites, audio cable | It is recommended to use a PC cable with ferrites, such as the “Connector, D-sub 15” (ref. 1-793-504-11, available in Sony Service Centre), or an equivalent. |
| 7 LAN | LAN cable | You can enjoy contents stored in DLNA-compatible devices via a network (page 28). |
| 10 CAM (Conditional Access Module) | | Provides access to pay TV services. For details, refer to the instruction manual supplied with your CAM. To use the CAM, remove the “dummy” card from the CAM slot, then turn off the TV and insert your CAM card into the slot. When you are not using the CAM, we recommend that you keep the “dummy” card in the CAM slot. • CAM is not supported in some countries/areas. Check with your authorised dealer. |
| 13 Headphones | | You can listen to TV sound through headphones. |

Viewing Pictures from Connected Equipment

Turn on the connected equipment, then perform the following operation.

- 1 Press .
- 2 Press  to select the desired input source, then press .

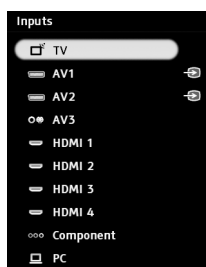

For equipment connected to the scart sockets using a fully-wired 21-pin scart lead

Start playback on the connected equipment. The picture from the connected equipment appears on the screen.

For an auto-tuned VCR



In analogue mode, press **PROG +/-** or the number buttons, to select the video channel.

To view two pictures simultaneously – PAP (Picture and Picture)

You can view two pictures (external input and TV programme) on the screen simultaneously.



- This function is not available for a PC input.



- 1 Press **OPTIONS**.
 - 2 Press  to select “PAP”, then press .
- The picture from the connected equipment is displayed on the left, and the TV programme is displayed on the right.
- 3 Press the number buttons or **PROG +/-** to select the TV channel.

To return to single picture mode

Press  **RETURN**.

To view two pictures simultaneously – PIP (Picture in Picture)

You can view two pictures (external input and TV programme) on the screen simultaneously.

- 1 Press **OPTIONS**.
- 2 Press  to select “PIP”, then press .

The picture from the connected PC is displayed in full size, and the TV programme is displayed in the small screen.



You can use  to change the position of the TV programme screen.

- 3 Press the number buttons or **PROG +/-** to select a TV channel.

To return to single picture mode

Press  **RETURN**.



- You can switch the audible picture by pressing  .

Playing back Photo/Music/Video via USB

You can enjoy photo/music/video files stored in a Sony digital still camera or camcorder through a USB cable or USB storage device on your TV.

- 1 Connect a supported USB device to the TV.
- 2 Press **HOME**.
- 3 Press \leftarrow/\rightarrow to select “Photo”, “Music”, or “Video”.

- 4 Press \uparrow/\downarrow to select a USB device, then press \oplus .

The file or folder list appears.

To display a thumbnail list, press the yellow button while the list is displayed.

- 5 Press \uparrow/\downarrow to select a file or folder, then press \oplus .

When you select a folder, select a file, then press \oplus .

Playback starts.

Photo Playback Auto Start

The TV automatically starts photo playback when the TV is turned on and a digital still camera or other device storing photo files is connected to the USB port then turned on (page 39).



- While the TV is accessing the data on the USB device, observe the following:
 - Do not turn off the TV or connected USB device.
 - Do not disconnect the USB cable.
 - Do not remove the USB device.
 The data on the USB device may be damaged.
- Sony will not be held liable for any damage to, or loss of, data on the recording media due to a malfunction of any connected devices or the TV.
- Playback does not start automatically if the TV is turned on after connecting the digital still camera or other device to the USB port.
- You can register the background music to be played during a slideshow using  Photo by pressing **OPTIONS**, then select “Add to Slideshow” while playing back music.
- USB playback is supported for the following photo file formats:
 - JPEG (JPEG format files with the extension “.jpg” and conforming to DCF 2.0 or Exif 2.21)

- RAW (ARW/ARW 2.0 format files with the extension “.arw”. For preview only.)
- USB playback is supported for the following music file format:
 - MP3 (files with the extension “.mp3” that have not been copyrighted)
- USB playback is supported for the following video file format:
 - MPEG1 (files with the extension “.mpg”)
- The file name and folder name support only English.
- When you connect a Sony digital still camera, set the camera’s USB connection mode to Auto or “Mass Storage”. For more information about USB connection mode, refer to the instructions supplied with your digital camera.
- Check the website below for updated information about compatible USB devices.
<http://support.sony-europe.com/TV/compatibility/>

To display a photograph — Picture Frame

You can display a photograph on the screen for a selected period of time. After that period, the TV automatically switches itself into standby mode.

- 1 Select a photograph.

You can select a photograph from the connected USB device or preset picture folder. For details on selecting a photograph (page 25).

- 2 Press **OPTIONS** while the selected photograph is displayed, then press \uparrow/\downarrow to select “Picture Frame Image” and press \oplus .

- 3 Press \leftarrow **RETURN** repeatedly to return to the Home Menu.

- 4 Press \leftarrow/\rightarrow to select “Photo”, then select “Picture Frame” and press \oplus .

The TV is switched to Picture Frame mode, and the selected photograph is displayed on the screen.

To set the duration of displaying a photograph

Press **OPTIONS**, then select “Duration” and press \oplus . Then, select the duration, and press \oplus .

The counter appears on the screen.

To return to the XMB™

Press \leftarrow **RETURN**.



- If the photograph is selected from a USB device, it must remain connected to the TV.
- If “Sleep Timer” is activated, the TV automatically will switch into standby mode.

To display a photograph with the location on the map

When using a digital still camera with GPS function, it is possible to display a photograph with a map of the location where the photograph was taken using a function of GPS for recording longitude and latitude. Because map information is downloaded from the Internet online map service, the network connection must be required and the TV has to be connected to the network (page 28).

- 1 Select a photograph (page 25).
- 2 Press the green/red buttons to zoom in/out on the map.

To change the display position of the map on the TV screen, press the blue button repeatedly.



- Because the Internet online map service is provided by a third party, service may be changed or terminated without prior notification to the user.
- The position indicated on the map may differ depending on the digital still camera.
- Only a large-scale map that cannot be zoomed in or out is displayed if the TV is not connected to the Internet or the Internet online map service is terminated.



- A map can be displayed in the case of photograph’s Exif data includes a date information, and the associated longitude and latitude information (“Log files”) has been recorded using a Sony GPS unit. Follow the procedure described below.
- 1 Connect the GPS unit to the USB port.
 - 2 Press **HOME**.
 - 3 Press \leftarrow/\rightarrow to select “Photo”.
 - 4 Press \uparrow/\downarrow to select the GPS unit, then press \oplus .

- 5 Select the following items using \uparrow/\downarrow , then set them using \leftarrow/\rightarrow .
 - Time Zone
 - DST
- 6 Select “OK”, then press \oplus .
The GPS log files are loaded.
- 7 Disconnect the GPS unit and connect the device on which the photograph is stored.
- 8 Select a photograph (page 25).
- 9 Press the green/red buttons to zoom in/out on the map.

Using BRAVIA Sync with Control for HDMI

The Control for HDMI function enables the TV to communicate with the connected equipment that is compatible with the function, using HDMI CEC (Consumer Electronics Control).

For example, by connecting Sony equipment that is compatible with Control for HDMI (with HDMI cables), you can control them together.

Be sure to connect the equipment correctly, and make the necessary settings.

Control for HDMI

- Automatically turns the connected equipment off when you switch the TV to standby mode using the remote.
- Automatically turns the TV on and switches the input to the connected equipment when the equipment starts to play.
- If you turn on a connected audio system while the TV is on, the sound output switches from the TV speaker to the audio system.
- Adjusts the volume (◀ +/-) and mutes the sound (⊗) of a connected audio system.
- You can operate the connected Sony equipment that has the BRAVIA Sync logo by the TV remote by pressing:
 - ◀▶/⏪/⏩/■ to operate the connected equipment directly.
 - **SYNC MENU** to display the menu of the connected HDMI equipment on the screen. After displaying the menu, you can operate the menu screen by using ◀/▶/⏪/⏩, ⊕, colour buttons, and **RETURN**.
 - **OPTIONS** to display “Device Control”, then select options from “Options” and “Content List” to operate the equipment.
 - Refer to the instruction manual of the equipment for available control.
- If “Control for HDMI” of the TV is set to “On”, “Control for HDMI” of the connected equipment is also automatically switched to “On”.

To connect the equipment that is compatible with Control for HDMI

Connect the compatible equipment and the TV with an HDMI cable. When connecting an audio system, be sure to also connect the DIGITAL AUDIO OUT (OPTICAL) jack of the TV and the audio system using an optical audio cable (page 22).

To make the Control for HDMI settings

The Control for HDMI settings must be set on both the TV side and connected equipment side. See “HDMI Set-up” (page 40) for the TV side settings. For settings on the connected equipment, refer to the operating instructions for that equipment.

Using Home Network Features

With this TV, you can enjoy contents stored in DLNA-compatible devices on the home network.

Devices that store and provide contents, such as photo/music/video files, are called "Server". The TV receives the photo/music/video files from the server via the network, and you can enjoy them on the TV even in other rooms.

To enjoy the home network, a DLNA-compatible device (VAIO, Cyber-shot, etc.) is necessary as a server.

In addition, when you connect your TV to the Internet, you can enjoy displaying a photograph that shows its location on the map (page 26), or enjoy "AppliCast" while watching a TV programme (page 29).



- You will need to contract with an Internet service provider to connect to the Internet.

Connecting to the Network

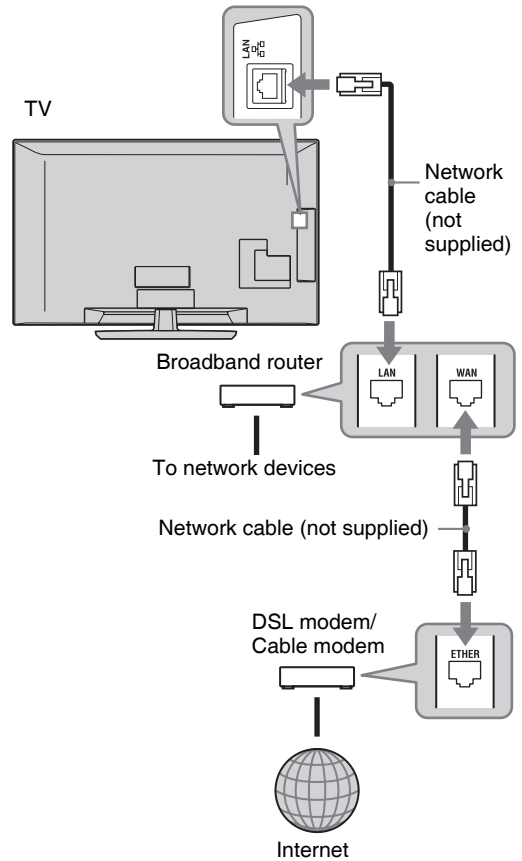

Enjoying AppliCast

While watching TV, you can display variety of information on the edge of TV screen by using Widgets (i.e. mini-applications).

Many Widgets retrieve information from the Internet.

To Use Widgets

Widgets can be displayed by selecting from the Home Menu. While the Widget is displayed, you can add to your Widget list so that it would be registered to be automatically displayed next time when you launch "AppliCast". Some Widgets allow you to save settings to provide you with the preferred information.

- 1 Press **HOME**.
- 2 Press \leftarrow/\rightarrow to select "Network".
- 3 Press \uparrow/\downarrow to select the desired Widget to be displayed or simply select "AppliCast" icon to display your preferred list of Widgets.
- 4 Follow the instruction on the Widget.

To return to single picture mode

Press  **RETURN**.

To Add or remove Widgets in AppliCast

You can add to or remove from the Widget list.

From Widget:

- 5 While you are displaying the Widget, press **OPTIONS**.
- 6 Select "Add to AppliCast" or "Remove from AppliCast".
Up to 30 Widgets can be registered in "AppliCast".

From "Network" in the Home Menu:

- 7 Follow STEP1-2 above.
- 8 Press \uparrow/\downarrow to select the desired Widget, then press **OPTIONS**.
- 9 Follow STEP6.



- There are three Widgets already in the set that don't require internet connection. They are "How to use AppliCast", "Analogue Clock", and "Calendar".

- AppliCast Widgets stored in the USB Mass Storage Device connected to BRAVIA. The Widget icons should appear under USB icon under "Network" in the Home Menu.



- MAC address and IP address are transmitted automatically from the TV to servers while internet connection is available.
The servers are under the control of Sony and MAC address will never be transmitted to the servers controlled by the other parties.
- Widgets may be changed or terminated without prior notification to the user.

Enjoying Photo/Music/Video Files via the Network

You can enjoy photo/music/video files on the server easily by selecting an icon on the Home Menu of the TV.

- 1 Press **HOME**.
- 2 Press \leftarrow/\rightarrow to select “Photo”, “Music”, or “Video”.
- 3 Press \uparrow/\downarrow to select a server, then press \oplus .

The file or folder list appears.

To display the thumbnail list, press the yellow button while the list is displayed.

When the server cannot be found

See “Checking the Network Connection” (page 31) and “Adjusting the Server Display Settings” (page 31).

- 4 Press \uparrow/\downarrow to select a file or folder, then press \oplus .



When you select a folder, select a file, then press \oplus .

Playback starts.



- A map can be displayed with a photograph in the case of longitude and latitude information has been recorded to photograph’s Exif data (page 26).



- Depending on the network device, it may be necessary to register the TV with the network device.
- Picture quality may appear coarse when using  Photo because images may be enlarged depending on the file. Also, images may not fill the entire screen depending on the image size and aspect ratio.
- Some photo files may take some time to be displayed when using  Photo.
- To play files that are received from a network device, they need to conform to one of the following file formats.
 - Still images: JPEG format
 - Music: MP3 format or linear PCM format
 - Video: The following file formats stored on the sever: AVCHD, HDV, MPEG2-PS (which in some cases may not be able to be played)Depending on the network device, the file format may be converted before transfer. In such cases, the file format resulting after conversion is used for playback. For details, refer to the instruction

manual for the network device being used.

Even files conforming to one of the file formats given above cannot be played in some cases.

- The file name and folder name support only English.

To enjoy photographs, music and videos on the TV screen by operating devices

– Renderer

Renderer is a feature for playing photo, music and video files stored in network devices (digital still cameras, mobile phones, etc.) on the TV by operating the controller device in question. To use this feature, a renderer-compatible device such as a digital still camera or mobile phone is required as the controller. Refer as well to the instruction manual supplied with the controller.

- 1 Set “Renderer Function”, “Renderer Access Control” and “Renderer Set-up” in “Network Settings” if necessary (page 44).
- 2 Play the file selected using the controller on the TV.

The file is played on the TV over the connected network.

Use the controller or the TV’s remote to perform operations during playback.



- You can register the background music to be played during a slideshow using  Photo. While playing back music, press **OPTIONS**, then select “Add to Slideshow”.

Checking the Network Connection

Enter the respective (alphanumeric) values for your router. The items that need to be set may differ, depending on the Internet service provider or the router. For details, refer to the instruction manuals that have been provided by your Internet service provider or supplied with the router.

- 1 Press **HOME**.
- 2 Press \leftarrow to select “Settings”.
- 3 Press \updownarrow to select “Network Settings”, then press \oplus .
- 4 Select “Network”, then press \oplus .
- 5 Select “IP Address Settings”, then press \oplus .
- 6 Select an item, and press \oplus .

When you select “DHCP (DNS automatic)”

Go to step 7.

When you select “DHCP (DNS manual)”

Set “Primary DNS”/“Secondary DNS” using \updownarrow/\rightarrow and the number buttons.

When you select “Manual”

Set the following items using \updownarrow/\rightarrow and the number buttons.

- IP Address
- Subnet Mask
- Default Gateway
- Primary DNS/Secondary DNS

If your ISP has a specific proxy server setting

Press **OPTIONS**, then press \updownarrow to select “Proxy Set-up” and press \oplus . Then enter the settings.

- 7 Press \oplus .
- 8 Press \rightarrow to select “Test”, then press \oplus .
- 9 Press \leftarrow/\rightarrow to select “Yes”, then press \oplus .

The network diagnostic starts.

When the message “Connection successful.” appears, press **RETURN** repeatedly to exit.



If “Connection successful.” does not appear, see “Troubleshooting” (page 52).

Adjusting the Server Display Settings

You can select home network servers to be displayed on the Home Menu.

Up to 10 servers can be displayed on the Home Menu automatically.

- 1 Set the server to allow connections from the TV.
For details on settings on the server, refer to the Operating Instructions supplied with the server.
- 2 Press **HOME**.
- 3 Press \leftarrow/\rightarrow to select “Settings”.
- 4 Press \updownarrow to select “Network Settings”, then press \oplus .
- 5 Select “Server Display Settings”, then press \oplus .
- 6 Select the server you want to display on the Home Menu, then press \oplus .
- 7 Select “Yes”, then press \oplus .

If you cannot connect to your home network

The TV can check if the server is being correctly recognised.

- 1 Press **HOME**.
- 2 Press \leftarrow/\rightarrow to select “Settings”.
- 3 Press \updownarrow to select “Network Settings”, then press \oplus .
- 4 Select “Server Diagnostics”, then press \oplus .
- 5 Select “Yes”, then press \oplus .

The server diagnostic starts.

When the server diagnostic is complete, the diagnostic result list appears.

- 6 Select the server you want to confirm, then press \oplus .

The diagnostic results of the selected server appear.

If the diagnostic results indicate a failure, look up the possible causes and what to do, and check connections and settings. For details, see “Troubleshooting” (page 52).

Using Menu Functions









Navigating through TV Home Menu on XMB™

The XMB™ (XrossMediaBar) is a menu of BRAVIA features and input sources displayed on the TV screen. The XMB™ is an easy way to select programming and adjust settings on your BRAVIA TV.

- 1 Press **HOME** to display the XMB™.



- 2 Press \leftarrow/\rightarrow to select the category.

| Media category icon | Description |
|--|---|
|  Settings | You can make advanced settings and adjustments (page 33). |
|  Photo | You can enjoy photo files via USB devices or the network (page 25, 30). |
|  Music | You can enjoy music files via USB devices or the network (page 25, 30). |
|  Video | You can enjoy video files via USB devices or the network (page 25, 30). |
|  Digital | You can select a digital channel, Digital Favourite list (page 21), or GUIDE Plus+™ System and the Digital Electronic Programme Guide (EPG) (page 17, 20). |
|  Analogue | You can select an analogue channel or Analogue Favourite list (page 21). To hide the list of analogue channels, set “Programme List Display” to “Off” (page 40). |
|  External Inputs | You can select equipment connected to the TV. To assign a label to an external input, see “AV Preset” (page 39). |
|  Network | You can enjoy “AppliCast” (page 29). |

- 3 Press \uparrow/\downarrow to select the item, then press \oplus .
- 4 Follow the instructions on the screen.
- 5 Press **HOME** to exit.



- The options you can adjust vary depending on the situation.
- Unavailable options are greyed out or not displayed.

TV Settings Menu



System Update

You can update the TV system using USB memory. Obtain information from the website below.
<http://support.sony-europe.com/TV/>



Instruction Manual

Displays the instruction manual on the screen (except for KDL-52V55/56xx, 46V55/56xx, 40V55/56xx, 37V55/56xx, 32V55/56xx).



- The illustration of the Remote commander on the screen instruction manual may vary for KDL-46/40/37/32W5720/5730/5740.



BRAVIA Tips

Introduces how to enjoy the TV (except for KDL-52V55/56xx, 46V55/56xx, 40V55/56xx, 37V55/56xx, 32V55/56xx).



Clock/Timers

| | |
|--------------------------|---|
| Sleep Timer | Sets the TV to automatically switch to standby mode after a certain amount of time. When “Sleep Timer” is activated, the ⏻ (Timer) indicator on the TV front panel lights up in orange.  <ul style="list-style-type: none">• When you turn off the TV and turn it on again, “Sleep Timer” is reset to “Off”. |
| On Timer | Sets the TV to automatically turn on from standby mode. |
| Auto Clock Update | Switches to digital mode and obtains the time. |



Eco



| | |
|--|---|
| Reset | Resets all the “Eco” settings to the factory settings. |
| Power Saving | Reduces power consumption of the TV by adjusting the backlight. When you select “Picture Off”, the picture is switched off, and the ⓧ Picture Off indicator on the TV front panel lights up in green. The sound remains unchanged. |
| Presence Sensor (KDL-46WE5/40WE5xx only) | When no presence is detected in front of TV, the TV switches to picture off mode automatically. Additionally, when no presence is detected after 10 minutes in picture off mode, the TV switches to standby mode. In this mode, power consumption is reduced by about 70 %. |
| Idle TV Standby | Turns the TV off after it has been kept idle for the preset length of time. |
| PC Power Management | Switches the TV to standby mode when the TV receives no signal from the PC input source for 30 seconds. |

| | |
|---------------------|---|
| Light Sensor | <p>Automatically optimises the picture settings according to the ambient light in the room.</p> <p></p> <ul style="list-style-type: none"> Do not put anything over the sensor, doing so may affect its function. Check the position of the sensor (page 14). |
|---------------------|---|



Picture

| | |
|----------------------|---|
| Target Inputs | <p>Allows you to select whether to use the common settings or to make custom settings for the input you are currently viewing.</p> <p>Common Applies common settings to all inputs in which “Target Inputs” is set to “Common”.</p> <p>Name of current input (e.g. AV1) Allows you to make custom settings for the input.</p> |
| Picture Mode | <p>Sets a picture mode. The options that can be selected differ depending on the scene select settings.</p> <p>Vivid Enhances picture contrast and sharpness.</p> <p>Standard For standard pictures. Recommended for home entertainment.</p> <p>Custom Allows you to store your preferred settings.</p> <p>Cinema For viewing film-based content. Most suitable when viewing the TV in a theatre-like environment.</p> <p>Photo-Vivid For viewing photographs. Enhances picture contrast and sharpness.</p> <p>Photo-Standard For viewing photographs. Provides the optimum picture quality for viewing in the home.</p> <p>Photo-Original For viewing photographs. Represents the picture quality used when imaging developed photographs.</p> <p>Photo-Custom For viewing photographs. Allows you to store your preferred settings.</p> <p>Sports Provides the optimum picture quality for viewing sports.</p> <p>Game Most suitable for when playing games on your TV.</p> <p>Graphics Provides the optimum picture quality for viewing graphics.</p> |
| Reset | Resets all the “Picture” settings to the factory settings excluding “Target Inputs”, “Picture Mode” and “Advanced Settings”. |
| Backlight | Adjusts the brightness of the backlight. |
| Contrast | Increases or decreases picture contrast. |
| Brightness | Brightens or darkens the picture. |
| Colour | Increases or decreases colour intensity. |
| Hue | <p>Increases or decreases the green tones and red tones.</p> <p></p> <ul style="list-style-type: none"> “Hue” can be adjusted only for the NTSC colour signal (e.g. U.S.A. video tapes). |

| | |
|--|--|
| Colour Temperature | Adjusts the whiteness of the picture. |
| Cool | Gives white colours a blue tint. |
| Neutral | Gives white colours a neutral tint. |
| Warm 1/Warm 2 | Gives white colours a red tint. “Warm 2” gives a redder tint than “Warm 1”. |
| |  <ul style="list-style-type: none"> • “Warm 1” and “Warm 2” are not available when “Picture Mode” is set to “Vivid” (or “Photo-Vivid”). |
| Sharpness | Sharpens or softens the picture. |
| Noise Reduction | Reduces the noise level of pictures (snowy pictures). |
| MPEG Noise Reduction | Reduces picture noise in MPEG-compressed videos. This is effective when viewing a DVD or digital broadcast. |
| Motionflow (except for KDL-52V55/56xx, 46V55/56xx, 40V55/56xx, 37V55/56xx, 32V55/56xx) | Provides smoother picture movement and reduces picture blur. |
| High | Provides smoother picture movement such as for film-based contents. |
| Standard | Provides smooth picture movement. Use this setting for standard use. |
| Off | Use this setting when the “High” or “Standard” settings result in noise. |
| |  <ul style="list-style-type: none"> • Depending on the video, you may not see the effect visually, even if you have changed the setting. |
| Film Mode | Provides improved picture movement when playing DVD or VCR images taken on film, reducing picture blur and graininess. |
| Auto 1 | Provides smoother picture movement than the original film-based content. Use this setting for standard use. |
| Auto 2 | Provides the original film-based content as is. |
| Off |  <ul style="list-style-type: none"> • If the image contains irregular signals or too much noise, “Film Mode” is automatically turned off even if “Auto 1” or “Auto 2” is selected. |
| Advanced Settings | Allows you to set “Picture” settings in more detail. These settings are not available when “Picture Mode” is set to “Vivid” (or “Photo-Vivid”). |
| Reset | Resets all the advanced settings to the factory settings. |
| Black Corrector | Enhances black areas of the picture for stronger contrast. |
| Adv. Contrast Enhancer | Automatically adjusts “Backlight” and “Contrast” to the most suitable settings judging from the brightness of the screen. This setting is especially effective for dark images scenes, and will increase the contrast distinction of the darker picture scenes. |
| Gamma | Adjusts the balance between bright and dark areas of the picture. |
| Auto Light Limiter | Reduces glare such as in scenes where the entire screen is white. |
| Clear White | Emphasises white colours. |
| Live Colour | Makes colours more vivid. |
| White Balance | Adjusts the temperature of each colour. |



Sound

| | |
|---|---|
| Target Inputs | Allows you to select whether to use the common settings or to make custom settings for the input you are currently viewing. |
| Common | Applies common settings to all inputs in which “Target Inputs” is set to “Common”. |
| Name of current input (e.g. AV1) | Allows you to make custom settings for the input. |
| Sound Mode | Sets a sound mode. “Sound Mode” includes options best suited for video and photographs, respectively. The options that can be selected differ depending on the scene select settings. |
| Dynamic | Enhances the treble and bass sounds. |
| Standard | For standard sounds. Recommended for home entertainment. |
| Clear Voice | Makes voice sound clearer. |
| Reset | Resets all the “Sound” settings to the factory settings excluding “Target Inputs”, “Sound Mode” and “Dual Sound”. |
| Treble | Adjusts higher-pitched sounds. |
| Bass | Adjusts lower-pitched sounds. |
| Balance | Emphasises the left or right speaker. |
| Auto Volume | Keeps volume level constant across all programmes and adverts (e.g. adverts tend to be louder than programmes). |
| Volume Offset | Adjusts the volume level of the current input relative to other inputs, when “Target Inputs” is set to the current input name (e.g. AV1). |
| Surround | Allows you to select the suitable surround effects depending on the genre of TV programme (movie, sport, music, etc.) or video game. The options that can be selected differ depending on the “Scene Select” settings. |
| S-FORCE Front Surround | Delivers surround effects that help you enjoy the virtual multi-ch surround audio with just the two internal TV speakers. |
| Cinema | Delivers surround effects just like the high-grade audio systems found in movie theatres. |
| Music | Delivers surround effects that make you feel like you are surrounded by sound as in a music hall. |
| Sports | Delivers surround effects that make you feel like you are watching a live sports contest. |
| Game | Delivers surround effects that enhance game sound. |
| Off | Converts and reproduces multi-ch audio to 2ch audio. In the case of other audio formats, the original audio is reproduced. |
| Voice Zoom | Adjusts the sound level of human voices. For example, if the voice of a news announcer is indistinct, you can turn up this setting to make the voice louder. Conversely, if you are watching a sports programme, you can turn down this setting to soften the voice of the commentator. |
| Sound Enhancer | Enhances high-frequency sounds. |
| Sound Booster | Produces a fuller sound for more impact, by emphasizing the treble and bass sounds. |

| | |
|--------------------|---|
| Dual Sound | Sets the sound from the speaker for a stereo or bilingual broadcast. |
| Stereo/Mono | For stereo broadcasts. |
| A/B/Mono | For bilingual broadcasts, select “A” for sound channel 1, “B” for sound channel 2, or “Mono” for mono channel, if available. |
| |  <ul style="list-style-type: none"> For other equipment connected to the TV, set “Dual Sound” to “Stereo”, “A”, or “B”. |



Screen (for inputs other than a PC)

| | |
|---|--|
| Target Inputs | Allows you to select whether to use the common settings or to make custom settings for the input you are currently viewing. |
| Common | Applies common settings to all inputs in which “Target Inputs” is set to “Common”. |
| Name of current input (e.g. AV1) | Allows you to make custom settings for the input. |
| Screen Format | See “To change the Screen Format manually” (page 16). |
| Auto Format | Automatically changes “Screen Format” to match the broadcast signal. If you want to use the setting that you specified in “Screen Format”, select “Off”. |
| 4:3 Default | Sets the default screen format for 4:3 broadcasts. |
| Smart | Displays conventional 4:3 broadcasts with an imitation wide screen effect. |
| 4:3 | Displays conventional 4:3 broadcasts in the correct proportion. |
| Off | Uses the setting that you specified in “Screen Format”. |
| Display Area | Adjusts the picture display area. |
| Auto | Automatically switches to the most appropriate display area. |
| Full Pixel | Displays pictures in their original size when parts of the picture are cut off. |
| +1 | Displays pictures in their original size. |
| Normal | Displays pictures in their recommended size. |
| -1/-2 | Enlarges the picture so that the edges are outside the visible display area. |
| Horizontal Shift | Adjusts the horizontal position of the picture. |
| Vertical Shift | Adjusts the vertical position of the picture when “Screen Format” is set to “Smart”, “Zoom” or “14:9”. |
| Vertical Size | Adjusts the vertical size of the picture when “Screen Format” is set to “Smart”. |



Screen (for PC input)

| | |
|-------------------------|--|
| Auto Adjustment | Automatically adjusts the display position, phase, and pitch of the picture when the TV receives an input signal from the connected PC. 💡 • “Auto Adjustment” may not work well with certain input signals. In such cases, manually adjust “Phase”, “Pitch”, “Horizontal Shift”, and “Vertical Shift”. |
| Reset | Resets all PC screen settings to factory settings. |
| Phase | Adjusts the phase when the screen flickers. |
| Pitch | Adjusts the pitch when the picture has unwanted vertical stripes. |
| Horizontal Shift | Adjusts the horizontal position of the picture. |
| Vertical Shift | Adjusts the vertical position of the picture. |
| Screen Format | Sets “Screen Format” for displaying pictures from your PC. |
| | Normal Displays the picture in its original size. |
| | Full 1 Enlarges the picture to fill the vertical display area, while maintaining its original proportion. |
| | Full 2 Enlarges the picture to fill the display area. |



Video Settings

| | |
|----------------------|---|
| Colour System | Sets the colour system (“Auto”, “PAL”, “SECAM”, “NTSC3.58”, or “NTSC4.43”) according to the input signal from the input source. |
|----------------------|---|

















Audio Settings

| | | |
|---------------------------|--|--|
| Speaker | TV Speaker | Turns on and outputs the TV’s sound from the TV speakers. |
| | Audio System | Turns off the TV speakers and outputs the TV’s sound from external audio equipment connected to the audio output sockets/jacks on the TV. |
| Audio Out | Variable | When using an external audio system, volume output from audio out can be controlled using the TV’s remote. |
| | Fixed | The audio output of the TV is fixed. Use your audio receiver’s volume control to adjust the volume (and other audio settings) through your audio system. |
| Headphone Settings | Speaker Link | Switches the TV’s internal speakers on/off when you connect headphones to the TV. |
| | Volume | Adjusts the volume of the headphones when “ Speaker Link” is set to “Off”. |
| | Dual Sound | Sets the sound from the headphones for a bilingual broadcast. |
| Optical Out | Sets the audio signal that is output from the DIGITAL AUDIO OUT (OPTICAL) jack of the TV. Set to “Auto”, when connecting equipment compatible with Dolby Digital. Set to “PCM”, when connecting equipment not compatible with Dolby Digital. | |



Set-up

| | |
|-----------------------|---|
| USB Auto Start | Automatically starts photo playback when the TV is turned on and a digital still camera or other device storing photo files is connected to the USB port then turned on. |
| |  <ul style="list-style-type: none"> Playback does not start automatically if the TV is turned on after connecting the digital still camera or other device to the USB port. |
| Quick Start | The TV turns on faster than usual by turning on the power using the remote. However, power consumption in standby mode is approximately 20 watts higher than usual. Up to 3 out of 5 time zones can be set. |
| AV Preset | Assigns an icon or name to equipment connected to the side and rear sockets/jacks. The icon and name appear briefly on the screen when you select the equipment. |
| | <p>1 Press  to select the desired input source, then press .</p> |
| | <p>Skip AV Inputs For each input, sets whether or not to display on the Home Menu or in a list of inputs that will appear when you press .</p> <p>Auto Displays the icon and name only when the equipment is connected (except for AV1 or AV2 inputs).</p> <p>Always Display Always displays the icon and name regardless of whether or not the equipment is connected.</p> <p>Skip Does not display the icon and name even if the equipment is connected.</p> |
| | <p>2 Press  to assign an icon and name.</p> |
| | <p>Label AV Inputs Uses preset labels to assign a name to connected equipment. Allows you to create your own label when you select “Edit”.</p> <p>Edit Allows you to edit the name in the edit screen and choose the appropriate icon.</p> |
| AV2 Input | Sets a signal to be input through the socket labelled  AV2 on the rear of the TV. |
| | <p>Auto Switches automatically among the signals of RGB input, S video input, Composite video input depending on the input signal.</p> |
| | <p>RGB Inputs the RGB signal.</p> |
| | <p>S Video Inputs the S Video signal.</p> |
| | <p>Composite Inputs the Composite video signal.</p> |
| AV2 Output | Sets a signal to be output to the  AV2 socket. If you connect a VCR or other recording equipment to the  AV2 socket, you can record the output signal from other equipment connected to the TV. |
| | <p>TV Outputs TV broadcasts.</p> |
| | <p>AV1 Outputs signals from equipment connected to the  AV1 socket.</p> |
| | <p>AV3 Outputs signals from equipment connected to the  AV3 socket.</p> |
| | <p>Auto Outputs whatever is being viewed on the screen (except signals from the  COMPONENT IN, HDMI IN1, 2, 3, or 4, and PC IN  sockets).</p> |

| | |
|----------------------------|--|
| HDMI Set-up | Allows the TV to communicate with equipment that is compatible with the Control for HDMI function, and connected to the HDMI sockets/jacks of the TV. Note that communication settings must also be made on the connected equipment. |
| Control for HDMI | Sets whether or not to link the operations of the TV and the connected equipment that is compatible with Control for HDMI. When set to “On”, the following functions are available. If the specific Sony equipment that is compatible with Control for HDMI is connected, this setting is applied to the connected equipment automatically when the “Control for HDMI” is set to “On” using the TV. |
| Auto Devices Off | When this is set to “On”, the connected equipment that is compatible with Control for HDMI turns off when you turn off the TV. |
| Auto TV On | When this is set to “On”, the TV turns on when you turn on the connected equipment that is compatible with Control for HDMI. |
| Tuner Box Control | If set to “Advanced”, you can select a channel tuned by connected equipment using the TV’s remote. |
| HDMI Device List | Displays a list of connected equipment that is compatible with Control for HDMI. |
| |  <ul style="list-style-type: none"> You cannot use “Control for HDMI” if the TV operations are linked to the operations of an audio system that is compatible with Control for HDMI. |
| Auto Start-up | You can run the initial Set-up that appeared when you first connected the TV, and select the language and country/area, or tune in all available channels again. Even if you have made the settings when you first connected the TV, you may need to change the settings after moving house, or to search for newly launched channels. |
| Language | Sets the language displayed on the menu screens. |
| Product Information | Displays product information of the TV. |
| Factory Settings | Resets all settings to factory settings and displays the initial Set-up screen. |
| |  <ul style="list-style-type: none"> Settings for the Favourite lists, country/area, and language will also be reset to factory settings. |



Analogue Set-up

| | |
|-------------------------------|--|
| Programme List Display | Select “Off” to hide the list of analogue channels from the XMB™ (XrossMediaBar). |
| 1 Digit Direct | When “1 Digit Direct” is set to “On”, you can select an analogue channel using one preset number button (0 – 9) on the remote.  <ul style="list-style-type: none"> When “1 Digit Direct” is set to “On”, you cannot select channel numbers 10 and above by entering two digits on the remote. |
| Favourite Set-up | Adds channels in a Favourite list. |
| Auto Tuning | Tunes in all the available analogue channels. You can retune the TV after moving house, or to search for newly launched channels. |

| | |
|--------------------------------|---|
| Programme Sorting | <p>Changes the order of analogue channels stored in the TV.</p> <ol style="list-style-type: none"> 1 Press \leftarrow/\rightarrow to select the channel you want to move to a new position, then press \oplus. 2 Press \leftarrow/\rightarrow to select the new position for the channel, then press \oplus. |
| Programme Labels | <p>Assigns a channel name of your choice, up to five letters or numbers. The name appears briefly on the screen when you select the channel. (Names for channels are usually taken automatically from Text (if available).)</p> <ol style="list-style-type: none"> 1 Press \leftarrow/\rightarrow to select the channel you want to name, then press \oplus. 2 Press \leftarrow/\rightarrow to select the desired letter or number (“_” for a blank space), then press \rightarrow. <p>If you enter a wrong character</p> <p>Press \leftarrow/\rightarrow to select the wrong character. Then, press \leftarrow/\rightarrow to select the correct character.</p> <ol style="list-style-type: none"> 3 Repeat step 2 until you finish entering the name. 4 Press \oplus to exit the labeling procedure. |
| Intelligent Picture | <p>On with Indicator Automatically reduces the picture noise. The signal level bar is displayed when the channel is changed or the display is changed from an input screen to a TV programme.</p> <hr/> <p>On Automatically reduces the picture noise.</p> <hr/> <p>Off Turns off the “Intelligent Picture” feature.</p> |
| Manual Programme Preset | <p>To preset a channel, press PROG +/- to select the programme number, before selecting “Label”, “AFT”, “Audio Filter”, “Skip”, “Decoder”, or “LNA”. You cannot select a programme number that is set to “Skip” (page 42).</p> <hr/> <p>Programme/System/Channel Allows you to preset programme channels manually.</p> <ol style="list-style-type: none"> 1 Press \leftarrow/\rightarrow to select “Programme”, then press \oplus. 2 Press \leftarrow/\rightarrow to select the programme number you want to manually tune (if tuning a VCR, select channel 00), then press \oplus. 3 Press \leftarrow/\rightarrow to select “System”, then press \oplus. 4 Press \leftarrow/\rightarrow to select one of the following TV broadcast systems, then press \oplus. <ul style="list-style-type: none"> B/G: For western European countries/areas I: For the United Kingdom D/K: For eastern European countries/areas L: For France 5 Press \leftarrow/\rightarrow to select “Channel”, then press \oplus. 6 Press \leftarrow/\rightarrow to select “S” (for cable channels) or “C” (for terrestrial channels), then press \rightarrow. 7 Tune the channels as follows: <p>If you do not know the channel number (Frequency)</p> <p>Press \leftarrow/\rightarrow to search for the next available channel. The search stops when a channel is found. To continue searching, press \leftarrow/\rightarrow.</p> <p>If you know the channel number (Frequency)</p> <p>Press the number buttons to enter the channel number of the broadcast you want to tune, or the channel number of your VCR.</p> 8 Press \oplus to jump to “Confirm”, then press \oplus. Repeat the above procedure to preset other channels manually. |

| | |
|---------------------|--|
| Label | Assigns a name of your choice to the selected channel. This name appears briefly on the screen when you select the channel. To input characters, follow steps 2 to 4 in “Programme Labels” (page 41). |
| AFT | Allows you to fine-tune the selected channel manually if you feel that a slight tuning adjustment may improve picture quality. When “On” is selected, fine tuning adjustments are made automatically. |
| Audio Filter | Improves the sound of individual channels when distortion occurs in mono broadcasts (normally set to “Off”).  • You cannot receive stereo or dual sound when “Low” or “High” is selected. |
| Skip | Skips unused analogue channels when you press PROG +/- to select channels. To select channels you have programmed to skip, use the corresponding number buttons. |
| LNA | Improves the picture quality of the channel (noisy picture) when the broadcast signal is very weak. |
| Confirm | Saves changes you have made to the “Manual Programme Preset” settings. |



Digital Set-up

| | | |
|------------------------|----------------------------|---|
| Subtitle Set-up | Subtitle Setting | When set to “For Hard Of Hearing”, visual aids for the hearing impaired are displayed with the subtitles (when such visual aids are available). |
| | Preferred Language | Allows you to select the language of the subtitles. |
| Audio Set-up | Audio Type | Switches to broadcast for the hearing impaired when you select “For Hard Of Hearing”. |
| | Preferred Language | Sets the language to be used for a programme. Some digital channels may broadcast several audio languages for a programme. |
| | Audio Description | Provides audio description (narration) of visual information, when such information is available. |
| | Mixing Level | Adjusts the TV main audio and “Audio Description” output levels. |
| | Dynamic Range | Compensates for differences in the audio level between different channels (only for Dolby Digital audio).  • The effect may not function or may vary depending on the programme regardless of the “Dynamic Range” setting. |
| | MPEG Audio Level | Adjusts the MPEG audio sound level. |
| Digital Tuning | Digital Auto Tuning | Tunes in the available digital channels. You can retune the TV after moving house, or to search for newly launched channels. |

| | |
|------------------------------|---|
| Programme Sorting | <p>Allows you to remove or change the order of digital channels stored in the TV.</p> <ol style="list-style-type: none"> 1 Press \leftarrow/\rightarrow to select the channel you want to remove or move to a new position. 2 Remove or change the order of the digital channels as follows: <ul style="list-style-type: none"> To remove a digital channel Press \oplus. After a confirmation message appears, press \leftarrow to select “Yes”, then press \oplus. To change the order of the digital channels Press \rightleftarrows, then press \leftarrow/\rightarrow to select the new position for the channel and press \leftarrow. 3 Press \rightarrow RETURN. |
| Digital Manual Tuning | <p>Tunes the digital channels manually. This feature is available when “Digital Auto Tuning” is set to “Antenna”.</p> <ol style="list-style-type: none"> 1 Press the number buttons to enter the channel number you want to tune, or press \leftarrow/\rightarrow. 2 When the available channels are found, press \leftarrow/\rightarrow to select the channel you want to store, then press \oplus. 3 Press \leftarrow/\rightarrow to select the channel number where you want to store the new channel, then press \oplus. <p>Repeat the above procedure to tune other channels.</p> |
| LNA | Improves the picture quality of the channel (noisy picture) when the broadcast signal is very weak. |
| Radio Display | Displays the screen wallpaper when you listen to a radio broadcast. You can select the screen wallpaper colour, display a random colour or view a slideshow (page 25, 30). To cancel the screen wallpaper display temporarily, press any button. |
| Parental Lock | Sets an age restriction to viewing. To view any programme rated for ages above the age you specify, enter the correct PIN code. |
| PIN Code | <p>Enter your PIN code to activate “Parental Lock”. You can also change the PIN code.</p>  <ul style="list-style-type: none"> • PIN code 9999 is always accepted. |
| Technical Set-up | <p>Auto Service Update Enables the TV to detect and store new digital services as they become available.</p> <p>System Update Enables the TV to automatically receive free software updates through your existing aerial/antenna/cable (when issued). We recommend that you leave the setting to “On” at all times.</p> <p>System Information Displays the current software version and the signal level.</p> <p>Time Zone Allows you to manually select the time zone you are in, if it is not the same as the default time zone setting for your country/area.</p> <p>Auto DST Select “On” to automatically switch between summer time and winter time according to the calendar.</p> <p>Service Replacement Select “On” to automatically change the channel when broadcaster changes transmission of the viewing programme to a different channel.</p> <p>Programme Guide (only when GUIDE Plus+ is available) You can switch GUIDE (Sony Guide or GUIDE Plus+). If you change Sony Guide to GUIDE Plus+ programme (page 17).</p> |

| | |
|-------------------------|--|
| CA Module Set-up | Provides access to a pay TV service after you obtain a Conditional Access Module (CAM) and a view card. See the location of the  (PCMCIA) socket (page 22). |
|-------------------------|--|



Network Settings

| | | |
|--------------------------------|---|--|
| Network | IP Address Settings | <p>Manual Allows you to set the network settings according to your network environment.</p> <hr/> <p>DHCP (DNS manual) Automatically acquires the network settings except for DNS server settings. You can manually set the DNS settings.</p> <hr/> <p>DHCP (DNS automatic) Automatically acquires the network settings through the Dynamic Host Configuration Protocol server function of the router or Internet service provider.</p> <hr/> <p>Test Diagnoses whether the network is correctly connected.</p> <hr/> <p>IP Address/ Subnet Mask/ Default Gateway/ Primary DNS/ Secondary DNS You need to configure each item when “Manual” is selected in “IP Address Settings”. When “DHCP (DNS manual)” is selected, be sure to enter “Primary DNS” and “Secondary DNS” server addresses manually.</p> <hr/> <p>MAC Address Displays the “MAC address”, which is a fixed, globally unique identifier of the network device.</p> |
| Server Display Settings | Displays the connected server list and allows you to select the server you want to display on the Home Menu. | |
| Server Diagnostics | Diagnoses whether the TV can connect to each server on the home network. | |
| Renderer Function | Enables playback of photo/music/video files on the TV through other control devices on the network, such as a digital still camera or mobile phone. | |
| Renderer Access Control | Allows you to specify the accessible controller to the TV. When this setting is set to “On”, you can playback Photo/Music/Video files on the TV using the controller. | |
| Renderer Set-up | Automatic Access Permission | Allows you to select whether to permit access to the TV automatically when a network device accesses the TV for the first time. |
| | Renderer Name | Allows you to set the name of the TV to be shown on the controller. |

Installing the Accessories (Wall-Mount Bracket)

To Customers:

For product protection and safety reasons, Sony strongly recommends that installing of your TV be performed by Sony dealers or licensed contractors. Do not attempt to install it yourself.

To Sony Dealers and Contractors:

Provide full attention to safety during the installation, periodic maintenance and examination of this product.

Your TV can be installed using the SU-WL500 Wall-Mount Bracket (sold separately).

- Refer to the Instructions supplied with the Wall-Mount Bracket to properly carry out the installation.
- Refer to “Detaching the Table-Top Stand from the TV” (page 7).
- Refer to “TV installation dimensions table” (page 46).
- Refer to “Screw and Hook locations diagram/table” (page 47).



- Place the TV on the Table-Top Stand, when securing the Mounting Hook.

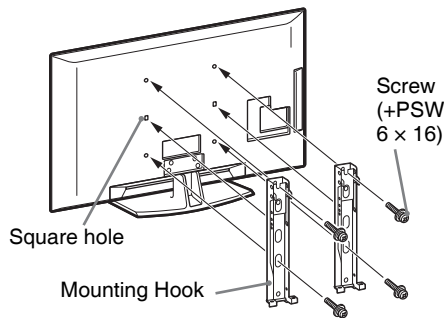

Sufficient expertise is required for installing this product, especially to determine the strength of the wall for withstanding the TV's weight. Be sure to entrust the attachment of this product to the wall to Sony dealers or licensed contractors and pay adequate attention to safety during the installation. Sony is not liable for any damage or injury caused by mishandling or improper installation.

TV installation dimensions table

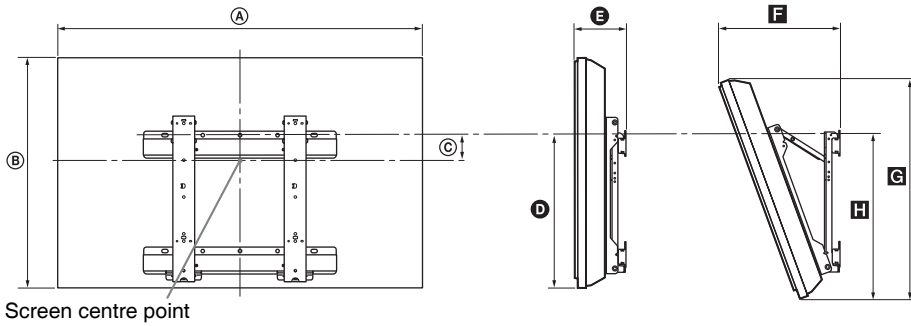

Unit: cm

| Model Name | Display dimensions | | Screen centre dimension | Length for each mounting angle | | | | |
|-----------------------|--------------------|------|-------------------------|--------------------------------|------|-------------|------|------|
| | | | | Angle (0°) | | Angle (20°) | | |
| | A | B | | D | E | F | G | H |
| KDL-52V55/56xx | 126.2 | 82.2 | 3.9 | 47.8 | 16.9 | 40.7 | 77.8 | 51.5 |
| KDL-46V55/56xx | 112.3 | 72.3 | 8.4 | 47.1 | 15.0 | 35.8 | 68.5 | 50.2 |
| KDL-46W55/57xx | 112.3 | 72.5 | 8.4 | 47.1 | 15.0 | 35.9 | 68.6 | 50.3 |
| KDL-46WE5xx | 112.3 | 72.5 | 8.4 | 47.1 | 16.7 | 37.6 | 68.6 | 50.9 |
| KDL-40V55/56xx | 98.7 | 63.6 | 12.2 | 46.3 | 14.7 | 32.8 | 60.4 | 49.3 |
| KDL-40W55/57xx | 98.7 | 63.8 | 12.2 | 46.3 | 14.7 | 33.0 | 60.4 | 49.3 |
| KDL-40WE5xx | 98.7 | 63.8 | 12.2 | 46.3 | 16.4 | 34.7 | 60.4 | 49.9 |
| KDL-40E55xx | 101.6 | 64.3 | 12.2 | 45.1 | 14.8 | 33.8 | 61.1 | 48.5 |
| KDL-37V55/56xx | 91.7 | 60.0 | 14.0 | 46.3 | 14.5 | 31.4 | 57.0 | 49.3 |
| KDL-37W55/57xx | 91.7 | 60.2 | 14.0 | 46.3 | 14.5 | 31.6 | 57.0 | 49.3 |
| KDL-32V55/56xx | 79.8 | 53.6 | 17.2 | 46.3 | 14.3 | 29.1 | 51.1 | 49.2 |
| KDL-32W55/57xx | 79.8 | 53.7 | 17.2 | 46.3 | 14.3 | 29.2 | 51.1 | 49.2 |
| KDL-32E55xx | 82.7 | 53.9 | 17.2 | 45.1 | 14.5 | 29.9 | 51.3 | 48.3 |

Figures in the above table may differ slightly depending on the installation.

WARNING

The wall that the TV will be installed on should be capable of supporting a weight of at least four times that of the TV. Refer to “Specifications” (page 48) for its weight.

Screw and Hook locations diagram/table

| Model Name | Screw location | Hook location |
|----------------|----------------|---------------|
| KDL-52V55/56xx | d, g | b |
| KDL-46V55/56xx | d, g | b |
| KDL-46W55/57xx | d, g | b |
| KDL-46WE5xx | d, g | b |
| KDL-40V55/56xx | d, g | b |
| KDL-40W55/57xx | d, g | b |
| KDL-40WE5xx | d, g | b |
| KDL-40E55xx | d, g | b |
| KDL-37V55/56xx | d, g | b |
| KDL-37W55/57xx | d, g | b |
| KDL-32V55/56xx | e, g | c |
| KDL-32W55/57xx | e, g | c |
| KDL-32E55xx | e, g | c |

Screw location

When installing the Mounting Hook on the TV.

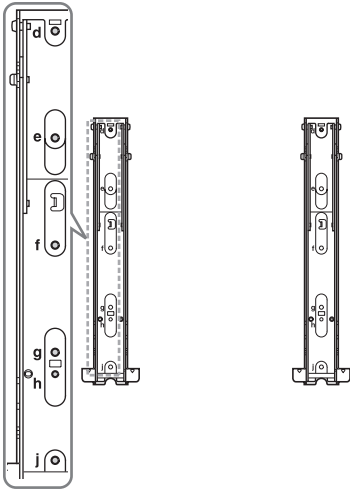





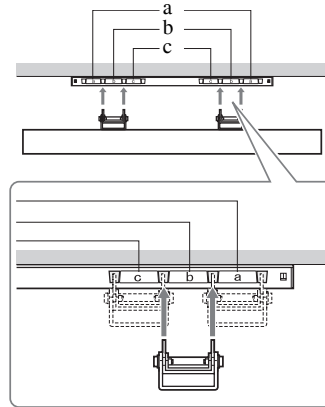



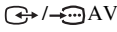



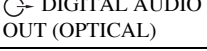

Hook location

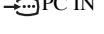
When installing the TV onto the Base Bracket.



Specifications

| System | |
|---|---|
| Panel system | LCD (Liquid Crystal Display) Panel |
| TV system | Analogue: Depending on your country/area selection: B/G/H, D/K, L, I Digital: DVB-T/DVB-C |
| Colour/video system | Analogue: PAL, PAL60 (only video input), SECAM, NTSC3.58, NTSC4.43 (only video input) Digital: MPEG-2 MP@ML/HL, H.264/MPEG-4 AVC MP/HP@L4 |
| Channel coverage | Analogue: VHF: E2–E12/UHF: E21–E69/CATV: S1–S20/HYPER: S21–S41 D/K: R1–R12, R21–R69/L: F2–F10, B–Q, F21–F69/I: UHF B21–B69 Digital: VHF/UHF |
| Sound output | 10 W + 10 W |
| Input/Output jacks | |
| Aerial/Antenna cable | 75 ohm external terminal for VHF/UHF |
|  AV1 | 21-pin scart connector (CENELEC standard) including audio/video input, RGB input and TV audio/video output. |
|  AV2 | 21-pin scart connector (CENELEC standard) including audio/video input, RGB input and selectable audio/video output. |
|  COMPONENT IN | Supported formats: 1080p, 1080i, 720p, 576p, 576i, 480p, 480i Y: 1 Vp-p, 75 ohms, 0.3V negative sync/Pb/Cb: 0.7 Vp-p, 75 ohms/ Pr/Cr: 0.7 Vp-p, 75 ohms |
|  COMPONENT IN | Audio input (phono jacks) |
| HDMI IN1, 2, 3, 4 | Video: 1080/24p, 1080p, 1080i, 720p, 576p, 576i, 480p, 480i Audio: Two channel linear PCM: 32, 44.1 and 48 kHz, 16, 20 and 24 bits, Dolby Digital Analogue audio input (minijack) (HDMI IN1 only) PC Input (page 50) |
|  AV3 | Video input (phono jack) |
|  AV3 | Audio input (phono jacks) |
|  DIGITAL AUDIO OUT (OPTICAL) | Digital optical jack (Two channel linear PCM, Dolby Digital) |
|  | Audio output (phono jacks) |
|  PC IN | PC Input (D-sub 15-pin) (page 50) G: 0.7 Vp-p, 75 ohms, non Sync on Green/B: 0.7 Vp-p, 75 ohms/ R: 0.7 Vp-p, 75 ohms/HD: 1-5 Vp-p/VD: 1-5 Vp-p  PC audio input (minijack) |
|  | USB port |
|  | Headphones jack |
|  | CAM (Conditional Access Module) slot |
|  LAN | 10BASE-T/100BASE-TX connector (Depending on the operating environment of the network, connection speed may differ. 10BASE-T/100BASE-TX communication rate and communication quality are not guaranteed for this TV.) |

| Model name | | KDL-52V55/56xx | KDL-46V55/56xx, 46W55/57xx, 46WE5xx | KDL-40V55/56xx, 40W55/57xx, 40WE5xx, 40E55xx | KDL-37V55/56xx, 37W55/57xx | KDL-32V55/56xx, 32W55/57xx, 32E55xx |
|-----------------------------------|----------------------------|--|---|--|--|--|
| Power and others | | | | | | |
| Power requirements | | 220 V – 240 V AC, 50 Hz | | | | |
| Screen size (measured diagonally) | | 52 inches (Approx. 132.2 cm) | 46 inches (Approx. 116.8 cm) | 40 inches (Approx. 101.6 cm) | 37 inches (Approx. 93.98 cm) | 32 inches (Approx. 81.28 cm) |
| Display resolution | | 1,920 dots (horizontal) × 1,080 lines (vertical) | | | | |
| Power consumption | in “Home”/ “Standard” mode | 195 W | 162 W (KDL-46V55/56xx) 172 W (KDL-46W55/57xx) 116 W (KDL-46WE5xx) | 137 W (KDL-40V55/56xx) 131 W (KDL-40W55/57xx, 40E55xx) 102 W (KDL-40WE5xx) | 132 W (KDL-37V55/56xx) 140 W (KDL-37W55/57xx) | 89 W (KDL-32V55/56xx) 81 W (KDL-32W55/57xx, 32E55xx) |
| | in “Shop”/ “Vivid” mode | 257 W | 206 W (KDL-46V55/56xx) 221 W (KDL-46W55/57xx) 144 W (KDL-46WE5xx) | 179 W (KDL-40V55/56xx) 172 W (KDL-40W55/57xx, 40E55xx) 122 W (KDL-40WE5xx) | 169 W (KDL-37V55/56xx) 179 W (KDL-37W55/57xx) | 109 W (KDL-32V55/56xx) 99 W (KDL-32W55/57xx, 32E55xx) |
| Standby power consumption* | | 0.17 W (17 W when “Quick Start” is set to “On”) | | | | |
| Supplied accessories | | See “To check the accessories” (page 4). | | | | |
| Optional accessories | Wall-Mount Bracket | SU-WL500 | | | | |

| Model name | | KDL-52V55/56xx | KDL-46V55/56xx, 46W55/57xx, 46WE5xx | KDL-40V55/56xx, 40W55/57xx, 40WE5xx, 40E55xx | KDL-37V55/56xx, 37W55/57xx | KDL-32V55/56xx, 32W55/57xx, 32E55xx |
|----------------------------------|------------------------|--|--|--|---|-------------------------------------|
| Dimensions (Approx.) (w × h × d) | | | | | | |
| with Table-Top Stand | 126.2 x 86.9 x 35.8 cm | 112.3 x 77.1 x 33.0 cm (KDL-46V55/56xx) 112.3 x 77.2 x 33.0 cm (KDL-46W55/57xx, 46WE5xx) | 98.7 x 68.4 x 30.3 cm (KDL-40V55/56xx) 98.7 x 68.6 x 30.3 cm (KDL-40W55/57xx, 40WE5xx) 101.6 x 68.0/66.3 (high/low) x 30.3 cm (KDL-40E55xx) | 91.7 x 64.8 x 30.3 cm (KDL-37V55/56xx) 91.7 x 64.9 x 30.3 cm (KDL-37W55/57xx) | 79.8 x 58.4 x 25.9 cm (KDL-32V55/56xx) 79.8 x 58.5 x 25.9 cm (KDL-32W55/57xx) 82.7 x 57.7/55.9 (high/low) x 25.9 cm (KDL-32E55xx) | |
| without Table-Top Stand | 126.2 x 82.2 x 11.5 cm | 112.3 x 72.3 x 9.6 cm (KDL-46V55/56xx) 112.3 x 72.5 x 9.6 cm (KDL-46W55/57xx) 112.3 x 72.5 x 10.7 cm (KDL-46WE5xx) | 98.7 x 63.6 x 9.3 cm (KDL-40V55/56xx) 98.7 x 63.8 x 9.3 cm (KDL-40W55/57xx) 98.7 x 63.8 x 10.4 cm (KDL-40WE5xx) 101.6 x 64.3 x 9.8 cm (KDL-40E55xx) | 91.7 x 60.0 x 9.1 cm (KDL-37V55/56xx) 91.7 x 60.2 x 9.1 cm (KDL-37W55/57xx) | 79.8 x 53.6 x 8.9 cm (KDL-32V55/56xx) 79.8 x 53.7 x 8.9 cm (KDL-32W55/57xx) 82.7 x 53.9 x 9.4 cm (KDL-32E55xx) | |
| Mass (Approx.) | | | | | | |
| with Table-Top Stand | 35.0 kg | 27.0 kg (KDL-46V55/56xx) 27.5 kg (KDL-46W55/57xx, 46WE5xx) | 20.5 kg (KDL-40V55/56xx, 40E55xx) 21.0 kg (KDL-40W55/57xx, 40WE5xx) | 18.0 kg (KDL-37V55/56xx) 18.5 kg (KDL-37W55/57xx) | 14.5 kg (KDL-32V55/56xx, 32E55xx) 15.0 kg (KDL-32W55/57xx) | |
| without Table-Top Stand | 30.5 kg | 23.5 kg (KDL-46V55/56xx) 24.0 kg (KDL-46W55/57xx, 46WE5xx) | 17.5 kg (KDL-40V55/56xx) 18.0 kg (KDL-40W55/57xx, 40WE5xx, 40E55xx) | 15.0 kg (KDL-37V55/56xx) 15.5 kg (KDL-37W55/57xx) | 12.0 kg (KDL-32V55/56xx) 12.5 kg (KDL-32W55/57xx, 32E55xx) | |

*Specified standby power is reached after the TV finishes necessary internal processes.
Design and specifications are subject to change without notice.

PC input signal reference chart for PC and HDMI IN 1, 2, 3, 4

| <i>Resolution</i> | | | <i>Horizontal frequency (kHz)</i> | <i>Vertical frequency (Hz)</i> | <i>Standard</i> | |
|-------------------|---------------------------|--------------------------|-----------------------------------|--------------------------------|-----------------|-----------------|
| <i>Signals</i> | <i>Horizontal (Pixel)</i> | <i>× Vertical (Line)</i> | | | | |
| VGA | 640 | × | 480 | 31.5 | 60 | VGA |
| | 640 | × | 480 | 37.5 | 75 | VESA |
| | 720 | × | 400 | 31.5 | 70 | VGA-T |
| SVGA | 800 | × | 600 | 37.9 | 60 | VESA Guidelines |
| | 800 | × | 600 | 46.9 | 75 | VESA |
| XGA | 1024 | × | 768 | 48.4 | 60 | VESA Guidelines |
| | 1024 | × | 768 | 56.5 | 70 | VESA |
| | 1024 | × | 768 | 60.0 | 75 | VESA |
| WXGA | 1280 | × | 768 | 47.4 | 60 | VESA |
| | 1280 | × | 768 | 47.8 | 60 | VESA |
| | 1280 | × | 768 | 60.3 | 75 | |
| | 1360 | × | 768 | 47.7 | 60 | VESA |
| SXGA | 1280 | × | 1024 | 64.0 | 60 | VESA |
| HDTV | 1920 | × | 1080 | 67.5 | 60 | CEA-861* |

* 1080p timing when applied to the HDMI input will be treated as a video timing and not a PC timing. This affects the “Video Settings” menu and “Screen” menu settings.

To view PC contents, set “Screen Format” to “Wide” and “Display Area” to “Full Pixel”.





- This TV’s PC input does not support Sync on Green or Composite Sync.
- This TV’s PC input does not support interlaced signals.
- For the best picture quality, it is recommended to use the signals in the above chart with a 60 Hz vertical frequency (boldfaced).

Troubleshooting

Check whether the  (standby) indicator is flashing in red.







When the (standby) indicator is flashing





The self-diagnosis function is activated.

- Count how many times the  (standby) indicator flashes between each two second break.
For example, the indicator may flash three times, go off for two seconds, then flash again three times.
- Press  on the TV to turn it off, disconnect the mains lead, and inform your dealer or Sony service centre of how the indicator flashes (number of flashes).

When the (standby) indicator is not flashing

- Check the items in the tables below.
- If the problem persists, have your TV serviced by qualified service personnel.

| Condition | Explanation/Solution |
|--|---|
| Picture | |
| There is no picture (screen is dark) and no sound. | <ul style="list-style-type: none"> • Check the aerial/antenna/cable connection. • Connect the TV to the mains/AC power, and press  on the TV. • If the  (standby) indicator lights up in red, press . |
| No picture or menu information from equipment connected to the scart connector appears on the screen. | <ul style="list-style-type: none"> • Press  to display the list of inputs, then select the desired input. • Check the connection between the optional equipment and the TV. |
| Ghosting occurs, or double images appear. | <ul style="list-style-type: none"> • Check the aerial/antenna/cable connection. • Check the aerial/antenna location and direction. |
| Only snow and noise appear on the screen. | <ul style="list-style-type: none"> • Check if the aerial/antenna is broken or bent. • Check if the aerial/antenna has reached the end of its serviceable life (three to five years for normal use, one to two years when used at the seaside). |
| There is picture or sound noise when viewing a TV channel. | <ul style="list-style-type: none"> • Adjust “AFT” (Automatic Fine Tuning) to obtain better picture reception (page 42). |
| Tiny black points and/or bright points appear on the screen. | <ul style="list-style-type: none"> • The screen is composed of pixels. Tiny black points and/or bright points (pixels) on the screen do not indicate a malfunction. |
| The picture contours are distorted. | <ul style="list-style-type: none"> • Select “Standard” or “Off” in “Motionflow” (page 35) (except for KDL-52V55/56xx, 46V55/56xx, 40V55/56xx, 37V55/56xx, 32V55/56xx). • Change the current setting of “Film Mode” to other settings (page 35). |
| The picture is not displayed in colour. | <ul style="list-style-type: none"> • Select “Reset” (page 34). |
| The picture from equipment connected to the  COMPONENT IN sockets is not displayed in colour, or is displayed in irregular colours. | <ul style="list-style-type: none"> • Check the connection of the  COMPONENT IN sockets and check if the sockets are firmly seated in their respective sockets. |

| Condition | Explanation/Solution |
|--|--|
| No picture from the connected equipment appears on the screen. | <ul style="list-style-type: none"> • Turn the connected equipment on. • Check the cable connection. • Press  to display the list of inputs, then select the desired input. • Correctly insert the memory card or other storage device in the digital still camera. • Use a digital still camera memory card or other storage device that has been formatted according to the instruction manual supplied with the digital still camera. • Operations are not guaranteed for all USB devices. Also, operations differ depending on the features of the USB device and the video being played. |
| You cannot select the connected equipment on the Home Menu or you cannot switch the input. | <ul style="list-style-type: none"> • Check the cable connection. • Set the server to be displayed on the Home Menu (page 31). |
| Sound | |
| The picture is good, but there is no sound. | <ul style="list-style-type: none"> • Press  +/- or  (Mute). • Check if the “Speaker” is set to “TV Speaker” (page 38). • When using HDMI input with Super Audio CD or DVD-Audio, DIGITAL AUDIO OUT (OPTICAL) may not output audio signals. |
| Channels | |
| You cannot select your desired channel. | <ul style="list-style-type: none"> • Switch between digital and analogue mode, and select the desired digital/analogue channel. |
| Some channels are blank. | <ul style="list-style-type: none"> • The channel is for scrambled/subscription service only. Subscribe to a pay TV service. • The channel is used only for data (no picture or sound). • Contact the broadcaster for transmission details. |
| You cannot view digital channels. | <ul style="list-style-type: none"> • Contact a local installer to find out if digital transmissions are provided in your area. • Upgrade to a higher gain aerial/antenna. |
| Home Network | |
| Connection diagnostic results indicate a failure. | <p>Check Connections</p> <ul style="list-style-type: none"> • Use a straight cable for the LAN cable. • Check if the cable is connected firmly. • Check the connection between the TV and the router. <p>Check Settings</p> <ul style="list-style-type: none"> • Change the IP address for the DNS server (“Checking the Network Connection” (page 31)) while referring to the following. <ul style="list-style-type: none"> –Contact your Internet service provider. –Specify the IP address of the router if you do not know the DNS of your Internet service provider. |
| The server cannot be found, a list cannot be retrieved, and playback fails. | <ul style="list-style-type: none"> • Once server settings are changed, turn the TV off and on by pressing  on the TV. • Execute “Server Diagnostics” (page 31). <p>When using a PC as the server</p> <ul style="list-style-type: none"> • Check if the PC is turned on. Do not turn off the PC while accessing. • If security software is installed on the PC, be sure to allow connections from external devices. For details, refer to the manual supplied with your security software. • The load on the PC may be too high or the server application may become unstable. Try the following: <ul style="list-style-type: none"> –Stop the server application and restart it. –Restart the PC. –Reduce the number of applications running on the PC. –Reduce the amount of content. |

| Condition | Explanation/Solution |
|--|---|
| Changes on the server are not being applied or displayed content differs from content on the server. | <ul style="list-style-type: none"> • Sometimes changes are not applied to displays on the TV even though content has been added and/or deleted on the server. If this happens, go back up one level and try opening the folder or server again. |
| Photo, music and/or video files do not appear or icons are not displayed. | <p>Preliminary Check</p> <ul style="list-style-type: none"> • Check that the connected device supports DLNA. • Operations are not guaranteed for all servers. Also, operations differ depending on the features of the server and the content in question. • Turn the connected device on. <p>Check Connections</p> <ul style="list-style-type: none"> • Check that the LAN cable and/or mains lead/AC power cord of the server has not become disconnected. <p>Check Settings</p> <ul style="list-style-type: none"> • Check that the connected device is registered under “Server Display Settings” (page 31). • Check that the server is correctly configured. • Check that the selected device is connected to the network and can be accessed. • If the “IP Address Settings” in “Network” under “Network Settings” is set to “DHCP (DNS automatic)” or “DHCP (DNS manual)”, it may take some time to recognise devices if there is no DHCP server. Execute “Server Diagnostics” (page 31). |
| The TV cannot be found from renderer-compatible device (the controller). | <p>Check Connections</p> <ul style="list-style-type: none"> • Check that the LAN cable and/or mains lead of the server has not become disconnected. <p>Check Settings</p> <ul style="list-style-type: none"> • Check if the “Renderer Function” is activated (page 44). • Check that the connected device is registered under “Renderer Access Control” (page 44). |
| Only a few icons appear under the “Network” in the Home Menu. | <ul style="list-style-type: none"> • This is normal when internet connection is not available. You can use three pre-installed Widgets properly. To enjoy more Widgets, please check that the LAN cable and/or mains lead/AC power cord of the router/modem has not become disconnected. (*) |
| You have been using registered Widgets, but now some contents won't appear on the Widgets. | <ul style="list-style-type: none"> • Check that the LAN cable and/or mains lead/AC power cord of the router/modem has not become disconnected. (*) • There's a possibility that the Widget Provider's server is out of service. Please try using the Widget later. <p>(*) Your router/modem must be properly set to connect to the internet in advance. Please contact your Internet Service Provider for the router/modem settings.</p> |
| General | |
| The TV's power cannot be turned on. | <ul style="list-style-type: none"> • Check if ENERGY SAVING SWITCH is on (page 10) (KDL-46WE5/40WE5xx only). |
| Distorted picture and/or sound | <ul style="list-style-type: none"> • Keep the TV away from electrical noise sources such as cars, motorcycles, hair-dryers or optical equipment. • When installing optional equipment, leave some space between the optional equipment and the TV. • Check the aerial/cable connection. • Keep the aerial/cable TV cable away from other connecting cables. |
| The TV turns off automatically (the TV enters standby mode). | <ul style="list-style-type: none"> • Check if the “Sleep Timer” is activated, or confirm the “Duration” setting of “On Timer” (page 33). • Check if the “Idle TV Standby” is activated (page 33). • Check if the “Presence Sensor” is activated (page 33). • If no signal is received and no operation is performed in the TV mode for 10 minutes, the TV automatically switches to standby mode. |
| The TV turns on automatically. | <ul style="list-style-type: none"> • Check if the “On Timer” is activated (page 33). |

| Condition | Explanation/Solution |
|--|---|
| Some input sources cannot be selected. | <ul style="list-style-type: none"> • Select “AV Preset” and cancel the “Skip” setting for the input source (page 39). |
| The remote does not function. | <ul style="list-style-type: none"> • Replace the batteries. |
| You have a blank TV listings in the GUIDE Plus+ System | <ul style="list-style-type: none"> • Check the aerial/cable connection. • Your cabling and set-up is OK, but your GUIDE Plus+ System was not connected for enough time to receive TV listings data. Leave the TV “STANDBY” overnight (24 hours) or use “Manual Data Download” (page 19) . • You live in a country/region where the GUIDE Plus+ System is not yet available. Check the list of countries to see if you are in a region that is supported. http://www.europe.guideplus.com/ |
| HDMI equipment does not appear on “HDMI Device List”. | <ul style="list-style-type: none"> • Check that your equipment is compatible with Control for HDMI. |
| You cannot select “Off” in “Control for HDMI”. | <ul style="list-style-type: none"> • If you have connected any audio system that is compatible with Control for HDMI, you cannot select “Off” in this menu. If you want to change the audio output to the TV speaker, select “TV Speaker” in the “Speaker” menu (page 38). |
| Not all channels are tuned for cable. | <ul style="list-style-type: none"> • Check the support website for cable provide information. http://support.sony-europe.com/TV/DVBC/ |

Keep this important information about how to re-tune your TV during the digital TV switchover

Keep this Instruction manual safe you'll need it

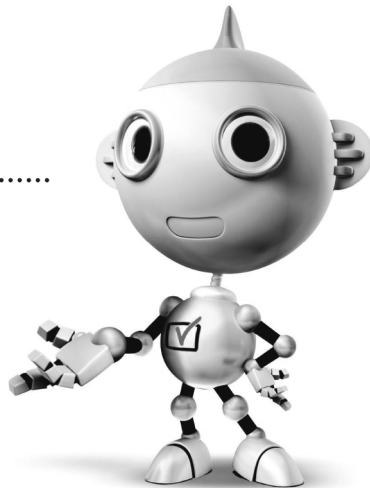

Television in the UK is going digital, bringing us all more. Please see overleaf to find out when your area switches to digital. Digital UK is the independent, non-profit organisation leading the process of digital TV switchover in the UK. Digital UK provides impartial information on what people need to do to prepare for the move to digital, and when they need to do it.

How the switchover affects your TV equipment:

Your new TV has a digital tuner built in, which means it is ready to receive the Freeview signal by simply plugging it into your aerial socket (check if you can get digital TV through your aerial now, or whether you'll have to wait until switchover, at www.digitaluk.co.uk).

When the TV switchover happens in your area, there are at least two occasions when you will need to re-tune your TV in order to continue receiving your existing TV channels, and also to pick up new ones. Digital UK, the body leading the digital TV switchover, will advise you when you need to re-tune during the switchover.

How to re-tune:

- 1 Press "**HOME**" on the remote
- 2 Press ⇐/⇒ to select "Settings"
- 3 Press ⇐/⇒ to select "Digital Set-up", then press ⊕
- 4 Press ⊕ to select "Digital Auto Tuning"
- 5 Press ⇐ to select "Yes" then press ⊕ to start "Digital Auto Tuning"
- 6 Follow the on screen instructions.

If you are missing any channels, it may be that they are not available in your area, or that your aerial needs upgrading.

If you have any questions, please contact Sony on **08705 111 999** or call Digital UK on **0845 6 50 50 50** or visit **www.digitaluk.co.uk**

When does switchover happen?

*Copeland switches on October 17, 2007



The exact date you switch depends on the transmitter you are served by. To check when you switch, go to Digital UK's postcode checker on www.digitaluk.co.uk Check your ITV news service or look at Teletext page 106 to see what TV region you're in.

Visit us at digitaluk.co.uk call us on **0845 6 50 50 50†**

†Calls charged at BT rate of 3p per minute daytime and 1p per minute evenings and weekends. Rates may vary for calls from non-BT lines.

Index

Numerics

- 1 Digit Direct 40
- 14:9 16
- 4:3 16
- 4:3 Default 37

A-G

- Add to Slideshow 30
- Adv. Contrast Enhancer 35
- Advanced Settings 35
- AFT 42
- Analogue Set-up 40
- AppliCast 29
- Audio Filter 42
- Audio Out 38
- Audio Settings 38
- Audio Set-up 42
- Auto Adjustment 38
- Auto Clock Update 33
- Auto Format 37
- Auto Light Limiter 35
- Auto Start-up 40
- Auto Tuning
 - analogue channels only 40
 - digital channels only 42
- Auto Volume 36
- AV Preset 39
- AV2 Input 39
- AV2 Output 39
- Backlight 34
- Balance 36
- Bass 36
- Batteries, inserting into the remote 4
- Black Corrector 35
- BRAVIA Sync 27
- BRAVIA Tips 33
- Brightness 34
- CA Module Set-up 44
- Cancel Timer 20
- Category list 20
- Channels
 - selecting 15
 - Skip 42
- Clear White 35
- Clock/Timers 33
- Colour 34
- Colour System 38
- Colour Temperature 35
- Confirm 42
- Connecting
 - an aerial 5
 - network 28
 - optional equipment 22
 - Set Top Box/recorder 5
- Contrast 34
- Control for HDMI 27, 40
- Digital Set-up 42
- Digital Tuning 42
- Display a photograph with the location on the map 26
- Display Area 37

- Display map 26
- Dual Sound 37
- Duration 25
- Eco 33
- EPG (Digital Electronic Programme Guide) 20
- Factory Settings 40
- FasText 15
- Favourite list 21
- Favourite Set-up 40
- Film Mode 35
- Gamma 35
- GUIDE Plus+ 17

H-Q

- HDMI Set-up 40
- Headphones
 - connecting 23
 - Headphone Settings 38
- Horizontal Shift 37, 38
- Hue 34
- Idle TV Standby 33
- Initial Set-up 6
- Installing the accessories 45
- Instruction Manual 33
- Intelligent Picture 41
- Label 42
- Language 40
- Light Sensor 14, 34
- Live Colour 35
- LNA 42, 43
- Manual Programme Preset 41
- Motionflow 35
- MPEG Noise Reduction 35
- Music 25, 29
- Network 44
 - connecting 28
- Network connection 30
- Network Settings 44
- Noise Reduction 35
- On Timer 33
- Optical Out 38
- PAP 24
- Parental Lock 43
- PC Power Management 33
- Phase 38
- Photo 25, 29
 - GPS 26
- Picture 34
- Picture Frame 25
- Picture Mode 34
- Picture Off (⊗) indicator 14
- PIN Code 43
- PIP 24
- Pitch 38
- Power (⏻) indicator 14
- Power (⏻) switch 10
- Power Saving 33
- Presence Sensor 14, 33
- Product Information 40
- Programme Labels 41
- Programme List Display 40
- Programme Sorting 41
- Quick Start 39

R-Z

- Radio Display 43
- Reminder 18, 20
- Remote control 10
 - inserting batteries 4
 - sensor 14
- Renderer 30
- Renderer Access Control 44
- Renderer Function 44
- Renderer Set-up 44
- Reset
 - Eco 33
 - PC settings 38
 - picture 34
 - sound 36
- SCENE 11
- Screen
 - for inputs other than a PC 37
 - for PC input 38
- Screen Format 16, 37, 38
- Server Diagnostics 44
- Server Display Settings 31, 44
- Set-up 39
- Sharpness 35
- Skip 42
- Sleep Timer 33
- Smart 16
- Sound 36
- Sound Booster 36
- Sound Enhancer 36
- Sound Mode 36
- Speaker 38
- Specifications 48
- Standby (⏻) indicator 14
- Subtitle Set-up 42
- Surround 36
- System Update 33
- Target Inputs
 - picture 34
 - screen 37
 - sound 36
- Technical Set-up 43
- Text
 - Digital 15
 - Analogue 16
- Timer (⌚) indicator 14
- Treble 36
- Troubleshooting 51
- TV buttons/indicators 10
- USB Auto Start 39
- Vertical Shift 37, 38
- Vertical Size 37
- Video 25, 29
- Video Settings 38
- Voice Zoom 36
- Volume Offset 36
- Volume 16
- XMB™ (XrossMediaBar) 32
- Zoom 16